

BRAVIS

LED ТЕЛЕВІЗОР

Інструкція з експлуатації

LED-28C2000B

LED-32C2000B

LED-39C2000B

LED-42C2000B



Дякуємо Вам за Ваш вибір!

Warning



CAUTION
RISK OF ELECTRIC SHOCK
DO NOT OPEN



WARNING:

TO REDUCE THE RISK OF ELECTRIC SHOCK DO NOT REMOVE COVER (OR BACK). NO USER SERVICEABLE PARTS INSIDE. REFER TO QUALIFIED SERVICE PERSONNEL.



The lightning flash with arrowhead symbol, within an equilateral triangle, is intended to alert the user to the presence of uninsulated "dangerous voltage" within the products enclosure that may be of sufficient magnitude to constitute a risk of electric shock to persons.



The exclamation point within an equilateral triangle is intended to alert the user to the presence of important operating and maintenance (servicing) instructions in the literature accompanying the appliance.

REGULATORY INFORMATION

This equipment generates uses and can radiate radio frequency energy and, if not installed and used in accordance with the instructions, may cause harmful interference to radio communication. However, there is no guarantee that interference will not occur in a particular installation. If this equipment does cause harmful interference to radio or television reception, which can be determined by turning the equipment off and on, the user is encouraged to try to correct the interference by one or more of the following measures:

- Relocate the receiving antenna.
 - Increase the separation between the equipment and receiver.
 - Connect the equipment into an outlet on a circuit different from that to which the receiver is connected.
 - Consult the dealer or experienced radio/TV technician for help.
- Any changes or modifications not expressly approved by the party responsible for compliance could void the user's authority to operate the equipment.

CAUTION

DO not attempt to modify this product in any way without written authorization from supplier. Unauthorized modification could void the user's authority to operate this product.

It is not recommended to keep a certain still image displayed on the screen for a long time as well as displaying extremely bright images on screen.

Figures and illustrations in this User Manual are provided for reference only and may differ from actual product appearance. Product design and specifications may be changed without notice.

Warning

WARNING

To Reduce The Risk Of Fire Or Electric Shock, Do Not Expose This Apparatus To Rain Or Moisture.

The ventilation should not be impeded by covering the ventilation openings with items, such as newspapers, table-cloths, curtains, etc.

The Apparatus shall not be exposed to dripping or splashing and that no objects filled with liquids, such as vases, shall be placed on the apparatus.

Attention should be drawn to the environmental aspects of battery disposal. Don't throw used batteries in dustbin. Please contact your retailer in order to protect the environment.

When you install your TV, maintain a distance of at least 4 inches between the TV and other objects (walls, cabinet sides, etc.) to ensure proper ventilation.

Failing to maintain proper ventilation may result in a fire or a problem with the product caused by an increase in its internal temperature.

No naked flame sources, such as lighted candles, should be placed on the apparatus;

To prevent the spread of fire, keep candles or other open flames away from this product at all times.

The device may be malfunction when under electrostatic discharge. It can be manually resumed by power off and power on again.

Warning: To avoid any injury caused by overturn of the product, please always ensure the whole product was placed within the table surface in horizontal.

CAUTION connecting the Power Cord

Most appliances recommend they be placed upon a dedicated circuit; that is, a single outlet circuit which powers only that appliance and has no additional outlets or branch circuits.

Do not overload wall outlets. Overloaded wall outlets, loose or damaged wall outlets, extension cords, frayed power cords, or damaged or cracked wire insulation are dangerous. Any of these conditions could result in electric shock or fire. Periodically examine the cord of your appliance, and its if appearance indicates damage or deterioration, unplug it, discontinue use of the appliance, and have the cord replaced with an exact replacement part by an authorized servicer. Protect the power cord from physical or mechanical abuse, such as being twisted, kinked, pinched, closed in a door, or walked upon. Pay particular attention to plugs, wall outlets, and the point where the cord exits the appliance.

The MAINS plug is used as the disconnect device, and the disconnect device shall remain readily operable.



This equipment is a Class II or double insulated electrical appliance. It has been designed in such a way that it does not require a safety connection to electrical earth.

Operating Temperature: 0°C to 40°C / Operating Humidity: ≤80%

Storage Temperature: -20°C to 60°C/Storage Humidity: ≤90%

Safety instructions

IMPORTANT SAFETY INSTRUCTIONS

1. Read these instructions.
2. Keep these instructions.
3. Heed all warnings.
4. Follow all instructions.

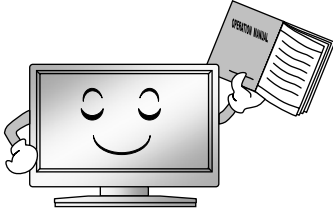

7. Do not block any of the ventilation openings. Install in accordance with the manufacturer's instructions.



5. Do not use this apparatus near water.



8. Do not install near any heat source such as radiators, heat registers, stoves, or other apparatus (including amplifiers) that produce heat.

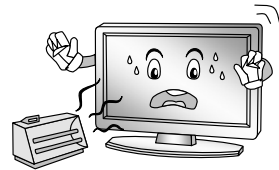

6. Clean only with a dry cloth.

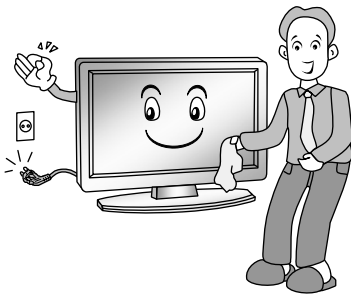

9. Do not defeat the safety purpose of the polarized or grounding type plug. A polarized plug has two blades with one wider than other. A grounding type plug has two blades and a third grounding prong. The wide blade or the third prong is provided for your safety. When the provided plug does not fit into your outlet, consult an electrician for replacement of the obsolete outlet.

Safety instructions

10. Protect the power cord from being walked on or pinched particularly at plugs, convenience receptacles, and the point where they exit from the apparatus.



13. Unplug this apparatus during lightning storms or when unused for long periods of time.

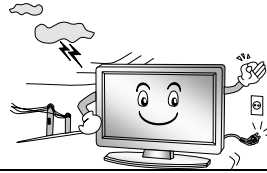

11. Only use the attachments/ accessories specified by the manufacturer.

12. Use only with a cart, stand, tripod, bracket, or table specified by the manufacturer, or sold with the apparatus. When a cart is used, use caution when moving the cart/ apparatus combination to avoid injury from tip-over.



14. Refer all servicing to qualified service personnel. Servicing is required when the apparatus has been damaged in any way, such as power supply cord or plug is damaged, liquid has been spilled or objects have fallen into the apparatus, the apparatus has been exposed to rain or moisture, does not operate normally, or has been dropped.



ON DISPOSAL

- The fluorescent lamp used in this product contain a small amount of mercury.
- Do not dispose of this product with general household waste.
- Disposal of this product must be carried out in accordance to the regulations of your local authority.

NOTE

- If the TV feel cold to the touch, there may be a small "flicker" when it is turned on. This is normal, there is nothing wrong with TV.
- Some minute dot defects may be visible on the screen, appearing as tiny red, green, or blue spots. However there have no adverse effect on the monitor's performance.
- Avoid touching the screen or holding your finger(s) against it for long periods of time. Doing so may produce some temporary distortion effect on the screen.

Getting Started

Using the remote control

When using the remote control, aim it at remote sensor on the television. If there is an object between the remote control and the remote sensor on the unit, the unit may not operate.

- ◆ Point the remote control at the REMOTE SENSOR located on the television.
- ◆ When using this television in a very brightly lit area, the infrared REMOTE CONTROL SENSOR may not work properly.
- ◆ The recommended effective distance for using the remote control is about 7 metres.

Installing Batteries in the Remote Control

1. Open the cover at the back of the remote control.
2. Install two AAA size batteries. Make sure to match the "+" and "-" ends of the batteries with the diagram inside the compartment.
3. Replace the cover.

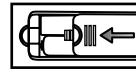
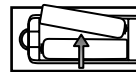
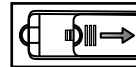

Battery replacement

You will need to install the batteries into the remote control to make it operate following the instruction below.

When the batteries become weak, the operating distance of the remote control will be greatly reduced and you will need to replace the batteries.

Notes on Using Batteries:

The use of the wrong type of batteries may cause chemical leakage and/or explosion. Please note the following:

- ◆ Always ensure that the batteries are inserted with the + and - terminals in the correct direction as shown in the battery compartment.
- ◆ Different types of batteries have different characteristics. Do not mix different types.
- ◆ Do not mix old and new batteries. Mixing old and new batteries will shorten battery life and/or cause chemical leakage.
- ◆ Replace batteries as soon as they do not work.
- ◆ Chemicals which leak from batteries may cause skin irritation. If any chemical matter seeps out of the batteries, wipe it up immediately with a dry cloth.
- ◆ The batteries may have a shorter life expectancy due to storage conditions. Remove the batteries whenever you anticipate that the remote control will not be used for an extended period.
- ◆ The batteries (battery pack or batteries installed) shall not be exposed to excessive heat such as sunshine, fire or the like.









CAUTION:

- ◆ It may result in an explosion if batteries are replaced incorrectly.
- ◆ Only replace batteries with the same or equivalent type.

Connection and setup

Connection

Turn off and unplug all components before making connections.
Do not turn on the TV until connection setup is completed.

Input Connector	Video Connection	Audio Connection	High or Standard Definition Quality
AV	 <p>Composite video connector</p>	 <p>Audio L/R</p>	576i, 480i (SD content)
Component	 <p>Component connection</p>	 <p>Audio L/R</p>	1080p, 1080i, 720p, 576p, 576i, 480p, 480i (Compatible with HD or SD content)
HDMI	 <p>HDMI connection</p>	HDMI cable carries both video and audio signals. Separate audio cable is not needed. (When HDMI is connected to DVI with an adapter, a separate audio L/R is necessary)	1080p, 1080i, 720p, 576p, 576i, 480p, 480i, PC (Compatible with HD or SD content)
PC	 <p>PC connection</p>	 <p>PC audio</p>	1920×1080(60Hz)
	Connection		
USB	<p>USB connection</p> 		USB2.0
RF	<p>RF connection</p> 		75Ω

Connection and setup

Cable Installation

Before the installation and use, please read carefully the relevant content in “Warning and Safety instructions”.

1. Take out the TV from the wrapping package and put it in a drafty and flat place.

NOTE:

- When you plug or unplug the TV, computer or other equipments, you must make sure that the AC power has been already shut down;
- When unplugging the power cable or signal cable, please hold the plug (the insulated part), do not draw the body of the cable.

2. The RF output terminal can be connected with the RF input port of the TV.

3. The output AV terminal of DVD can be connected with the AV input port of the TV through AV cable.

NOTE:

- YPbPr and AV can not be used at same time for they share of one audio channel.

4. The output COMPONENT(YPbPr) terminal of DVD can be connected with the COMPONENT(YPbPr) input port of the TV through AV cable.

5. Connect one end of the VGA cable with the VGA port on computer, connect the other end of the VGA cable with the VGA port on the TV, and tighten the bolts clockwise on the each end of VGA cable.

NOTE:

- While connecting the 15-pin VGA, please do not insert the plug overexertedly, for fear the pin might be broken.

6. Connect one end of the HDMI cable with HDMI output port, connect the other end of the HDMI cable with the HDMI port on the TV.

NOTE:

- While connecting the HDMI, please aim at carefully, do not insert overexertedly, for fear the pin might be broken.

7. The AV output of the TV can be connected with the input port of other AV equipment through AV cable.

NOTE:

- AV OUT can output only TV/AV channels' audio/video signal.

8. Check and make sure that all AV cables are connected with the corresponding ports correctly.

9. Connect the AC power cable with 100-240V AC power supply.

NOTE :

- The range of power input for the TV is 100-240V/50Hz, 60Hz, do not connect the TV power input port with the AC power out of the above range.
- Please hold the insulated part of the plug when you are unplugging the power cable, do not touch directly the metallic part of the cable.

Remote Control

The buttons of the original remote control are as following:

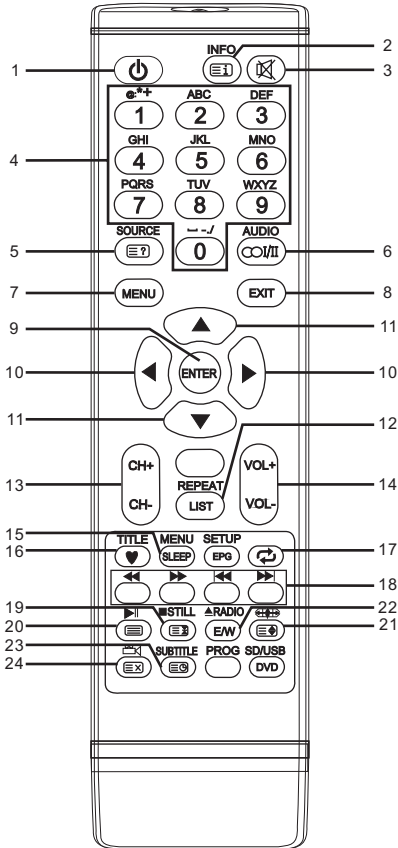





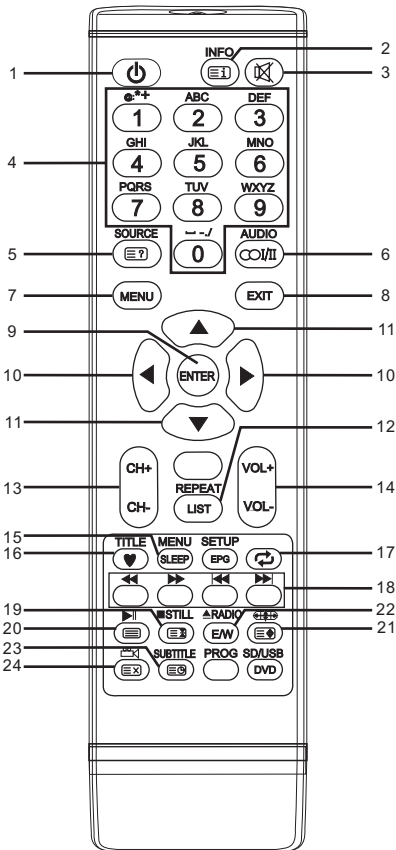

Definition of the buttons on remote control:

1. **POWER:** Enter or quit the standby mode.
2. **INFO:** Show info of current program.
3. **MUTE:** Mute or restore sound.
4. **NUMBER BUTTONS:** Use to choose channels. (in TV mode)
5. **SOURCE:** Select signal source.
6. **∞/II:** The button can be used to switch among DUAL I / DUAL II / DUAL I + II / MONO/stereo.
7. **MENU:** Press to display/disappear the on screen menus or to quit some operations.
8. **EXIT:** Quit the current interface.
9. **ENTER:** Select or confirm menu item.
10. **◀/▶:** Select direction.
11. **▲/▼:** Select direction.
12. **REPEAT:** Press to select the repeat play mode. (in USB mode)
13. **CH+/CH-:** Scroll to next/previous channel.
14. **VOL+/VOL-:** Increase/Decrease audio volume.
15. **SLEEP:** Set the sleep timer.
16. **♥:** Press to display the Favourites program in TV mode.(You should setup your favourite channels in Program Edit menu)
17. **↺:** Return to last viewed program/signal source.
18. **COLOR BUTTONS:**
Red/green/yellow/blue key navigation link.
 - ◀◀: Fast reverse (in USB mode)
 - ▶▶: Fast forward (in USB mode)
 - ◀◀◀: Previous (in USB mode)
 - ▶▶▶: Next (in USB mode)
19. **STILL:** Freeze or activate the current picture.
 - : Stop (in USB mode)
20. **▶||:** Play / Pause (in USB mode)
21. **⏏:** Adjust displayable aspect ratio.

Remote Control



Teletext Function:

2. **INDEX** : Go to the index page.
4. **NUMBER BUTTONS**: Key in the alphanumeric digits to go to the designated page directly.
5. **REVEAL** : Reveal or conceal hidden text for quizzes etc.
11. **▲/▼**: Press ▲/▼ to scroll to the next/previous page.
18. **COLOR BUTTONS**: Teletext Button.
19. **HOLD** : Retain the current teletext page and again to cancel the function.
20. **TEXT** : Switch between teletext on, mix and teletext off.
21. **SIZE** : Switch between zooming to the upper half, lower half and in full.
22. **E/W**: Switch between different languages.
23. **SUBTITLE** : Switch between secondary pages by entering the four digit number.
24. **CANCEL** : Cancel the teletext but not to exit teletext, press again to show teletext.

NOTE:

- ◆ All pictures in this manual are examples, only for reference, actual product may differ from the pictures.
- ◆ The buttons not mentioned here are not used.

Basic Operation

Turning on and off the TV

- **Turn on the TV**

Connect the TV to your mains socket.

If TV has a power switch, turn it on firstly. In standby mode, press  Power button on the remote to turn on the TV.

- **Turn off the TV**

Press the  button on the remote control to enter standby mode.

Do not leave your TV in standby mode for long periods of time. It is best to unplug the power cord.

NOTE:

- If there is an accident power off, the TV will be in standby mode automatically after re-supply the power. To ensure the normal use of the TV, the frequent turning on and off is forbidden, when there is an accident power off, it is recommended to unplug the power cable from the power socket.

- **No signal**

When the TV is working in RF receiving mode, the TV will enter standby mode automatically 5 minutes after there is no any signal (such as the programs are stopped by TV station). In PC-RGB mode, the TV set will automatically turn off in 30 seconds if no signal. When VGA cable is connected, the TV turns on automatically.

Programme Selection

- **Using the CH+/CH- on the panel of TV or on the remote control.**

Press CH+ to increase channel number.

Press CH - to decrease channel number.

- **Using 0-9 digital buttons.**

You can select the channel number by pressing 0 to 9.



Additionally, when TV is in some mode, the TV will work in TV mode and play the corresponding channel if any number button is pressed.

- **Example**

To select - channel (e.g. Channel 5): Press 5.

To select -- channel (e.g. Channel 20): Press 2 and 0 in a short time.

Volume adjustment

- Press the **VOL+/-** button to adjust the volume.
- If you want to switch the sound OFF, press the .
- You can release mute by pressing the  or increase the volume.

Changing the Input Source

You can select the input source by pressing the **SOURCE** button on the remote control.

Press the  button to cycle through the input source, and press the **ENTER** button to confirm your choice.

Menu Operation

How to Navigate Menus

Before using the TV follow the steps below to learn how to navigate the menu in order to select and adjust different functions. The access step may differ depending on the selected menu.

1. Press the **MENU** button to display the main menu.
2. Press the **◀/▶** button to cycle through the main menu, then press **ENTER** button or **TV/AV** () button on the panel to confirm.
3. Press the **▲/▼** button to select the desired sub item.
4. Press the **ENTER** button to access the submenu.
5. Press the **▲/▼/◀/▶** button to select the desired value. The adjustment in the OSD may differ depending on the selected menu.
6. Press the **MENU** button to return to the previous menu.
7. Press the **EXIT** button exit from the menu.

NOTE:

- When an item in MENU is displayed gray, it means that the item is not available or cannot be adjusted.
- Buttons on the TV have the same function as corresponding buttons on the remote control. If your remote control is lost or couldn't work, you may use the buttons on the TV to select menus. This manual focuses on operation of the remote control.

Configuring the Channel Menu

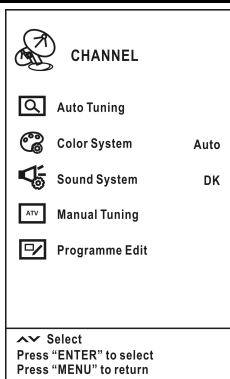

Auto Tuning	Press the ENTER button to start Auto tuning which automatically scan and store all available programmes.
Color System	To select the Color System.
Sound System	To select the Sound System.
Manual Tuning	Manual Tuning lets you manually tune and arrange the stations in whatever order you desire.
Programme Edit	<p>Press ▲/▼ button select items.</p> <p>Press red button to delete the channel.</p> <p>Press green button to rename the channel.</p> <p>Press yellow button to move the channel.</p> <p>Press blue button to skip the channel.</p> <p>Press ♥ button to set the favorite channel.</p> <p>The CH+/CH- button can be used to select the following or preceding page.</p>

Menu Operation

Configuring the Picture Menu

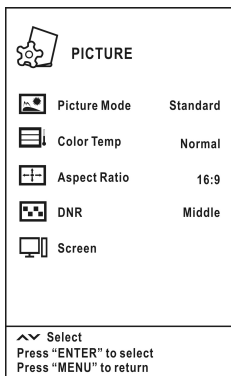

Picture Mode	You can select the type of picture which best corresponds to your viewing requirements. Contrast, Brightness, Saturation, Sharpness and Tint (NTSC) can be adjusted when the Picture Mode is set to User.
Color Temp	Select the color temperature of the picture.
Aspect Ratio	You can select the picture size which best corresponds to your viewing requirements.
DNR	Reduce the picture noise (snowy picture) in a weak broadcast signal.
Screen (In PC-RGB mode)	If the TV is used as the display terminal, the output mode of computer 1280 x1024(60Hz) is recommended, thus allow you to have the best performance of the TV. Auto Adjust: Adjust the image automatically. H Position: Centre the image by moving it left or right. V Position: Centre the image by moving it up or down. Size: Adjust the screen size. Phase: Adjust when characters have low contrast or when the image flickers.

Configuring the Sound Menu

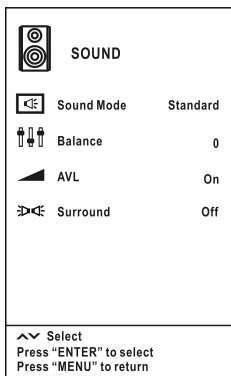

Menu Operation

Sound Mode	You can select a sound mode to suit your personal preferences. Items can be adjusted when the sound mode is set to User.
Balance	You can adjust the sound balance of the speakers to preferred levels.
AVL	AVL automatically remains on the same level of volume if you change programmes. Because each broadcasting station has its own signal conditions, volume adjustment may be needed every time when the channel is changed. This feature allows users to enjoy stable volume levels by making automatic adjustments for each program.
Surround	To switch the surround sound.

Configuring the Timer Menu

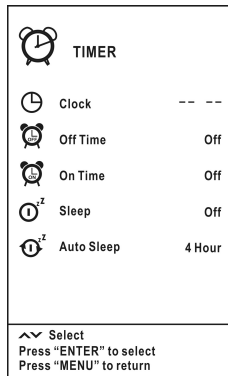

Clock	Set the System Time. You must set the time correctly before using on/off timer function.
Off Time	Set the time for the TV to switch off. On time and Off time can not be set to the same time, and they do not work in operating menu.
On Time	Set the time for your TV to turn on.
Sleep	Select the time to turn the TV to standby mode automatically.
Auto Sleep	Select the Auto Sleep time you want. The Auto Sleep switches the TV to standby automatically after the preset time has elapsed. (the preset time is 4 hours when leave the factory). All the Timer Menu options but Clock and Auto Sleep are not available in USB mode.

Menu Operation

Configuring the Option Menu

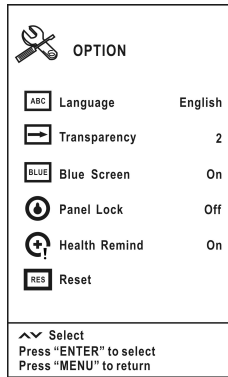

Language	Select your preferred On Screen Display language.	
Transparency	Select menu transparency according to different background pictures.	
Blue Screen		When there is no TV signal
	On	Blue Screen
	Off	Picture is spotted with snowflake
Panel Lock	When the Panel Lock is set as On, all of the buttons on the TV are locked and lose their function. To release Panel Lock, please press any button on the TV for more than 5 seconds. When you select this item as Off, the buttons on the TV are in normal mode.	
Health Remind	Switch the Health Remind on or off. While Health Remind is set to On, a prompt picture will remind you to have a break at intervals of two hours.	
Reset	Restore the system settings to the factory default.	

Menu Operation

Using USB mode

• To Access/Quit USB mode

Press the **SOURCE** button to call up the signal source selection menu. Use the ▲/▼ to highlight USB, and the **ENTER** button to access the USB mode. You may also use the signal source selection menu to exit from the USB mode.

NOTE:

- ◆ Special USB device may be not or well supported.
- ◆ USB max. Load: DC5V 500mA.

• The formats supported

The USB function can support the USB device with USB memory.

It can play PHOTO, MUSIC, MOVIE or TEXT files.

Photo Format Support: JPEG, BMP, PNG.

Music Format Support: WMA, MP3, M4A (AAC) .

Movie Format Support: MPG, RM.

Text Format Support: TXT.

NOTE:

- ◆ Special algorithm documents may not be or well be supported by the USB.
- The USB supports the format mentioned above, if the file format is not supported, change it to the given format.
- ◆ Video decoder supports H.264.

• Main Operating Interface

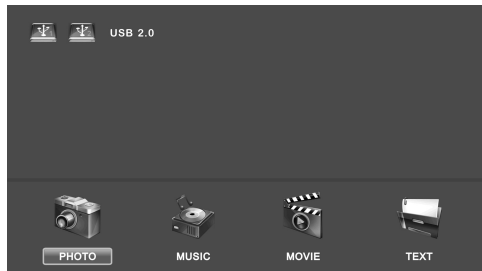

1. Use the ◀/▶ button to select PHOTO, MUSIC, MOVIE or TEXT. Press **ENTER** button enter into sub-menu.
2. Use the arrow buttons and **ENTER** button to enter the desired disk. Press **ENTER** to open the folder.
3. Use the arrow buttons to highlight the file. Use the **ENTER** button to mark or unmark a file. Press ▶| button to play the selected files. If no file is marked, all the files in the folder will be played in sequence after you press ▶| button.
4. Press the **INFO** button to display the menu screen in playing.
5. Press the ■ to stop the playing files.
6. Press the **EXIT** button to return to the previous menu screen.

Menu Operation

• Basic operation

1. ▶|| Play/ Pause

Start playing the selected file of a folder or pause.

2. ■ Stop

Stop the playing files.

3. ◀/▶ Fast Reverse/Fast Forward

You can press ◀/▶ to skip fast reverse or forward.

4. ◀◀/▶▶ Previous/Next

You can select the desired files manually in normal condition.

5. Red button

Select a file you want to delete, press the red button to open corresponding menu, then press **ENTER** button to delete it.

6. CH+/CH-

When view the TEXT files, press CH+/CH- to change pages up and down.

7. CH+/CH- on the TV

In the USB mode, use the CH+/CH- button on the TV as you would use the **ENTER** button on the remote control.

Press the CH+/CH- button on the TV for more than 3 seconds to start playing the selected file.

8. VOL+/VOL- on the TV

When selecting files, use the VOL+/VOL- button on the TV as you would use the ◀/▶ button on the remote control.

When playing files, use the VOL+/VOL- button on the TV as you would use the VOL+/VOL- button on the remote control.

Troubleshooting Guide

Troubleshooting

When you meet the following common problems, you might diagnose and get the solutions without contacting with the technicians.

Symptoms	Possible Reason	Solutions
No picture, no sound, and no indicator light on	<ol style="list-style-type: none"> 1.The power cord is not plugged in 2.The power is off 	<ol style="list-style-type: none"> 1.Plug the power cord in 2.Turn the power on
Picture and sound with abnormality	<ol style="list-style-type: none"> 1.Contrast, sharpness, and color are set improperly 2.Color system is set improperly 3.Sound system is set improperly 	<ol style="list-style-type: none"> 1.Adjust the value of Contrast, sharpness, and color 2.Set the Color system to the country broadcasting standard 3.Set the Sound system to the country broadcasting standard
Picture is spotted or with snow	Signal source is low-grade or the signal cord is in a lower quality	Use the qualified signal cord
No picture, no sound and indicator light is green/blue	Volume is in the minimum value or TV is in mute mode.	Adjust the value of volume
	The signal cable is not correctly connected.	Connect the signal cable correctly
Blue screen, AV is displayed	There is no signal input or the video cable is not connected or incorrectly connected	Connect the video cable correctly
Picture is unclear or shaking or with black horizontal strips (in PC mode)	PC picture is not correctly adjusted.	Enter into Screen menu, select Auto Adjust item to perform automatic calibration and adjust Phase to solve the problem
PC picture is not centered		
No sound	There is no audio signal input or audio cable is not connected correctly	Connect the audio cable correctly
PC picture display with improper color	The color temp is adjusted incorrectly by user	Readjust the color temp, or select the original color setting
HDMI source, with snow pixel of full screen	The source generate is not standard	Plug the HDMI cable again

Troubleshooting Guide

The remote control does not work	Batteries are improperly installed or exhausted	<ol style="list-style-type: none">1. Make sure the positive and the negative polarities are correct.2. Check if there is a loose contact between the batteries and the springs3. Replace the batteries
----------------------------------	---	--

Maintenance

Early malfunctions can be prevented. Careful and regular cleaning can extend the life of your new TV. Be sure to turn the power off and unplug the power cord before you begin any cleaning.

Cleaning the screen

1. Here's a great way to keep the dust off your screen for a while. Wet a soft cloth in a mixture of lukewarm water and a little fabric softener or dish washing detergent. Wring the cloth until it's almost dry, and then used it to wipe the screen.
2. Make sure the excess water is off the screen, and then let it air-dry before you turn on your TV.

Cleaning the cabinet

To remove dirt or dust, wipe the cabinet with a soft, dry, lint-free cloth. Please be sure not to use a wet cloth.

Extended Absence



If you expect to leave your TV dormant for a long time (such as a vacation), it's a good idea to unplug the power cord to protect against possible damage from lightning or power surges.

Disposal of old electrical appliances



The European directive 2012/19/EU on Waste Electrical and Electronic Equipment (WEEE), requires that old household electrical appliances must not be disposed of in the normal unsorted municipal waste stream. Old appliances must be collected separately in order to optimize the recovery and recycling of the materials they contain, and reduce the impact on human health and the environment.

The crossed out "wheeled bin" symbol on the product reminds you of your obligation, that when you dispose of the appliance, it must be separately collected.

Consumers should contact their local authority or retailer for information concerning the correct disposal of their old appliance.

