

Quick Installation Guide

Megapixel Surveillance Camera
Wireless N Megapixel Surveillance Camera

MODEL NO. TL-SC3230/TL-SC3230N

Package Contents

The product model shown in this QIG is TL-SC3230N, as an example.

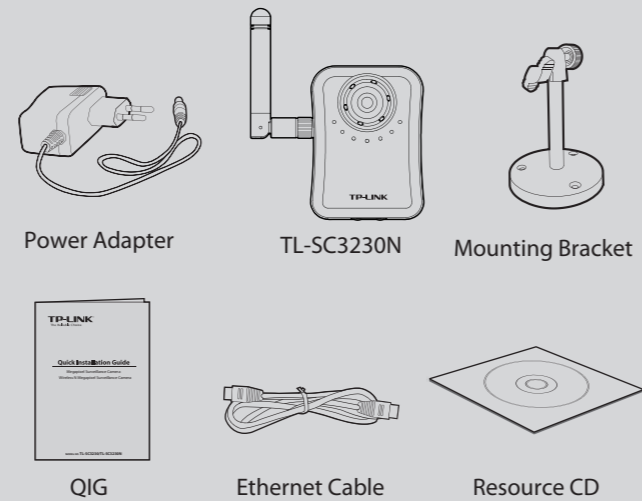

(*The pictures are for reference only.)

System Requirement

The following operating systems are supported:

- Windows 2000
- Windows 2003
- Windows XP
- Windows Vista
- Windows 7

The following browsers are supported:

- Internet Explorer 8 or higher
- Safari
- Firefox
- Chrome

(*Internet Explore Browser is recommended.)

1 Warning Before Installation

- Do not keep the Camera exposed to direct sunlight.

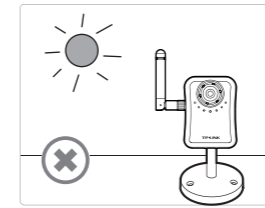

- Do not place the Camera in high humidity environments such as in a kitchen.

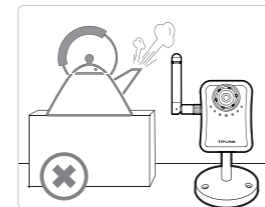

- Do not place the Camera where there are high temperatures such as near an oven.

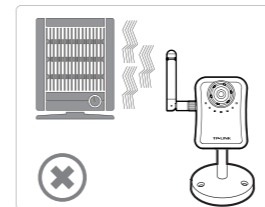

- Do not place the Camera near devices that emit radio waves, such as mobile phones.



* It is recommended to mount the Camera where objects often pass, and the direction towards the door or passage is much better, see the illustration below:

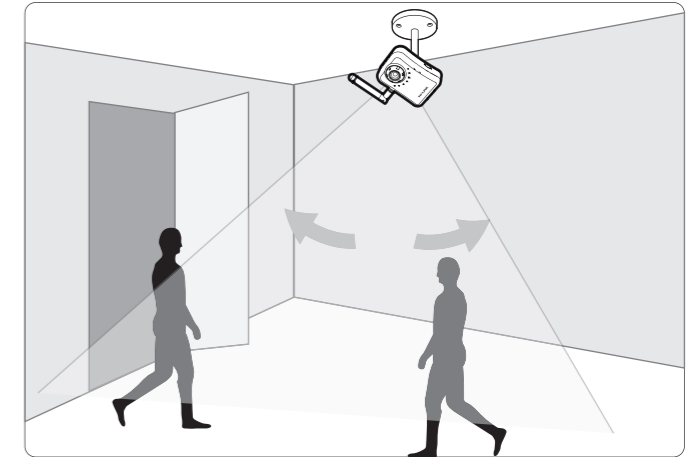

2 Physical Description

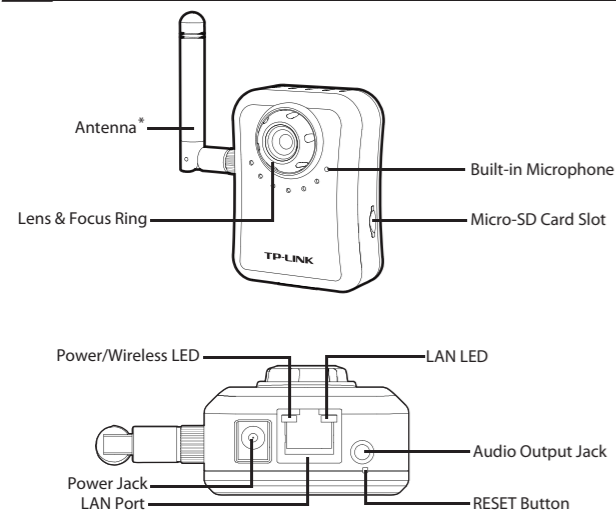

LED	Status	Description
Power/Wireless LED	Off	The camera is powered off.
	Solid Orange	The camera finishes boot-up and is ready to serve. Power on the camera, the LED will light up and then go off to booting process. After keeping off for several seconds, the LED will be solid orange.
	Flash Orange*	The camera has been connected to a wireless network.
LAN LED	Solid Green	No cable is linked to the camera.
	Flash Green	Data is being transmitted or received.

Button	Description
RESET Button	While the camera is ready, press RESET button for at least 5 seconds and release it. The camera will be restored to default settings and reboot again.

* The Antenna and Flash Orange status are for TL-SC3230N only.

3 Hardware Connection

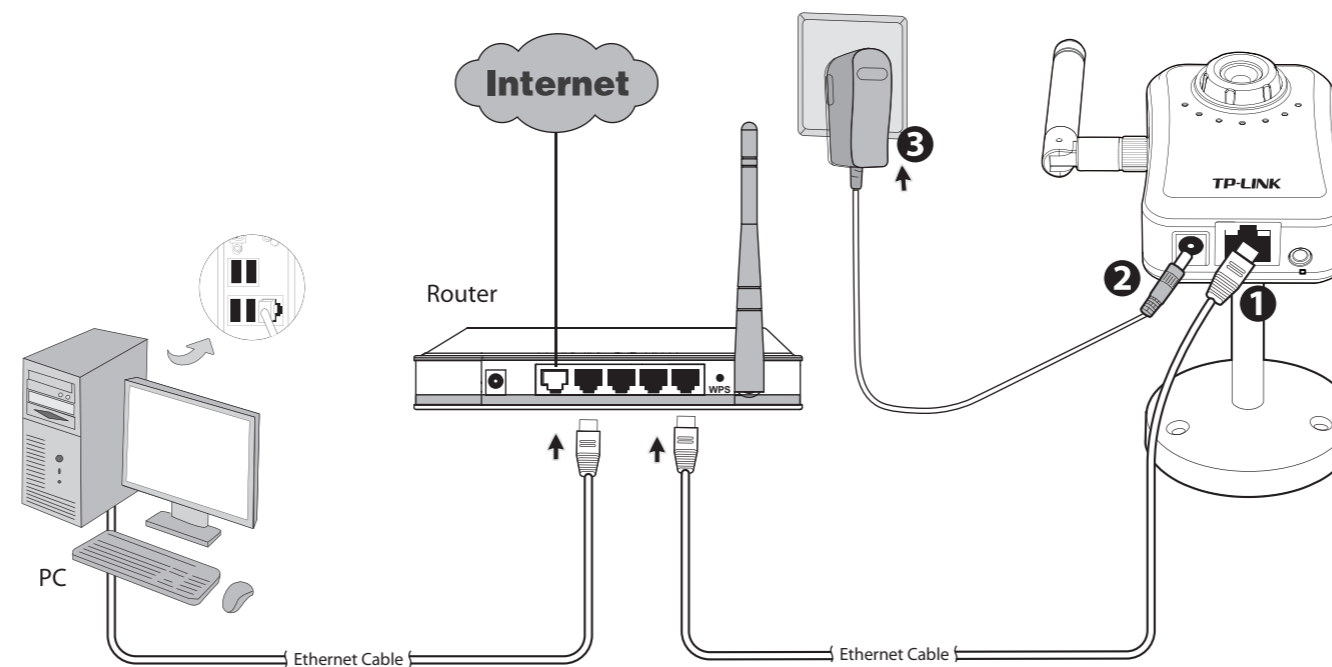

- 1 Connect the LAN port on Camera to the LAN Port of your router or switch with an Ethernet cable.
- 2 Connect the power adapter cord to the Power jack.
- 3 Plug the power adapter into the power outlet.

Note:

Before proceeding, confirm that your PC is connected to your Router and can access the Internet.

Make sure that your Router's DHCP feature is enabled. If not, please refer to your Router's instruction to enable it.

4 Software Installation

1 Insert the provided Resource CD into your CD-ROM drive.

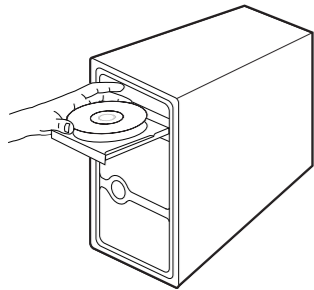

2 The Setup Wizard will automatically pop up, then click "IP Search Software".



* If the CD does not automatically run with the installation window appearing, find the CD drive in the "My Computer" space and run it directly there.

3 Click "Install IP Search Software", and the IP Search Software window will appear. Click "Next" to follow the wizard steps to install the software.

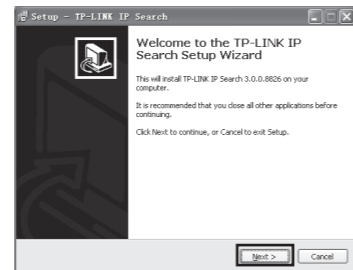

4 Click "Finish" to complete the setup and the icon of "IP Search" will display on the computer's Desktop.

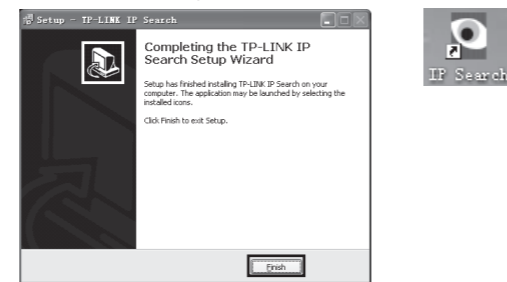

Note: Surveillance Manager software is provided on the CD for you to manage the camera. For detailed instruction, please refer to its user manual included.

5 Access the Camera Using IP Search

1 Click the icon of IP Search on the computer's Desktop.



Click "SEARCH", the main page will show up and list all active TP-LINK camera devices. Select the camera based on its MAC address, which can be found on its label.

Double click the selected camera and you will link to this camera by browser (or you can click "VIEW" to view the live video on the right corner of the page).

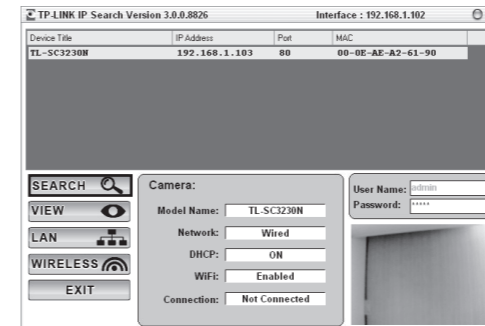

2 When you are accessing the Camera for the first time, a yellow information bar will appear at the bottom of the web page. Click the "Install" button. Then click "Install" at the prompt.

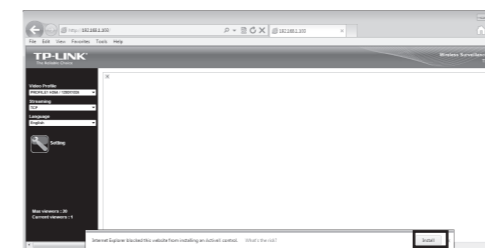

3 Live video will display in the center of your web browser.



4 If you want to configure the parameters of the camera, please click "Setting" on the web management page. Enter User name and Password to log onto the configuration page of the camera. (Default is admin / admin)

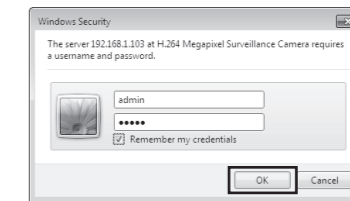

Note: If the information bar does not show up, please refer to **Troubleshooting**.

For advanced settings, please refer to the User Guide on the Resource CD.

Appendix: Configure the Camera via IP Search

With "IP Search", you can change the IP related parameters of wired interface and connect the camera to the wireless network quickly. Wireless setting is for TL-SC3230N only.

LAN Setting

1 Select the camera you want to configure and click the "LAN" button. Modify the relative settings of the selected device. Click "<<" button to quit the LAN setting procedure or click ">>" button to move to next page.

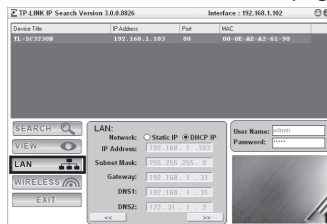

2 Change the login password. Tick the box and then key in a new username and password, and click "Submit" button to perform your settings accordingly. Click "<<" button to return to the previous page.

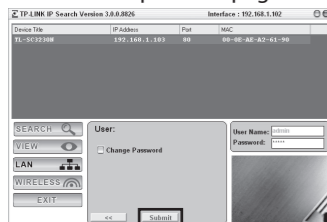

Wireless Setting

1 Select the camera you want to configure and click the "WIRELESS" button. Click SSID to select your wireless AP or router and key in WEP or WPA key. Click ">>" to confirm wireless setting and then submit your settings.

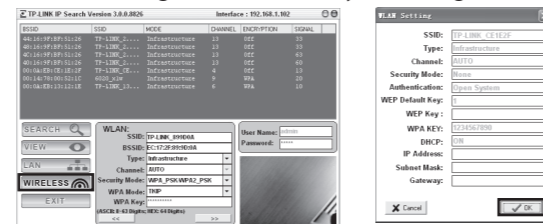

2 After taking the steps above, you will be prompted to unplug the Ethernet cable to activate wireless access. And you can select to test wireless settings or finish wireless procedure in the following figure.

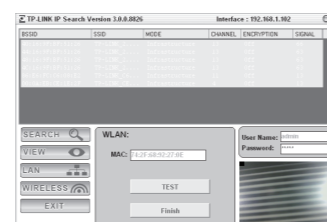

Troubleshooting

- What can I do if the information bar does not show up?**
Open an IE browser. Click "Tools", then "Internet options". Click "Security" -> "Internet" -> "Custom level...". Find the item "Download signed ActiveX controls" and set to "Prompt (recommended)", then click "OK". Click "Security" -> "Local intranet" -> "Custom level...". Find the item "Download signed ActiveX controls" and set to "Prompt", then click "OK".
- What can I do if I forget the login name and password?**
Keep the camera powered on, then press and hold the Reset button for more than 5 seconds. Afterwards release it, and the camera will be restored to factory defaults after reboot. Both the default name and password are admin.
- What can I do if I can't access the Camera?**
Make sure the Power LED is solid orange. If you can't find the IP address through IP Installer, please log into your router and find the camera's IP address in the DHCP Client list. If this still doesn't work, please reset the camera.
- What can I do if the video image flickers?**
Wrong power line frequency makes images flicker. Make sure the power frequency of your camera is 50 or 60Hz. If the object is dark, the image will flicker. Make the environment around the camera brighter.

For more details about Troubleshooting and Technical Support contact, please log onto our Technical Support Website.
<http://www.tp-link.com/en/support>

Technical Support

- For more troubleshooting help, go to www.tp-link.com/en/support/faq
- To download the latest Firmware, Driver, Utility and User Guide, go to <http://www.tp-link.com/en/support/download/>
- For all other technical support, please contact us by using the following details:
 - Global**
Tel: +86 755 26504400
E-mail: support@tp-link.com
Service time: 24hrs, 7 days a week
 - Australia / New Zealand**
Tel: AU 1300 87 5465
NZ 0800 87 5465
E-mail: support.au@tp-link.com (Australia)
support.nz@tp-link.com (New Zealand)
Service time: 24hrs, 7 days a week
 - Singapore**
Tel: +65 62840493
E-mail: support.sg@tp-link.com
Service time: 24hrs, 7 days a week
 - Turkey**
Tel: 444 19 25 (Turkish Service)
NZ 0800 87 5465
 - UK**
Tel: +44 (0) 845 147 0017
E-mail: support.uk@tp-link.com
Service time: 24hrs, 7days a week
 - USA / Canada**
Toll Free: +1 866 225 8139
E-mail: support.usa@tp-link.com
Service time: 24hrs, 7days a week
 - Ukraine**
Tel: 0-800-505-508
E-mail: support.ua@tp-link.com
Service time: Monday to Friday 14:00 PM to 22:00 PM
 - Brazil**
Toll Free: 0800-770-4337 (Portuguese Service)
E-mail: suporte.br@tp-link.com
Service time: Monday to Saturday 08:00 AM to 08:00 PM
 - Italy**
Tel: +39 0230519020
E-mail: support.it@tp-link.com
Service time: Monday to Friday, 9:00 AM to 6:00 PM, 2:00 PM to 6:00 PM
 - Indonesia**
Tel: (+62) 021 6259 135
E-mail: support.id@tp-link.com
Service time: Monday to Friday 9:00 -12:00; 13:00 -18:00 (Except public holidays)
 - Germany / Austria**
Tel: +49 1805 875465 (German Service)
+49 1805 TPLINK
E-mail: support.de@tp-link.com
Fee: 0.14 EUR/min from the German fixed phone network and up to 0.42 EUR/min from mobile phone.
Service Time: Monday to Friday, 9:00 AM to 6:00 PM, GMT+1 or GMT+2 (Daylight Saving Time in Germany)
* Except bank holidays in Hesse
 - France**
Tel: +33 (0) 820 800 860 (French service)
Email: support.fr@tp-link.com
Fee: 0.118 EUR/min from France
Service time: Monday to Friday 9:00 AM to 6:00 PM (Except French Bank holidays)
 - Russian Federation**
Tel: 8 (499) 754-55-60 / 8 (800) 250-55-60 (toll-free call from any RF region)
E-mail: support.ru@tp-link.com
Service time: From 10:00 to 18:00 (Moscow time)
*Except weekends and holidays in Russian Federation