

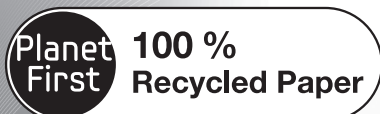

Microwave Oven

Owner's Instructions & Cooking Guide

Please be advised that the Samsung warranty does NOT cover service calls to explain product operation, correct improper installation, or perform normal cleaning or maintenance.



This manual is made with 100 % recycled paper.

ME81KR*-1 ME81KR*-2
ME81KR*-3 ME81MR**
ME81AR*

imagine the possibilities

Thank you for purchasing this Samsung product.



contents

Safety information	2
Oven features	11
OVEN (ME81KR*-1, ME81KR*-2, ME81KR*-3).....	11
OVEN (ME81MR**).	12
OVEN (ME81AR*).....	12
Control Panel (ME81KR*-1, ME81KR*-2, ME81KR*-3).....	13
Control Panel (ME81MR**).....	13
Control Panel (ME81AR*).....	14
Accessories.....	14
Oven use	15
Cooking/Reheating.....	15
Power levels.....	15
Stopping the cooking.....	15
Adjusting the cooking time.....	15
Manual defrosting food.....	15
Using the instant reheat feature.....	16
Instant reheat settings.....	16
Cookware guide	16
Troubleshooting	17
Technical specifications	18

safety information

USING THIS INSTRUCTION BOOKLET

You have just purchased a SAMSUNG microwave oven. Your Owner's Instructions contain valuable information on cooking with your microwave oven:

- Safety precautions
- Suitable accessories and cookware
- Useful cooking tips
- Cooking tips

LEGEND FOR SYMBOLS AND ICONS

 **WARNING** Hazards or unsafe practices that may result in **severe personal injury or death.**

 **CAUTION** Hazards or unsafe practices that may result in **minor personal injury or property damage.**

 Warning; Fire hazard

 Warning; Hot surface

 Warning; Electricity

 Warning; Explosive material

 Do NOT attempt.

 Do NOT touch.

 Do NOT disassemble.

 Follow directions explicitly.

 Unplug the power plug from the wall socket.

 Make sure the machine is grounded to prevent electric shock.

 Call the service center for help.

 Note

 Important

IMPORTANT SAFETY INSTRUCTIONS READ CAREFULLY AND KEEP FOR FUTURE REFERENCE.

Make sure that these safety precautions are obeyed at all times.

Before using the oven, confirm that the following instructions are followed.

WARNING

(Microwave function only)

- WARNING:** If the door or door seals are damaged, the oven must not be operated until it has been repaired by a competent person.
- WARNING:** It is hazardous for anyone other than a competent person to carry out any service or repair operation that involves the removal of a cover which gives protection against exposure to microwave energy.
- This appliance is intended to be used in household only.

 **WARNING:** Only allow children to use the oven without supervision when adequate instructions have been given so that the child is able to use the oven in a safe way and understands the hazards of improper use.

 **WARNING:** This appliance can be used by children aged from 8 years and above and persons with reduced physical, sensory or mental capabilities or lack of experience and knowledge if they have been given supervision or instruction concerning use of the appliance in a safe way and understand the hazards involved. Children shall not play with the appliance. Cleaning and user maintenance shall not be made by children unless they are aged from 8 years and above and supervised.

 Only use utensils that are suitable for use in microwave ovens.

 When heating food in plastic or paper containers, keep an eye on the oven due to the possibility of ignitions.

★	The microwave oven is intended for heating food and beverages. Drying of food or clothing and heating of warming pads, slippers, sponges, damp cloth and similar may lead to risk of injury, ignition or fire.
☞	If smoke is emitted, switch off or unplug the appliance and keep the door closed in order to stifle any flames.
★	WARNING: Microwave heating of beverages can result in delayed eruptive boiling, therefore care must be taken when handling the container.
★	WARNING: The contents of feeding bottles and baby food jars shall be stirred or shaken and the temperature checked before consumption, in order to avoid burns.
☒	Eggs in their shell and whole hard-boiled eggs should not be heated in microwave ovens since they may explode, even after microwave heating has ended.
★	The oven should be cleaned regularly and any food deposits removed.

☞	Failure to maintain the oven in a clean condition could lead to deterioration of the surface that could adversely affect the life of the appliance and possibly result in a hazardous situation.
☒	The appliance is not intended for installing in road vehicles, caravans and similar vehicles etc.
★	This appliance is not intended for use by persons (including children) with reduced physical, sensory or mental capabilities, or lack of experience and knowledge, unless they have been given supervision or instruction concerning use of the appliance by a person responsible for their safety.
★	Children should be supervised to ensure that they do not play with the appliance.
☞	If the supply cord is damaged, it must be replaced by the manufacturer, its service agent or similarly qualified persons in order to avoid a hazard.
☒	WARNING: Liquids and other foods must not be heated in sealed containers since they are liable to explode;

<input type="checkbox"/>	The appliance should not be cleaned with a water jet.
<input checked="" type="checkbox"/>	This oven should be positioned proper direction and height permitting easy access to cavity and control area.
<input checked="" type="checkbox"/>	Before using the your oven first time, oven should be operated with the water during 10 minute and then used.
<input checked="" type="checkbox"/>	If the oven generates a strange noise, a burning smell, or smoke is emitted, unplug the power plug immediately and contact your nearest service center.
<input checked="" type="checkbox"/>	The microwave oven has to be positioned so that plug is accessible.
<input type="checkbox"/>	The microwave oven is intended to be used on the counter or counter top use only, the microwave oven shall not be placed in a cabinet.

⚠ WARNING
(Oven function only) - Optional

<input checked="" type="checkbox"/>	WARNING: When the appliance is operated in the combination mode, children should only use the oven under adult supervision due to the temperatures generated.
-------------------------------------	----------------------------------------------------------------------------------------------------------------------------------------------------------------------

<input checked="" type="checkbox"/>	During use the appliance becomes hot. Care should be taken to avoid touching heating elements inside the oven.
<input type="checkbox"/>	WARNING: Accessible parts may become hot during use. Young children should be kept away.
<input type="checkbox"/>	A steam cleaner is not to be used.
<input type="checkbox"/>	WARNING: Ensure that the appliance is switched off before replacing the lamp to avoid the possibility of electric shock.
<input checked="" type="checkbox"/>	WARNING: The appliance and its accessible parts become hot during use. Care should be taken to avoid touching heating elements. Children less than 8 years of age shall be kept away unless continuously supervised.
<input type="checkbox"/>	The temperature of accessible surfaces may be high when the appliance is operating.
<input type="checkbox"/>	The door or the outer surface may get hot when the appliance is operating.
<input type="checkbox"/>	Keep the appliance and its cord out of reach of children less than 8 years.

★	This appliance can be used by children aged from 8 years and above and persons with reduced physical, sensory or mental capabilities or lack of experience and knowledge if they have been given supervision or instruction concerning use of the appliance in a safe way and understand the hazards involved. Children shall not play with the appliance. Cleaning and user maintenance shall not be made by children without supervision.
☐	Do not use harsh abrasive cleaners or sharp metal scrapers to clean the oven door glass since they can scratch the surface, which may result in shattering of the glass.
☐	Appliances are not intended to be operated by means of an external timer or separate remote-control system.

This product is a Group 2 Class B ISM equipment. The definition of group 2 which contains all ISM equipment in which radio-frequency energy is intentionally generated and/or used in the form of electromagnetic radiation for the treatment of material, and

EDM and arc welding equipment. For Class B equipment is equipment suitable for use in domestic establishments and in establishments directly connected to a low voltage power supply network which supplies buildings used for domestic purposes.

INSTALLING YOUR MICROWAVE OVEN

Place the oven on a flat level surface 85 cm above the floor. The surface should be strong enough to safely bear the weight of the oven.

1. When you install your oven, make sure there is adequate ventilation for your oven by leaving at least 10 cm (4 inches) of space behind and, on the sides of the oven and 20 cm (8 inches) of space above.
2. Remove all packing materials inside the oven.
3. Install the roller ring and turntable. Check that the turntable rotates freely. (Turntable type model only)
4. This microwave oven has to be positioned so that plug is accessible.

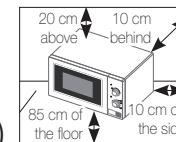

- ❑ If the supply cord is damaged, it must be replaced by the manufacturer, its service agent or similarly qualified persons in order to avoid a hazard.
For your personal safety, plug the cable into a proper AC earthed socket.
- ❑ Do not install the microwave oven in hot or damp surroundings like next to a traditional oven or radiator. The power supply specifications of the oven must be respected and any extension cable used must be of the same standard as the power cable supplied with the oven. Wipe the interior and the door seal with a damp cloth before using your microwave oven for the first time.

CLEANING YOUR MICROWAVE OVEN

The following parts of your microwave oven should be cleaned regularly to prevent grease and food particles from building up:

- Inside and outside surfaces
 - Door and door seals
 - Turntable and Roller rings
(Turntable type model only)
- ❑ **ALWAYS** ensure that the door seals are clean and the door closes properly.

- ❑ Failure to maintain the oven in a clean condition could lead to deterioration of the surface that could adversely affect the life of the appliance and possibly result in a hazardous situation.

1. Clean the outside surfaces with a soft cloth and warm, soapy water. Rinse and dry.
 2. Remove any splashes or stains on the inside surfaces of oven with a soapy cloth. Rinse and dry.
 3. To loosen hardened food particles and remove smells, place a cup of diluted lemon juice in the oven and heat for ten minutes at maximum power.
 4. Wash the dishwasher-safe plate whenever necessary.
- ❑ **DO NOT** spill water in the vents. **NEVER** use any abrasive products or chemical solvents. Take particular care when cleaning the door seals to ensure that no particles:
- Accumulate
 - Prevent the door from closing correctly

- ✎ **Clean** the microwave oven cavity right after each use with a mild detergent solution, but let the microwave oven cool down before cleaning in order to avoid injury.

When cleaning the upper part inside the cavity, it will be convenient to turn heater downward by 45 ° and clean it. (Swing heater model only)

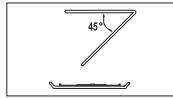

STORING AND REPAIRING YOUR MICROWAVE OVEN

A few simple precautions should be taken when storing or having your microwave oven serviced.

The oven must not be used if the door or door seals are damaged:

- Broken hinge
- Deteriorated seals
- Distorted or bent oven casing

Only a qualified microwave service technician should perform repair.

- ✎ **NEVER** remove the outer casing from the oven. If the oven is faulty and needs servicing or you are in doubt about its condition:

- Unplug it from the wall socket
- Contact the nearest after-sales service centre

- ✎ If you wish to store your oven away temporarily, choose a dry, dustfree place. **Reason :** Dust and damp may adversely affect the working parts in the oven.

- ✎ This microwave oven is not intended for commercial use.

- ✎ The Light bulb should not be replaced in person for safety reasons. Please contact nearest authorised Samsung customer care, to arrange for a qualified engineer to replace the bulb.









⚠ WARNING		🔥	⚡	🚰	👤
✎	Only qualified staff should be allowed to modify or repair the appliance.	✓	✓	✓	✓
✎	Do not heat liquids and other food in sealed containers for microwave function.	✓	✓	✓	✓
✎	For your safety, do not use high-pressure water cleaners or steam jet cleaners.	✓	✓	✓	✓
✎	Do not install this appliance; near heater, inflammable material; in a humid, oily or dusty location, in a location exposed to direct sunlight and water or where gas may leak; on un level ground.	✓	✓	✓	✓
🔌	This appliance must be properly grounded in accordance with local and national codes.	✓	✓	✓	✓





<input checked="" type="checkbox"/>	Remove all foreign substances such as dust or water from the power plug terminals and contact points using a dry cloth on a regular basis.	✓	✓	✓	✓
<input type="checkbox"/>	Do not pull or excessively bend or place heavy object on the power cord.	✓	✓	✓	✓
<input checked="" type="checkbox"/>	In the event of a gas leak (such as propane gas, LP gas, etc.), ventilate immediately without touching the power plug.	✓	✓	✓	✓
<input type="checkbox"/>	Do not touch the power plug with wet hands.	✓	✓	✓	✓
<input type="checkbox"/>	Do not turn the appliance off by unplugging the power plug while an operation is in progress.	✓	✓	✓	✓
<input type="checkbox"/>	Do not insert fingers or foreign substances. If any foreign substance such as water has entered the appliance, unplug the power plug and contact your nearest service centre.	✓	✓	✓	✓
<input type="checkbox"/>	Do not apply excessive pressure or impact to the appliance.	✓	✓	✓	✓
<input type="checkbox"/>	Do not place the oven over a fragile object such as a sink or glass object.	✓	✓		
<input type="checkbox"/>	Do not use benzene, thinner, alcohol, steam cleaner or high pressure cleaner to clean the appliance.	✓	✓	✓	✓
<input type="checkbox"/>	Ensure that the power voltage, frequency and current are the same as those of the product specifications.	✓	✓		✓
<input type="checkbox"/>	Plug the power plug into the wall socket firmly. Do not use a multiple plug adapter, an extension cord or an electric transformer.	✓	✓	✓	
<input type="checkbox"/>	Do not hook the power cord on a metal object, insert the power cord between the objects or behind the oven.	✓	✓	✓	

<input type="checkbox"/>	Do not use a damaged power plug, damaged power cord or loose wall socket. When the power plug or power cord is damaged, contact your nearest service centre.	✓	✓	✓	✓
<input type="checkbox"/>	Do not pour or directly spray water onto the oven.	✓	✓		
<input type="checkbox"/>	Do not place objects on the oven, inside or on the door of the oven.	✓	✓	✓	
<input type="checkbox"/>	Do not spray volatile material such as insecticide onto the surface of the oven.	✓	✓		
<input type="checkbox"/>	Do not store flammable materials in the oven. Take special care when heating dishes or drinks that contain alcohol as alcohol vapours may contact a hot part of the oven.	✓		✓	✓
<input checked="" type="checkbox"/>	Keep children away from the door when opening or closing it as they may bump themselves on the door or catch their fingers in the door.	✓	✓	✓	✓
<input checked="" type="checkbox"/>	WARNING: Microwave heating of beverages can result in delayed eruptive boiling, therefore care must be taken when handling the container; To prevent this situation ALWAYS allow a standing time of at least 20 seconds after the oven has been switched off so that the temperature can equalize. Stir during heating, if necessary, and ALWAYS stir after heating. In the event of scalding, follow these FIRST AID instructions: <ul style="list-style-type: none"> Immerse the scalded area in cold water for at least 10 minutes. Cover with a clean, dry dressing. Do not apply any creams, oils or lotions. 	✓	✓	✓	✓
<input type="checkbox"/>	Do not put the tray or rack in water shortly after cooking because it may cause breakage or damage of the tray or rack.				✓

	Do not operate the microwave oven for deep fat frying because the oil temperature cannot be controlled. This could result in a sudden boil over of the hot liquid.	✓			✓
-----------------------------------------------------------------------------------	--------------------------------------------------------------------------------------------------------------------------------------------------------------------	---	--	--	---

⚠ CAUTION					
------------------	--	-----------------------------------------------------------------------------------	-----------------------------------------------------------------------------------	-----------------------------------------------------------------------------------	-----------------------------------------------------------------------------------

	Only use utensils that are suitable for use in microwave ovens; DO NOT use any metallic containers, Dinnerware with gold or silver trimmings, Skewers, forks, etc. Remove wire twist ties from paper or plastic bags. Reason: Electric arcing or sparking may occur and may damage the oven.	✓		✓	✓
	Do not use your microwave oven to dry papers or clothes.	✓		✓	✓
	Use shorter times for smaller amounts of food to prevent overheating and burning food.	✓		✓	✓
	Do not immerse the power cable or power plug in water and keep the power cable away from heat.	✓	✓		
	Eggs in their shell and whole hard-boiled eggs should not be heated in microwave ovens since they may explode, even after microwave heating has ended; Also do not heat airtight or vacuum-sealed bottles, jars, containers, nuts in shells, tomatoes etc.			✓	✓
	Do not cover the ventilation slots with cloth or paper. They may catch fire as hot air escapes from the oven. The oven may also overheat and switch itself off automatically, and will remain off until it cools sufficiently.	✓		✓	
	Always use oven mitts when removing a dish from the oven to avoid unintentional burns.			✓	
	Stir liquids halfway during heating or after heating ends and allow the liquid stand at least 20 seconds after heating to prevent eruptive boiling.			✓	

	Stand at arms length from the oven when opening the door to avoid getting scalded by escaping hot air or steam.				✓
	Do not operate the microwave oven when it is empty. The microwave oven will automatically shut down for 30 minutes for safety purposes. We recommend placing a glass of water inside the oven at all times to absorb microwave energy in case the microwave oven is started accidentally.	✓			✓
	Install the oven in compliance with the clearances stated in this manual. (See installing your microwave oven.)	✓		✓	
	Take care when connecting other electrical appliances to sockets near the oven.	✓	✓	✓	

PRECAUTIONS TO AVOID POSSIBLE EXPOSURE TO EXCESSIVE MICROWAVE ENERGY. (MICROWAVE FUNCTION ONLY)

Failure to observe the following safety precautions may result in harmful exposure to microwave energy.

- (a) Under no circumstances should any attempt be made to operate the oven with the door open or to tamper with the safety interlocks (door latches) or to insert anything into the safety interlock holes.
- (b) Do NOT place any object between the oven door and front face or allow food or cleaner residues to accumulate on sealing surfaces. Ensure that the door and door sealing surfaces are kept clean by wiping after use first with a damp cloth and then with a soft dry cloth.
- (c) Do NOT operate the oven if it is damaged until it has been repaired by a qualified microwave service technician trained by the manufacturer. It is particularly important that the oven door closes properly and that there is no damage to the:
 - (1) door (bent)
 - (2) door hinges (broken or loose)
 - (3) door seals and sealing surfaces
- (d) The oven should not be adjusted or repaired by anyone other than a properly qualified microwave service technician trained by the manufacturer.

Samsung will charge a repair fee for replacing an accessory or repairing a cosmetic defect if the damage to the unit and/or damage to or loss of the accessory was caused by the customer. Items this stipulation covers include:

- (a) A Dented, Scratched, or Broken Door, Handle, Out-Panel, or Control Panel.
- (b) A Broken or missing Tray, Guide Roller, Coupler, or Wire Rack.
- Use this appliance only for its intended purpose as described in this instruction manual. Warnings and Important Safety Instructions in this manual do not cover all possible conditions and situations that may occur. It is your responsibility to use common sense, caution, and care when installing, maintaining, and operating your appliance.
- Because these following operating instructions cover various models, the characteristics of your microwave oven may differ slightly from those described in this manual and not all warning signs may be applicable. If you have any questions or concerns, contact your nearest service centre or find help and information online at www.samsung.com.
- This microwave oven is supposed for heating food. It is intended for domestic home-use only. Do not heat any type of textiles or cushions filled with grains, which could cause burns and fire. The manufacturer cannot be held liable for damage caused by improper or incorrect use of the appliance.
- Failure to maintain the oven in a clean condition could lead to deterioration of the surface that could adversely affect the life of the appliance and possible result in a hazardous situation.



CORRECT DISPOSAL OF THIS PRODUCT (WASTE ELECTRICAL & ELECTRONIC EQUIPMENT)

(Applicable in countries with separate collection systems)

This marking on the product, accessories or literature indicates that the product and its electronic accessories (e.g. charger, headset, USB cable) should not be disposed of with other household waste at the end of their working life. To prevent possible harm to the environment or human health from uncontrolled waste disposal, please separate these items from other types of waste and recycle them responsibly to promote the sustainable reuse of material resources.

Household users should contact either the retailer where they purchased this product, or their local government office, for details of where and how they can take these items for environmentally safe recycling.

Business users should contact their supplier and check the terms and conditions of the purchase contract. This product and its electronic accessories should not be mixed with other commercial wastes for disposal.

oven features

OVEN (ME81KR*-1, ME81KR*-2, ME81KR*-3)

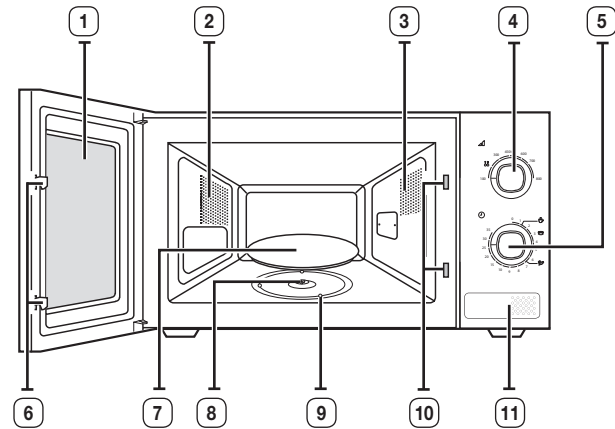

- | | |
|----------------------------------------|----------------------------|
| 1. DOOR | 7. TURNTABLE |
| 2. VENTILATION HOLES | 8. COUPLER |
| 3. LIGHT | 9. ROLLER RING |
| 4. VARIABLE COOKING POWER CONTROL KNOB | 10. SAFETY INTERLOCK HOLES |
| 5. TIMER KNOB | 11. OPEN DOOR PUSH BUTTON |
| 6. DOOR LATCHES | |

OVEN (ME81MR**)

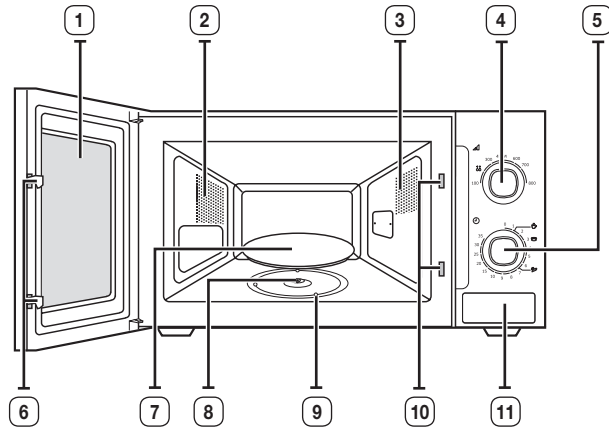

- | | |
|-------------------------------------------|----------------------------|
| 1. DOOR | 7. TURNTABLE |
| 2. VENTILATION HOLES | 8. COUPLER |
| 3. LIGHT | 9. ROLLER RING |
| 4. VARIABLE COOKING POWER
CONTROL KNOB | 10. SAFETY INTERLOCK HOLES |
| 5. TIMER KNOB | 11. OPEN DOOR PUSH BUTTON |
| 6. DOOR LATCHES | |

OVEN (ME81AR*)

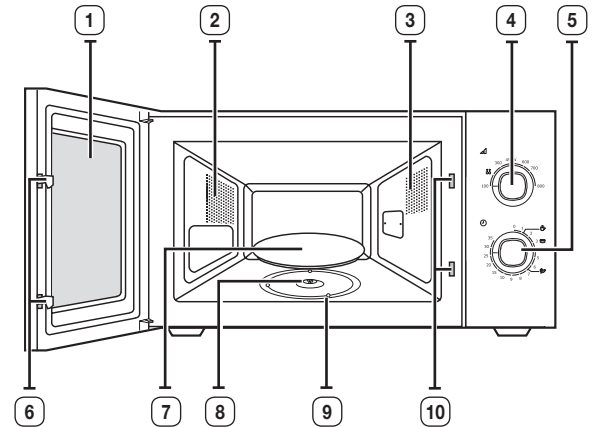

- | | |
|-------------------------------------------|----------------------------|
| 1. DOOR | 6. DOOR LATCHES |
| 2. VENTILATION HOLES | 7. TURNTABLE |
| 3. LIGHT | 8. COUPLER |
| 4. VARIABLE COOKING POWER
CONTROL KNOB | 9. ROLLER RING |
| 5. TIMER KNOB | 10. SAFETY INTERLOCK HOLES |

CONTROL PANEL (ME81KR*-1, ME81KR*-2, ME81KR*-3)

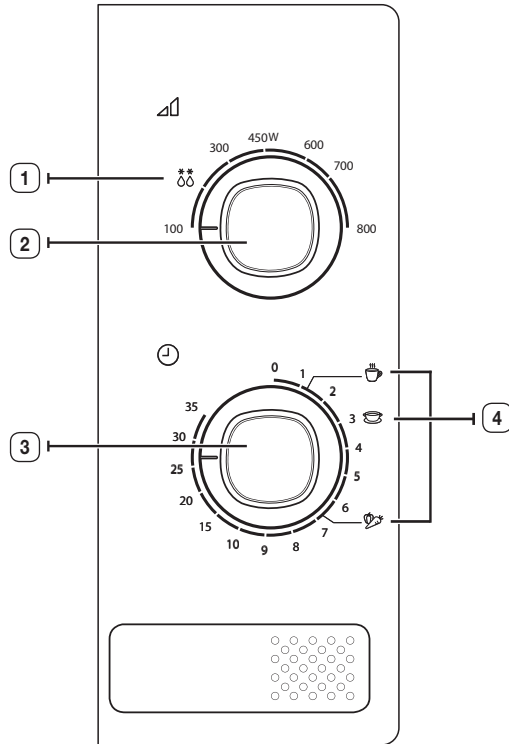

1. DEFROST
2. VARIABLE COOKING POWER CONTROL KNOB
3. TIMER KNOB
4. INSTANT REHEAT

CONTROL PANEL (ME81MR**)

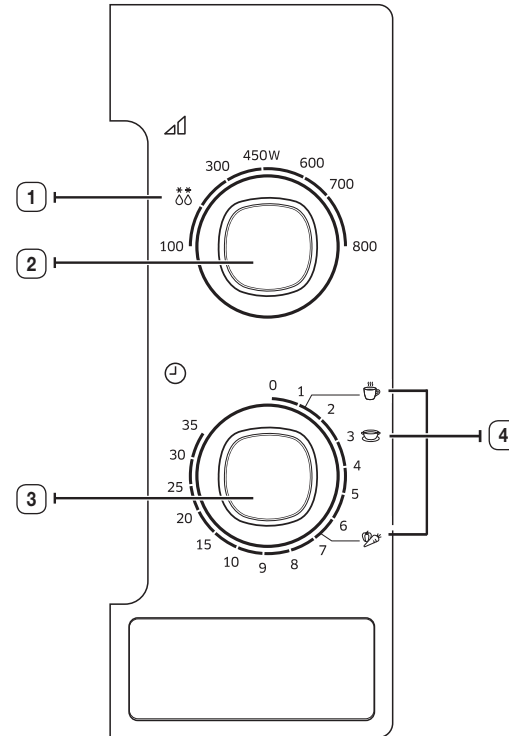

1. DEFROST
2. VARIABLE COOKING POWER CONTROL KNOB
3. TIMER KNOB
4. INSTANT REHEAT

CONTROL PANEL (ME81AR*)

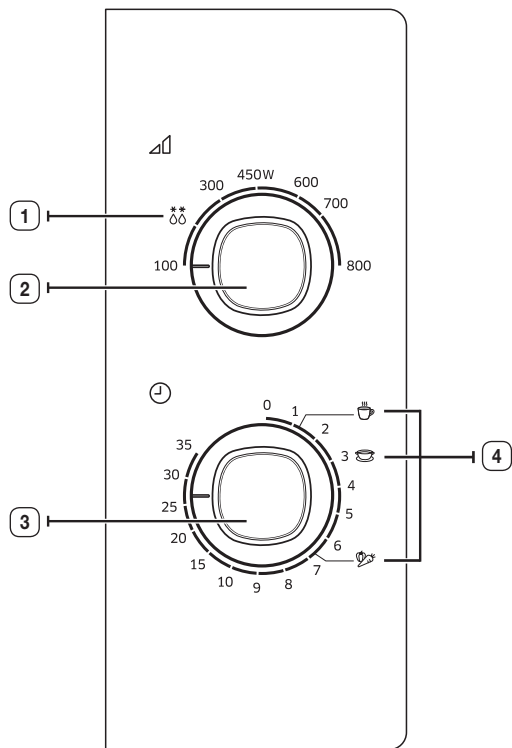

1. DEFROST
2. VARIABLE COOKING POWER CONTROL KNOB
3. TIMER KNOB
4. INSTANT REHEAT

ACCESSORIES

Depending on the model that you have purchased, you are supplied with several accessories that can be used in a variety of ways.

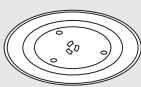
	1. Roller ring , to be placed in the centre of the oven. Purpose: The roller ring supports the turntable.
	2. Turntable , to be placed on the roller ring with the centre fitting to the coupler. Purpose: The turntable serves as the main cooking surface; it can be easily removed for cleaning.

 **DO NOT** operate the microwave oven without the roller ring and turntable.

oven use

COOKING/REHEATING

The following procedure explains how to cook or reheat food. ALWAYS check your cooking settings before leaving the oven unattended.

First, place the food in the centre of the turntable and close the door.

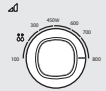
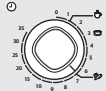
	<ol style="list-style-type: none"> Set the power level to maximum by turning COOKING POWER CONTROL knob. (MAXIMUM POWER : 800 W)
	<ol style="list-style-type: none"> Set the time by turning TIMER knob. Result: The oven light comes on and the turntable starts rotating.

 **Never** switch the microwave oven on when it is empty.

 You can change the power level during cooking by turning the **COOKING POWER CONTROL** knob.

POWER LEVELS

You can choose among the power levels below.

Power level	Output
HIGH	800 W
REHEAT	700 W
MEDIUM HIGH	600 W
MEDIUM	450 W
MEDIUM LOW	300 W
DEFROST	180 W
LOW	100 W

 If you select higher power level, the cooking time must be decreased.

 If you select lower power level, the cooking time must be increased.

STOPPING THE COOKING

You can stop cooking at any time to check the food.

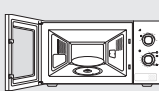
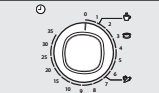
	<ol style="list-style-type: none"> To stop temporarily; Open the door. Result: Cooking stops. To resume cooking, close the door.
	<ol style="list-style-type: none"> To stop completely; Turn the TIMER knob to "0".

ADJUSTING THE COOKING TIME

Adjust the remaining cooking time by rotating the **TIMER** knob.

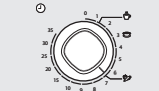
	<ul style="list-style-type: none"> Just turning TIMER Knob to adjust cooking time.
------------------------------------------------------------------------------------	----------------------------------------------------------------------------------------------------------

MANUAL DEFROSTING FOOD

The Defrost feature enables you to defrost meat, poultry, fish.

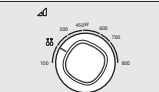
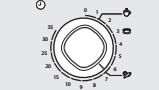

First, place the frozen food in the centre of the turntable and close the door.

	<ol style="list-style-type: none"> Turn the COOKING POWER CONTROL knob to the Defrost symbol.
	<ol style="list-style-type: none"> Turn the TIMER knob to select the appropriate time. Result: Defrosting begins.

 Use only recipients that are microwave-safe.

USING THE INSTANT REHEAT FEATURE



First, place the food in the center of the turntable and close the door.

	<p>1. Turn the COOKING POWER CONTROL knob to Max Power.</p>
	<p>2. Turn the TIMER knob to select Instant Reheat. (drinks or soup/sauce, fresh vegetables).</p>

 Use only recipients that are microwave-safe.

INSTANT REHEAT SETTINGS

Here are a few tips and recommendations to be followed when cooking or reheating food with the Instant Reheat and Cooking Feature.

Food	Serving Size	Cooking time	Standing time
Drinks 	150 ml	1 min. 10 sec.	1-2 min.
Soup/Sauce (chilled) 	200-250 g	3 min.	2-3 min.
Fresh vegetables 	150 ml (1 cup) 250 ml (1 mug)	6 min. 40 sec.	2-3 min.

cookware guide

To cook food in the microwave oven, the microwaves must be able to penetrate the food, without being reflected or absorbed by the dish used.

Care must therefore be taken when choosing the cookware. If the cookware is marked microwave-safe, you do not need to worry.

The following table lists various types of cookware and indicates whether and how they should be used in a microwave oven.

Cookware	Microwave-safe	Comments
Aluminum foil	✓ X	Can be used in small quantities to protect areas against overcooking. Arcing can occur if the foil is too close to the oven wall or if too much foil is used.
Browning plate	✓	Do not preheat for more than eight minutes.
China and earthenware	✓	Porcelain, pottery, glazed earthenware and bone china are usually suitable, unless decorated with a metal trim.
Disposable polyester cardboard dishes	✓	Some frozen foods are packaged in these dishes.
Fast-food packaging		
<ul style="list-style-type: none"> Polystyrene cups containers 	✓	Can be used to warm food. Overheating may cause the polystyrene to melt.
<ul style="list-style-type: none"> Paper bags or newspaper 	X	May catch fire.
<ul style="list-style-type: none"> Recycled paper or metal trims 	X	May cause arcing.

Cookware	Microwave-safe	Comments
Glassware		
• Oven-to-table ware	✓	Can be used, unless decorated with a metal trim.
• Fine glassware	✓	Can be used to warm foods or liquids. Delicate glass may break or crack if heated suddenly.
• Glass jars	✓	Must remove the lid. Suitable for warming only.
Metal		
• Dishes	✗	May cause arcing or fire.
• Freezer bag twist ties	✗	
Paper		
• Plates, cups, napkins and kitchen paper	✓	For short cooking times and warming. Also to absorb excess moisture.
• Recycled paper	✗	May cause arcing.
Plastic		
• Containers	✓	Particularly if heat-resistant thermoplastic. Some other plastics may warp or discolour at high temperatures. Do not use melamine plastic.
• Cling film	✓	Can be used to retain moisture. Should not touch the food. Take care when removing the film as hot steam will escape.
• Freezer bags	✓ ✗	Only if boilable or oven-proof. Should not be airtight. Prick with a fork, if necessary.
Wax or grease-proof paper	✓	Can be used to retain moisture and prevent spattering.

✓ : Recommended

✓ ✗ : Use Caution

✗ : Unsafe

troubleshooting

If you have any of the problems listed below try the solutions given.

This is normal.

- Condensation inside the oven.
- Air flow around the door and outer casing.
- Light reflection around the door and outer casing.
- Steam escaping from around the door or vents.

The oven does not start when you turn the TIMER knob.

- Is the door completely closed?

The food is not cooked at all.

- Have you set the timer correctly?
- Is the door closed?
- Have you overloaded the electric circuit and caused a fuse to blow or a breaker to be triggered?

The food is either overcooked or undercooked.

- Was the appropriate cooking length set for the type of food?
- Was an appropriate power level chosen?

The light bulb is not working.

- The light bulb should not be replaced in person for safety reasons. Please contact nearest authorised Samsung customer care, to arrange for a qualified engineer to replace the bulb.

The oven causes interference with radios or televisions.

- Slight interference may be observed on televisions or radios when the oven is operating. This is normal. To solve this problem, install the oven away from televisions, radios and aerials.

Sparking and cracking occur inside the oven (arcng).

- Have you used a dish with metal trimmings?
- Have you left a fork or other metal utensil inside the oven?
- Is aluminum foil too close to the inside walls?

Smoke and bad smell when initial operating.

- It's a temporary condition by new component heating. Smoke and smell will disappear completely after 10 minutes operation.
To remove smell more quickly, please operate microwave oven with putting lemon formation or lemon juice in the cabinet.

 If the above guidelines do not enable you to solve the problem, then contact your local SAMSUNG customer service centre.

Please have the following information read;

- The model and serial numbers, normally printed on the rear of the oven
- Your warranty details
- A clear description of the problem

Then contact your local dealer or SAMSUNG aftersales service.

Подлежит использованию по назначению
в нормальных условиях
Срок службы: 7 лет



Символ «не для пищевой продукции» применяется в соответствии с техническим регламентом Таможенного союза «О безопасности упаковки» 005/2011 и указывает на то, что упаковка данного продукта не предназначена для повторного использования и подлежит утилизации. Упаковку данного продукта запрещается использовать для хранения пищевой продукции.



Символ «петля Мебиуса» указывает на возможность утилизации упаковки. Символ может быть дополнен обозначением материала упаковки в виде цифрового и/или буквенного обозначения.

technical specifications

SAMSUNG strives to improve its products at all times. Both the design specifications and these user instructions are thus subject to change without notice.

Model	ME81KR*-1, ME81KR*-2, ME81KR*-3, ME81MR**, ME81AR*
Power source	230 V ~ 50 Hz
Power consumption Microwave	1150 W
Output power	100 W / 800 W (IEC-705)
Operating frequency	2450 MHz
Magnetron	OM75S (31)
Cooling method	Cooling fan motor
Dimensions (W x H x D) Outside	489 x 275 x 364 mm (ME81KR*-1) 489 x 275 x 360 mm (ME81KR*-2) 489 x 275 x 369 mm (ME81KR*-3) 489 x 275 x 359 mm (ME81MR**) 489 x 275 x 364 mm (ME81AR*)
Oven cavity	330 x 211 x 324 mm
Volume	23 liter
Weight Net	11.5 kg approx (ME81KR*-1, ME81KR*-2, ME81KR*-3, ME81AR*) 12.0 kg approx (ME81MR**)

※ оборудование класса I

MEMO

MEMO



Производитель : Samsung Electronics Co., Ltd /
Самсунг Электроникс Ко., Лтд

Адрес производителя :
(Мэтан-донг) 129, Самсунг-ро, Йонгтонг-гу, Сувон-си,
Йонгги-до, Корея, 443-742

Адрес мощностей производства :
ЛОТ 2, ЛЕБУХ 2, НОРС КЛАНГ СТРЕЙТС, ЭРИА 21,
ИНДАСТРИАЛ ПАРК, 42000
ПОРТ КЛАНГ, СЕЛАНГОР ДАРУЛ ЭСАН, МАЛАЙЗИЯ

Страна производства : Малайзия

Импортер в России :
ООО «Самсунг Электроникс Рус Компани»
Адрес: 125009, г. Москва, Россия, ул. Воздвиженка 10, 4 этаж

В СЛУЧАЕ ВОЗНИКНОВЕНИЯ ВОПРОСОВ ИЛИ КОММЕНТАРИЕВ

СТРАНА	ТЕЛЕФОН	ВЕБ-УЗЕЛ
RUSSIA	8-800-555-55-55	www.samsung.com/ru/support
GEORGIA	0-800-555-555	www.samsung.com/support
ARMENIA	0-800-05-555	
AZERBAIJAN	0-88-555-55-55	
KAZAKHSTAN	8-10-800-500-55-500(GSM: 7799, VIP care 7700)	
UZBEKISTAN	8-10-800-500-55-500	
KYRGYZSTAN	8-10-800-500-55-500	www.samsung.com/kz_ru/support
TADJIKISTAN	8-10-800-500-55-500	www.samsung.com/support
MONGOLIA	7-495-363-17-00	
BELARUS	810-800-500-55-500	
MOLDOVA	0-800-614-40	
UKRAINE	0-800-502-000	www.samsung.com/ua/support (Ukrainian) www.samsung.com/ua_ru/support (Russian)

DE68-04286A-01