



05819 - 379A

# LEVEL 3

1 2 3 4 5



THE  
NATIONAL  
MUSEUM



HMS Victory® is a registered trade mark and is used under license by Revell GmbH.  
Profits from the sale of this product go towards the preservation of Naval heritage.

# HMS VICTORY

Beiliegenden Sicherheitstext beachten / Please note the enclosed safety advice

- Ⓒ Beiliegenden Sicherheitstext beachten und nachschlagbereit halten.
- Ⓓ Please note the enclosed safety advice and keep safe for later reference.
- Ⓔ Respecter les consignes de sécurité ci-jointes et les conserver à portée de main.
- Ⓕ Houdt u aan de bijgaande veiligheidsinstructies en hou deze steeds bij de hand.
- Ⓖ Seguire le avvertenze di sicurezza allegate e tenerle a portata di mano.
- Ⓗ Observar y siempre tener a disposición este texto de seguridad adjunto.
- Ⓟ Ter em atenção o texto de segurança anexo e guardá-lo para consulta.
- Ⓒ Overhold vedlagte sikkerhedsanvisninger og hav dem liggende i nærheden.
- Ⓝ Ha alltid vedlagt sikkerhetstekst klar til bruk.
- Ⓔ Beakta bifogad säkerhetstext och håll den i beredskap.
- Ⓕ Huomioi ja säilytä oheiset varoitukset.
- Ⓓ Соблюдать технику безопасности, сохранить инструкцию для дальнейших обращений.
- Ⓖ Przestrzegać załączonego tekstu dotyczącego bezpieczeństwa i mieć go zawsze pod ręką.
- Ⓒ Dodržujte tento priložený bezpečnostní text a mějte ho po ruce.
- Ⓗ A mellékelt biztonsági szöveget vegye figyelembe és tartsa fellepozásra készen.
- Ⓒ Respektujte priložený bezpečnostný text a uchovajte ho pre budúce použitie.
- Ⓓ Respectați textul de siguranță atașat și păstrați-l la îndemână.
- Ⓔ Спазвайте приложения текст за безопасност и го дръжте под ръка за справки.
- Ⓓ Priložena varnostna navodila izvajajte in jih hranite na vsem dostopnem mestu.
- Ⓖ Λάβετε υπόψη σας το συννημένο κείμενο ασφαλείας και φυλάξτε το ώστε να ανατρέχετε σε αυτό όποτε χρειάζεται.
- Ⓓ Ektekiqüvenlik talimatlarını dikkate alıp, bakabileceğiniz bir şekilde muafaza ediniz.

© 2016 Revell GmbH, Henschelstr. 20-30, D-32257 Bünde. A subsidiary of Hobbico, Inc.  
REVELL IS THE REGISTERED TRADEMARK OF REVELL GMBH, GERMANY. [www.revell.de](http://www.revell.de)



☞ Weitere Tipps und Tricks.  
 ☞ Additional tips and tricks.  
 ☞ Conseils et astuces supplémentaires.  
 ☞ Andere tips en trucs.  
 ☞ Ulteriori consigli e suggerimenti.  
 ☞ Consejos y sugerencias adicionales.  
 ☞ Mais dicas e truques.

☞ Flere tips og tricks.  
 ☞ Flere tips og tricks.  
 ☞ Ytterligare tips och tricks.  
 ☞ Lisää vinkkejä ja niksejä.  
 ☞ Другие советы и хитрости.  
 ☞ Dalsze wskazówki i sugestie.  
 ☞ Další tipy a rady.  
 ☞ További ötletek és fogások.  
 ☞ Dalsie tipy a triky.  
 ☞ Alte sfaturi și trucuri.

☞ Други полезни съвети и трикове.  
 ☞ Nadaljnji nasveti in zvižaje.  
 ☞ Πρόσθετες συμβουλές και κόλπα.  
 ☞ Diğer öneriler ve ipuçları.

www.revell.de



- DE Kleben
- GB Glue
- FR Collier
- NL Lijmen
- IT Incollare
- ES Pegamento
- PT Colar
- DK Lim
- NO Lime
- SE Limma
- FI Liimaa
- RU Kleить
- PL Przykleić
- CZ Slepění
- HU Ragasztás rá
- SK Lepiť
- NO Lipiti
- BG Залепете
- SI Prilepite
- GR Κολλήστε
- TR Yapıştırma



- DE Bemalen
- GB Paint
- FR Peindre
- NL Beschilderen
- IT Colorare
- ES Pintar
- PT Pintar
- DK Mal
- NO Male
- SE Måla
- FI Maalaa
- RU Раскрасить
- PL Pomalować
- CZ Pomalovat
- HU Fesse be
- SK Natrieť
- NO Vopsiñ
- BG Боядисайте
- SI Pobarvajite
- GR Βάψτε
- TR Boyama



- DE Abbildung zusammengesetzter Teile.
- GB Illustration of assembled parts.
- FR Figure représentant les pièces assemblées.
- NL Afbeelding van samengevoegde onderdelen.
- IT Foto delle parti assemblate.
- ES Figura de las piezas montadas.
- PT Ilustração das peças montadas.
- DK Illustration af samlede dele.
- NO Figur av sammensatte deler.
- SE Bild på sammansatta detaljer.
- FI Kootujen osien kuva.
- RU Изображение смонтированных деталей.
- PL Rysunek połączonych części.
- CZ Zobrazení spojených dílů.
- HU Összerakott alkatrészek ábrája.
- SK Obrázok dielov, ktoré sa majú zmontovať.
- NO Figura representând piesele asamblate.
- BG Изображение наглобените части.
- SI Slika sestavljenih delov.
- GR Απεικόνιση των τοποθετημένων μερών.
- TR Birleştirilmiş parçalar resmi.



- DE Bauteile trocknen lassen.
- GB Allow the parts to dry.
- FR Laisser sécher les pièces.
- NL Onderdelen laten drogen.
- IT Lasciare asciugare i componenti.
- ES Dejar secar las piezas.
- PT Deixar as peças secar.
- DK Lad delene tørre.
- NO Tørk komponenter.
- SE Låt komponenterna torka.
- FI Anna rakenneosien kuivua.
- RU Дайте деталям высохнуть.
- PL Pozostawić elementy konstrukcji do wyschnięcia.
- CZ Nechte díly uschnout.
- HU Hagyj megszáradni az alkatrészeket.
- NO Konstruksjonle delene nechte utdørre.
- BG Оставете компонентите да изсъхнат.
- SI Osušite sestavne dele.
- GR Αφήστε τα μέρη να στεγνώσουν.
- TR Yapı parçalarını kurumaya bırakın.



- DE Mit Klebeband fixieren.
- GB Attach with adhesive tape.
- FR Fixer à l'aide de ruban adhésif.
- NL Met plakband vastzetten.
- IT Fissare con nastro adesivo.
- ES Fijar con cinta adhesiva.
- PT Fixar com fita adesiva.
- DK Fastgør med tape.
- NO Fest med tape.
- SE Fixera med tejp.
- FI Kiinnittää liimanauhalla.
- RU Зафиксировать липкой лентой.
- PL Przy mocować za pomocą taśmy samoprzylepnej.
- CZ Připevněte lepicí páskou.
- HU Rögzítse ragasztószalaggal.
- SK Fixujte lepiacou páskou.
- NO Fixați cu bandă adezivă.
- BG Фиксирайте с тиксо.
- SI Prilodite z lepilnim trakom.
- GR Στερεώστε με κολλητική ταινία.
- TR Yapıştırma bandi ile sabitleyin.



- DE Flaggen ausschneiden, in der Mitte falzen und am Faden zusammenkleben.
- GB Cut out flags, fold in the middle and stick together at thread.
- FR Découper les pavillons, plier dans le milieu et coller au niveau du fil.
- NL Vlaggen uitknippen, in het midden vouwen en op de draad aan elkaar lijmen.
- IT Ritagliare le bandiere, piegarle in mezzo e incollarle assieme sul filo.
- ES Cortar las pestañas, doblar por la mitad y pegar a la altura del hilo.
- PT Cortar a bandeira, dobrar a meio e colar no fio.
- DK Klip flagene ud, fold dem på midten og lim dem sammen om tråden.
- NO Skjær ut flaggene, brett i midten og lim sammen ved tråden.
- SE Klipp ut flaggorna, vik de i mitten och limma ihop de runt tråden.
- FI Leikkaa liput irti, taita keskeltä ja liimaa langan ympärille.
- RU Вырезать флаги, сложить посередине и приклеить на нить.
- PL Wyciąć flagi, złożyć pośrodku i przykleić je do nitki.
- CZ Vystrihněte praporky, uprostřed je přeložte a slepte je na niti.
- HU Vágjon ki zászlókat, középen hajtsa be és a fonálon ragasztásra össe.
- NO Vystrihnite vlajky, v stred ich ohnite a spolu ich na nitke zlepte.
- BG Decupați steagurile, îndoțiți-le la mijloc și lipiți-le de fir.
- BG Изрежете флаговете, сгънете ги в средата и ги залепете на конеца.
- SI Izrezite zastavo in jo upognite na sredini in na robovih zlepte skupraj.
- GR Κόψτε τις σημαίες, διπλώστε στη μέση και κολλήστε στην κλωστή.
- TR Bayrakları kesin, ortadan katlayın ve ipliğe yapıştırın.



- DE Abziehbild in Wasser einweichen und anbringen.
- GB Soak and apply decals.
- FR Mouiller et appliquer les décalcomanies.
- NL Transfer in water even laten weken en aanbrengen.
- IT Immergere la decalcomania nell'acqua e applicarla.
- ES Mojar y aplicar calcomanías.
- PT Amolecer o decalque em água e aplicar.
- DK Gör overføringsbilledet vådt og sæt det på.
- NO Myk opp avtrekkingsbildet i vann og sett på.
- SE Blötlägg dekalen i vatten och sätt på den.
- FI Pehmitä siirtokuva vedessä ja siirrä raikalleen.
- RU Опустите переводную картинку в воду и нанесите её.
- PL Namoczyc kalkomanie w wodzie i przykleic.
- CZ Nechte obtisk odmočit ve vodě a přilepte.
- HU Merítse vízbe és helyezze fel a matricát.
- NO Obtlačkový obrázok namočte do vody a priložte na plochu.
- NO Inmuaiați abțibildul în apă și aplicați-l.
- BG Потопете ваденката във вода и я поставете.
- SI Prelepnico namakajte v vodi. In namestite.
- GR Μουσκεψτε σε νερό και τοποθετήστε τις χαλκομανίες.
- TR Çikartmayı suda yumuşatın ve takın.



- DE Zur Anbringung der Abziehbilder empfohlen.
- GB Recommended for affixing the decals.
- FR Recommandé pour l'application des décalcomanies.
- NL Aanbevolen voor het aanbrengen van de transfers.
- IT Raccomandato per l'applicazione delle decalcomanie.
- ES Recomendado para fijar bien las calcomanías.
- PT Recomendado para a fixação dos autocolantes.
- DK Anbefales til anbringelse af overføringsbillederne.
- NO Anbefales til å feste avtrekkingsbilder.
- SE Rekommenderad för montering av klisterdekalerna.
- FI Suositellaan siirtokuvien siirtämiseen.
- RU Рекомендуется для нанесения переводных картинок.
- PL Zalecane do przyklejenia kalkomanii.
- CZ Doporučujeme k umístění obtiskovacích obrázků.
- HU A matrica felhelyezéséhez ajánljuk.
- NO Odporuča sa pre umiestnenie obtlačkového obrázku.
- NO Recomandat pentru aplicarea abțibildurilor.
- BG Препоръчва се за поставяне на ваденки.
- SI Pri nameščanju nalepnice priporočamo.
- GR Συνιστάται για την τοποθέτηση των χαλκομανιών.
- TR Çikartmaların takılması için önerilir.



- DE Nicht enthalten
- GB Not included
- FR Non fourni
- NL Behoort niet tot de levering
- IT Non incluso
- ES No incluido
- PT Não incluído
- DK Medfølger ikke
- NO Ikke inkludert
- SE Ingår ej
- FI Ei sisällä
- RU Не содержится
- PL Nie wchodzi w zakres dostawy
- CZ Není obsaženo
- HU Nem tartalmazza
- NO Neobsahuje
- NO Nu este inclus
- BG Не се включва в комплекта
- SI Ni priloženo
- GR Δεν περιλαμβάνεται
- TR İçermiyor

## Benötigte Farben / Required colours

FR Peintures nécessaires  
NL Benodigde kleuren  
IT Colori necessari  
ES Colores necesarios  
PT Cores necessárias  
DK Nødvendige farver  
NO Nødvendige farger  
SE Erforderliga färger  
FI Tarvittavat värit  
RU Необходимые краски  
PL Potrzebne kolory  
CZ Potřebné barvy  
HU Szükséges színek  
SK Požadované farby  
RO Colori necesare  
BG Необходими цветове  
SI Potrebne barve  
GR Απαιτούμενα χρώματα  
TR Gerekli renkler

93

A

DE Kupfer metallic  
GB Copper metallic  
FR Cuivre métallique  
NL Koper metallic  
IT Rame metallico  
ES Cobre metálico  
PT Cobre metálico  
DK Kobber metallisk  
NO Kobber metallisk  
SE Koppar metallisk  
FI Kupari metallinen  
RU Медь металлический  
PL Miedziany metaliczny  
CZ Měděná metalizový  
HU Vörösréz metál  
SK Medená metaliza  
RO Cupru metallic  
BG Мед металик  
SI Baker kovinska  
GR Χάλκινο μεταλλικό  
TR Bakır rengi metalik

09

B

DE Anthrazit matt  
GB Anthracite matt  
FR Anthracite mat  
NL Antraciet mat  
IT Antracite opaco  
ES Antracita mate  
PT Antracite mate  
DK Antracitgrå mat  
NO Antrasitt matt  
SE Antracitgrå matt  
FI Antrasiitinharmaa matta  
RU Антрацит матовый  
PL Antracyt matowy  
CZ Antracitová šedá matný  
HU Antracit, fénytelen  
SK Čierna uhľová matný  
RO Antracit mat  
BG Антрацит матово  
SI Antracit mat  
GR Ανθρακί ματ  
TR Antrazit mat

15

C

DE Gelb matt  
GB Yellow matt  
FR Jaune mat  
NL Geel mat  
IT Giallo opaco  
ES Amarillo mate  
PT Amarelo mate  
DK Gul mat  
NO Gul matt  
SE Gul matt  
FI Keltainen matta  
RU Желтый матовый  
PL Żółty matowy  
CZ Žlutá matný  
HU Sárga, fénytelen  
SK Žltá matný  
RO Galben mat  
BG Жълто матово  
SI Rumena mat  
GR Κίτρινο ματ  
TR Sarı mat

314

D

DE Beige seidenmatt  
GB Beige silk matt  
FR Beige satiné mat  
NL Beige zijdemat  
IT Beige opaco satinato  
ES Beige mate satinado  
PT Beige mate sedoso  
DK Beige silkematt  
NO Beige silkematt  
SE Beige sidenmatt  
FI Beige silkkimatta  
RU Бежевый шелковисто-матовый  
PL Beżowy jedwabście matowy  
CZ Běžová jemně matný  
HU Bézs, fakóselymes  
SK Běžová hodvábné matný  
RO Bej satinat  
BG Бежово коприненоматово  
SI Bež svileni-mat  
GR Μπεζ σατινέ  
TR Bej ipeksi mat

302

E

DE Schwarz seidenmatt  
GB Black silk matt  
FR Noir satiné mat  
NL Zwart zijdemat  
IT Nero opaco satinato  
ES Negro mate satinado  
PT Preto mate sedoso  
DK Sort silkematt  
NO Sort silkematt  
SE Svart sidenmatt  
FI Musta silkkimatta  
RU Черный шелковисто-матовый  
PL Czarny jedwabście matowy  
CZ Černá jemně matný  
HU Fekete, fakóselymes  
SK Čierna hodvábné matný  
RO Negru satinat  
BG Черно коприненоматово  
SI Črna svileni-mat  
GR Μαύρο σατινέ  
TR Siyah ipeksi mat

88

F

DE Ocker matt  
GB Ochre matt  
FR Ocre mat  
NL Oker mat  
IT Ocra opaco  
ES Ocre mate  
PT Ocre mate  
DK Okkerbrun mat  
NO Okerbrun matt  
SE Ockrabrun matt  
FI Okranruskea matta  
RU Охра матовый  
PL Ochra matowy  
CZ Okr hnědý matný  
HU Okker, fénytelen  
SK Okrová matný  
RO Ocru mat  
BG Охра матово  
SI Oker mat  
GR Ωχρα ματ  
TR Toprak rengi mat

382

G

DE Holzbraun seidenmatt  
GB Wood brown silk matt  
FR Brun bois satiné mat  
NL Houtbruin zijdemat  
IT Marrone legno opaco satinato  
ES Marrón madera mate satinado  
PT Castanho madeira mate sedoso  
DK Træbrun silkematt  
NO Trebrun silkematt  
SE Träbrun sidenmatt  
FI Puunruskea silkkimatta  
RU Древесно-коричневый шелковисто-матовый  
PL Brązowy w odcieniu drewna jedwabście matowy  
CZ Dřevěná hnědá jemně matný  
HU Fa barna, fakóselymes  
SK Drevená hnedá hodvábné matný  
RO Maro lemnos satinat  
BG Дървеснокафяво коприненоматово  
SI Lesno-rjava svileni-mat  
GR Καφέ ανοιχτό σατινέ  
TR Ahşap rengi ipeksi mat

301

H

DE Weiß seidenmatt  
GB White silk matt  
FR Blanc satiné mat  
NL Wit zijdemat  
IT Bianco opaco satinato  
ES Blanco mate satinado  
PT Branco mate sedoso  
DK Hvid silkematt  
NO Hvit silkematt  
SE Vit sidenmatt  
FI Valkoinen silkkimatta  
RU Белый шелковисто-матовый  
PL Biały jedwabście matowy  
CZ Bílá jemně matný  
HU Fehér, fakóselymes  
SK Biela hodvábné matný  
RO Alb satinat  
BG Бяло коприненоматово  
SI Bela svileni-mat  
GR Άσπρο σατινέ  
TR Beyaz ipeksi mat

56

I

DE Blau matt  
GB Blue matt  
FR Bleu mat  
NL Blauw mat  
IT Blu opaco  
ES Azul mate  
PT Azul mate  
DK Blå mat  
NO Blå matt  
SE Blå matt  
FI Sininen matta  
RU Синий матовый  
PL Niebieski matowy  
CZ Modrá matný  
HU Kék, fénytelen  
SK Modrá matný  
RO Albastru mat  
BG Синьо матово  
SI Modra mat  
GR Μπλε ματ  
TR Mavi mat

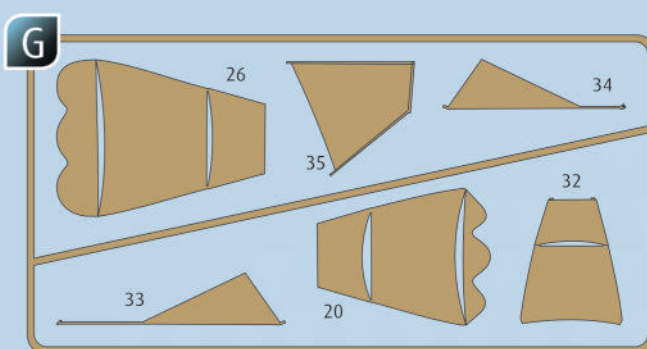
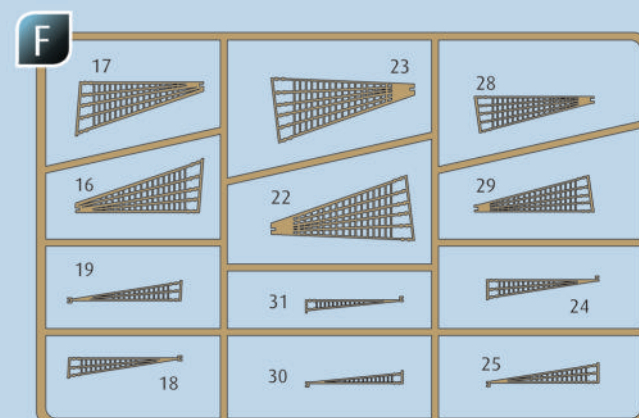
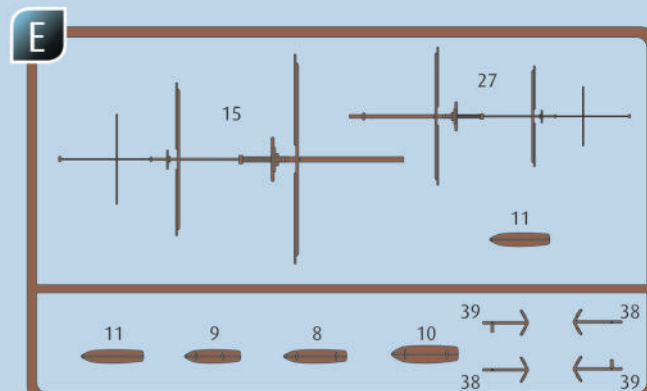
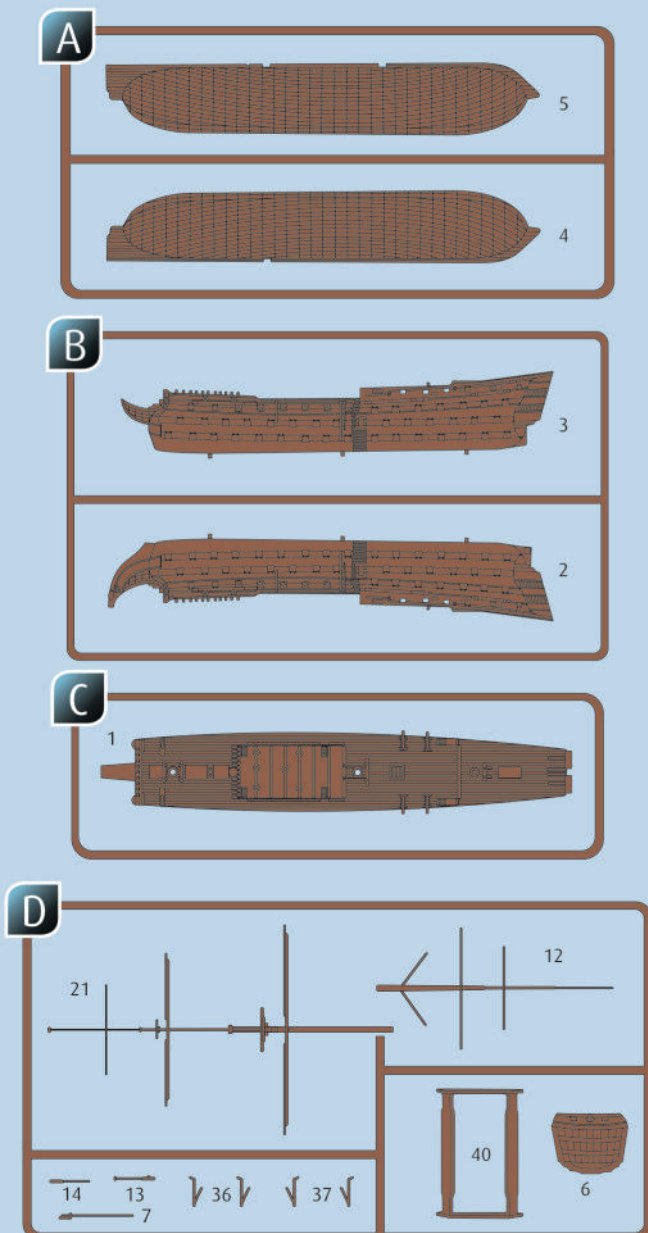

### Ersatzteile benötigt?

Kein Problem. Einfach den Revell-Service mit Angabe von Artikel- und Teilenummer kontaktieren. Entweder unter [service@revell.de](mailto:service@revell.de) oder Revell GmbH, Abteilung X, Henschelstr. 20-30, 32257 Bünde.\*

\*Wir bitten um Verständnis, dass eine Gewährleistung nur bei aktuellen Artikeln, die im Zeitraum der letzten 24 Monate erworben wurden, übernommen werden kann. Mit der Ersatzteil-Bestellung können Kosten z.B. für Verpackung und Versand entstehen. Ob diese Kosten anfallen wird im Vorfeld schriftlich durch unseren Service mitgeteilt. Das Angebot kann dann angenommen oder abgelehnt werden. Unfrei eingesandte Ersatzteil-Bestellungen werden von uns nicht angenommen! Dieser Direktservice gilt für die Länder Deutschland, Benelux, Österreich, Frankreich, Großbritannien. Ersatzteil-Bestellungen aus den übrigen Ländern werden über die jeweiligen Distributeure abgewickelt. Bitte kontaktieren Sie Ihren Händler.

### Besoin de pièces de rechange ?

Il vous suffit de contacter le service Revell et d'indiquer la référence de l'article et de la pièce. Soit en écrivant par mail à [france@revell.de](mailto:france@revell.de) (uniquement pour la France) ou par courrier à Revell GmbH, Département X, Henschelstr. 20-30, D-32257 Bünde.\*

\*La garantie s'applique pour les articles présents au catalogue et achetés au cours des 24 derniers mois. Merci de votre compréhension. La commande de pièces de rechange peut donner lieu à des frais supplémentaires, par ex. pour l'emballage et le port. Notre service client vous en informera au préalable par écrit. Vous pourrez accepter ou refuser le devis. Nous n'acceptons pas les commandes de pièces de rechange envoyées sans affranchissement ! Ce service direct est valable pour les pays suivants : Allemagne, Benelux, Autriche, France, Grande-Bretagne. Les commandes de pièces en provenance d'autres pays sont traitées par les distributeurs correspondants. Veuillez contacter votre revendeur.

### Need spare parts?

No problem. Contact Revell Service with the item number and part numbers you need: [service@revell.de](mailto:service@revell.de) or Revell GmbH, Unit 10, Old Airfield Industrial Estate, Cheddington Lane, Tring, Herts, HP23 4QR, Great Britain.\*

\*We request your understanding that a warranty can only be accepted for current articles which have been purchased in the last 24 months. Orders for spare parts may also be subject to costs for packaging and shipping. You will be notified in advance by our Service department if such costs are incurred. The offer can then be accepted or rejected. We will not be able to process any postal requests unless correct postage has been applied to mailing! This direct service applies to the countries: Germany, Benelux, Austria, France, and the United Kingdom. Spare part orders from other countries are processed by the local distributors. Please contact your dealer.

### Hebt u reserveonderdelen nodig?

Geen probleem! Neem eenvoudig contact op met de klantenservice van Revell en geef ons het artikel- en onderdeelnummer door. U kunt ons bereiken op [service@revell.de](mailto:service@revell.de) of per post: Revell GmbH, Afdeling X, Henschelstr. 20-30, 32257 Bünde.\*

\*Wij vragen uw begrip voor de omstandigheid, dat er alleen garantie kan worden geboden voor actuele artikelen, die in de afgelopen 24 maanden zijn gekocht. Met het bestellen van reserveonderdelen kunnen kosten gemoeid zijn, bijv. voor verpakking en verzending. U wordt vooraf schriftelijk door onze klantenservice op de hoogte gesteld als er kosten zouden ontstaan. Het aanbod kan dan worden aangenomen of afgewezen. Wij nemen geen ongefrankeerde bestellingen van reserveonderdelen aan! Deze rechtstreekse service wordt verleend in de landen Duitsland, de Benelux, Oostenrijk, Frankrijk en Groot-Brittannië. Bestellingen van reserveonderdelen in de overige landen worden afgewikkeld via de betreffende distributeurs. Neem hiervoor contact op met uw verkoper.



1

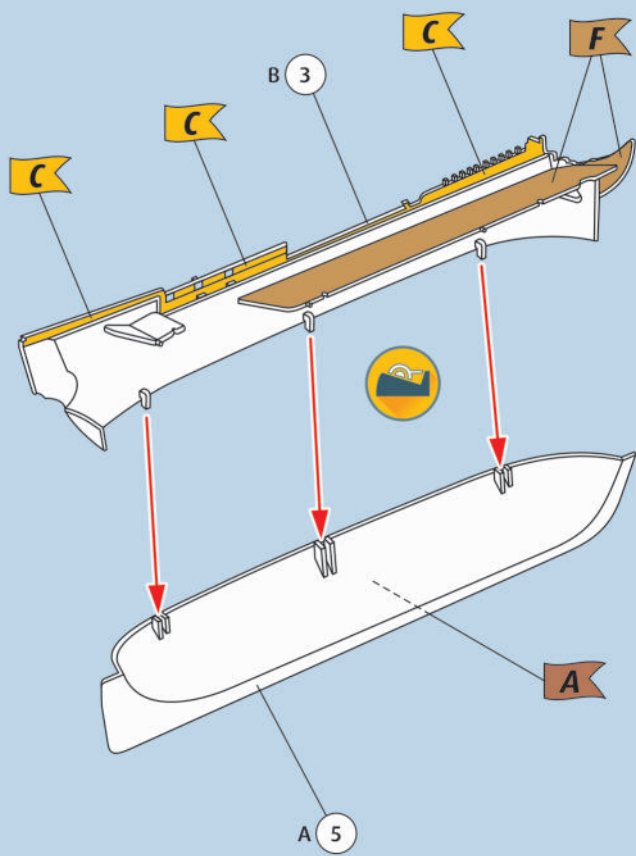

2

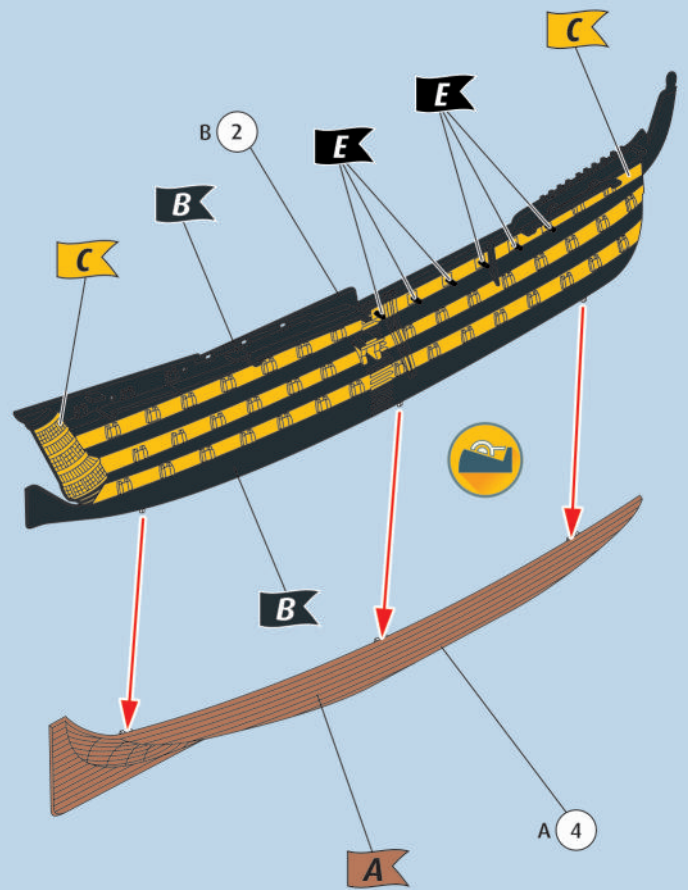

3

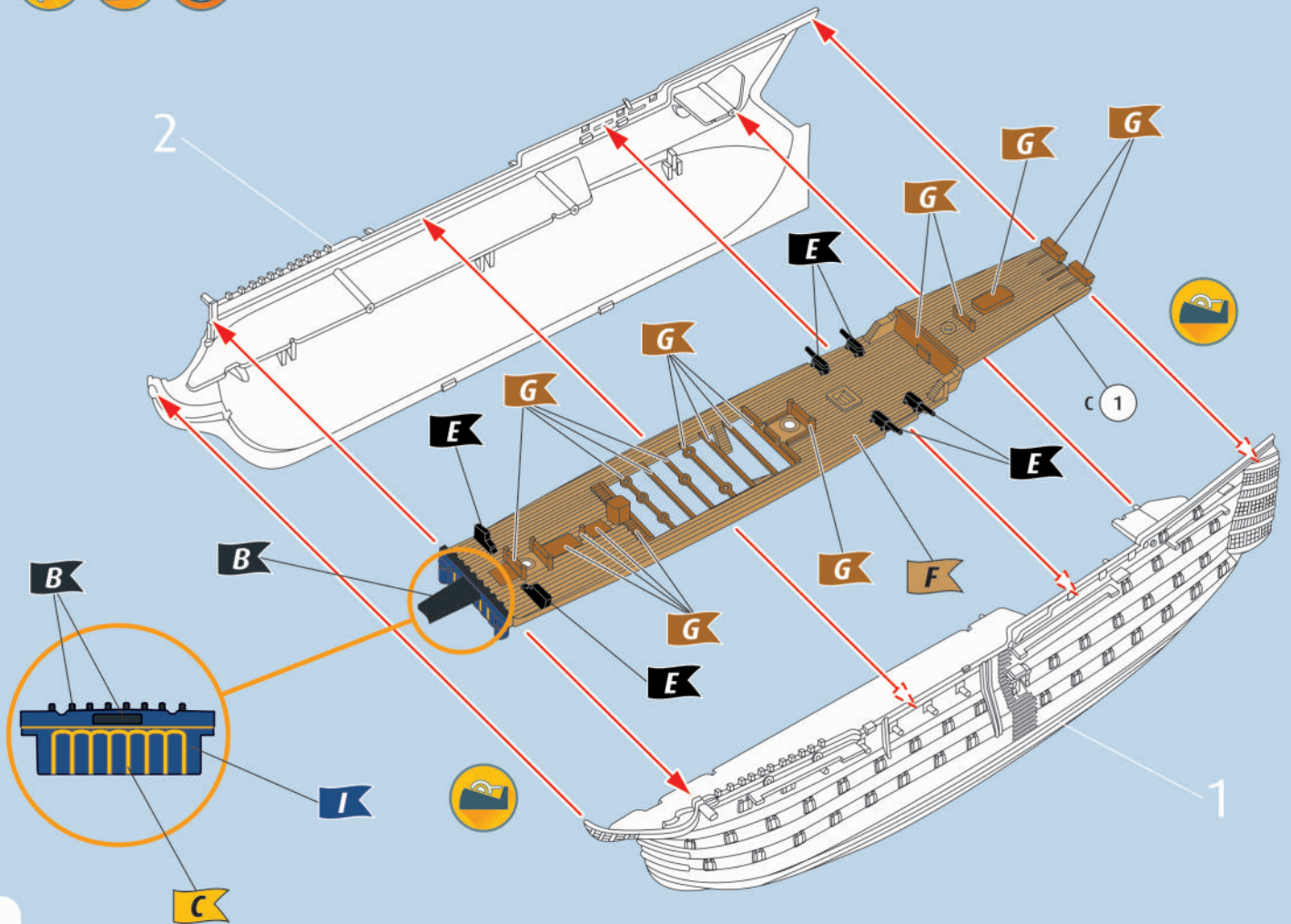

4  

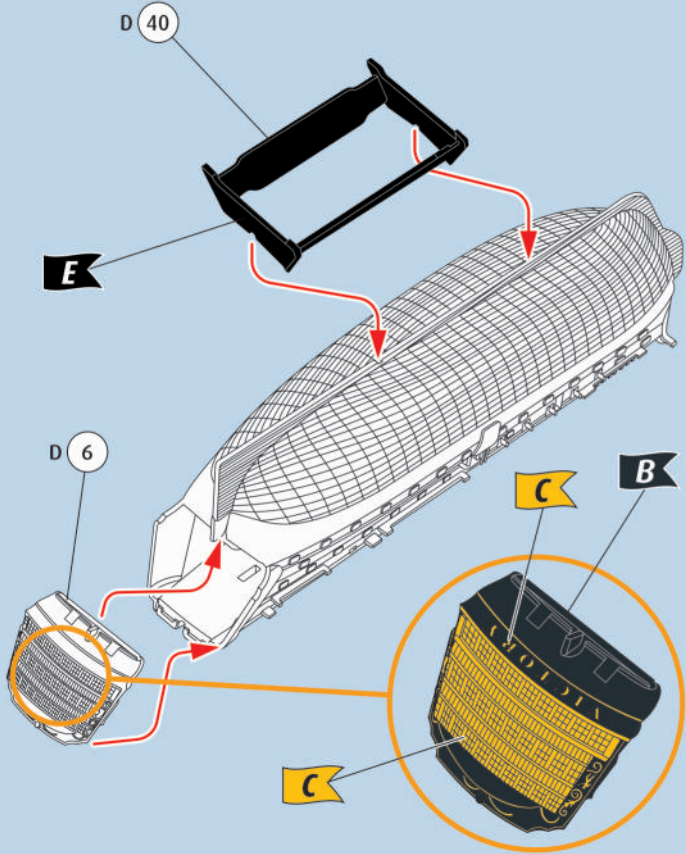

5  

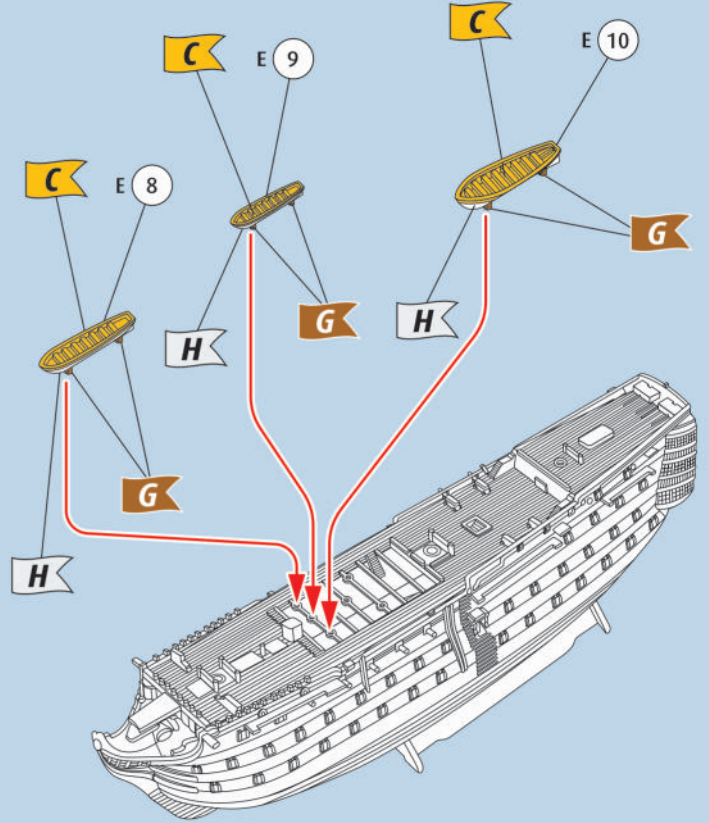

6  

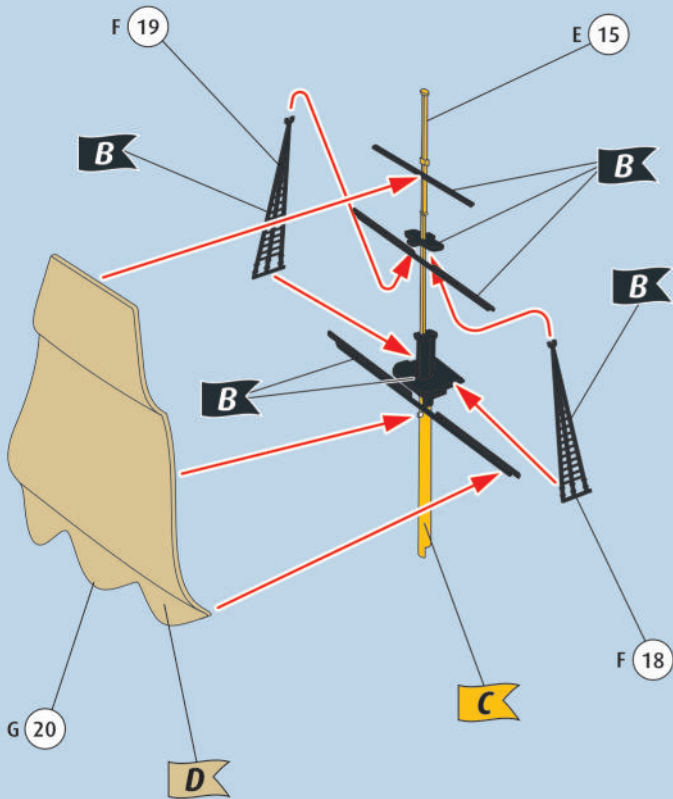

7  

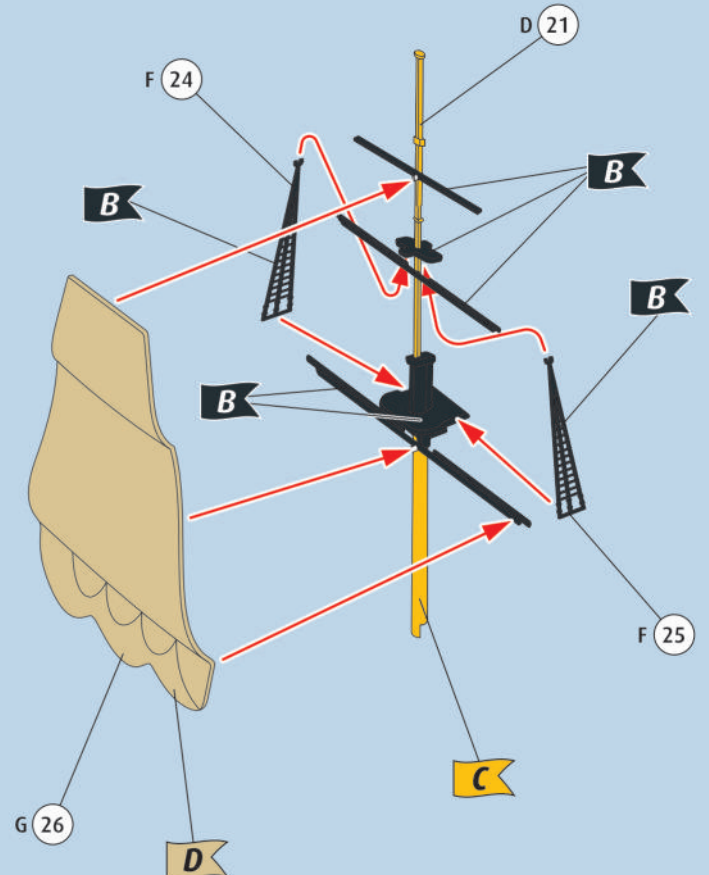

8

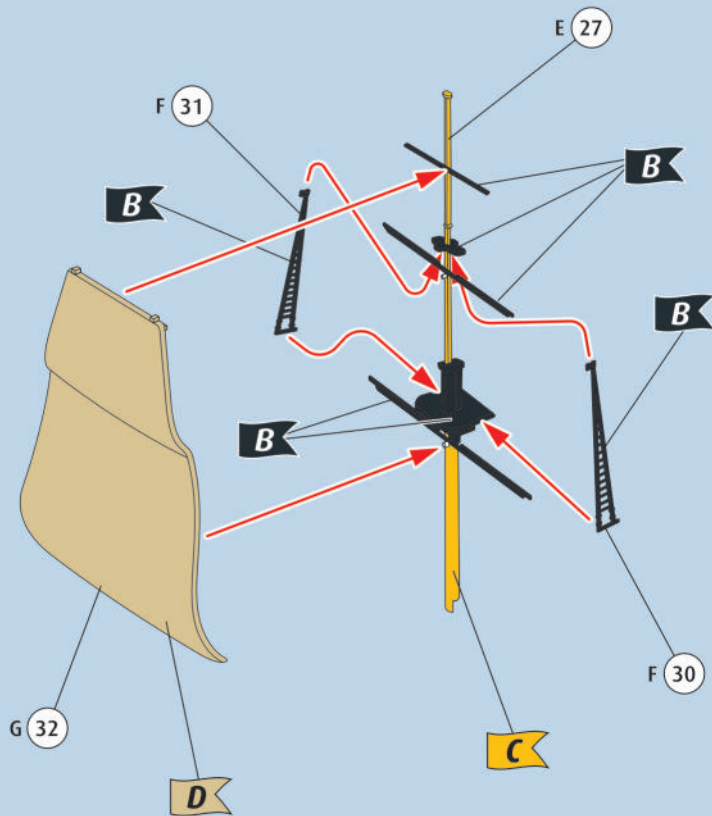

9

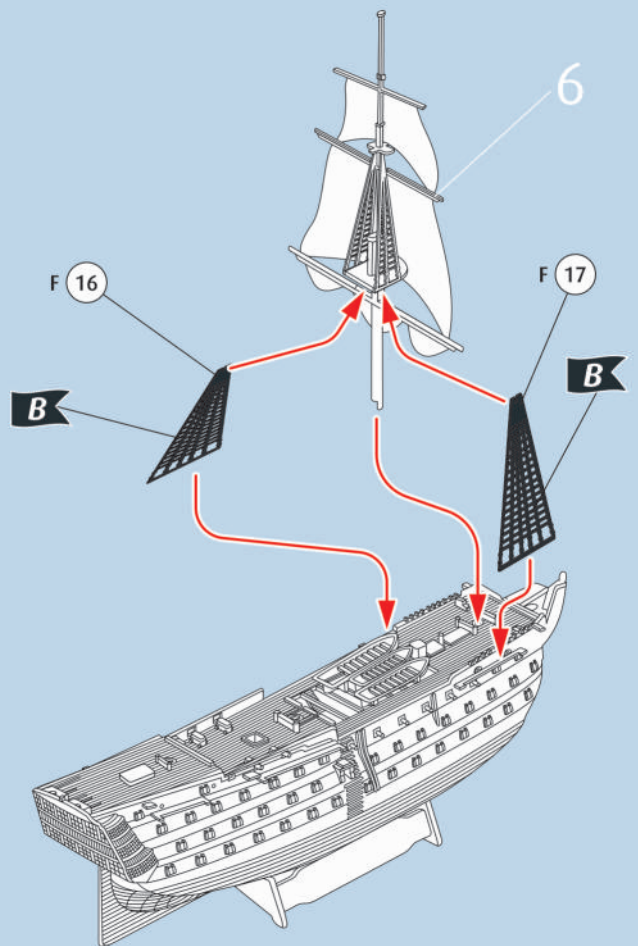

10

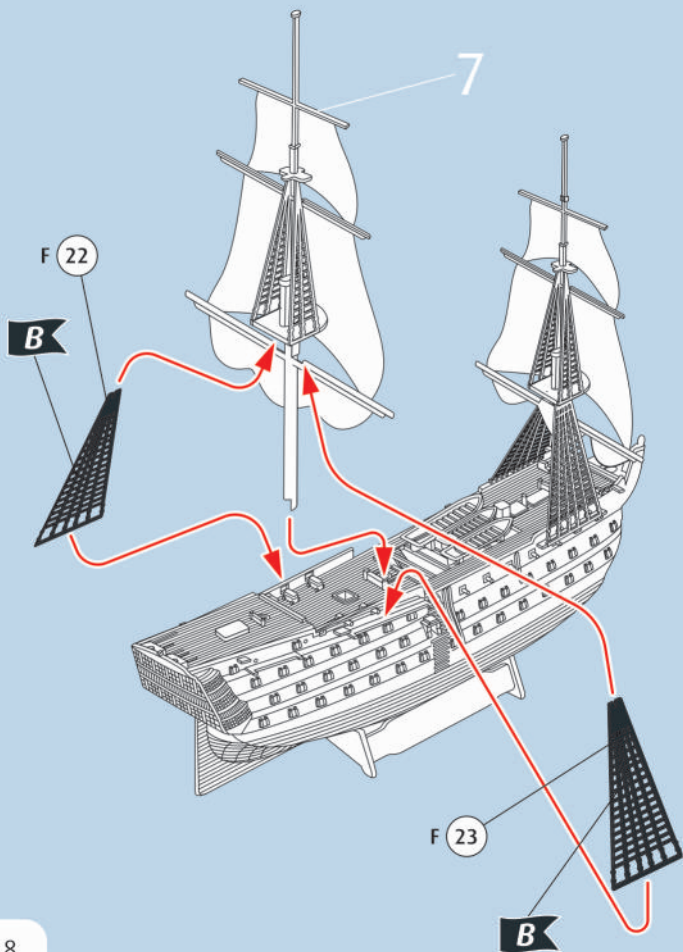

11

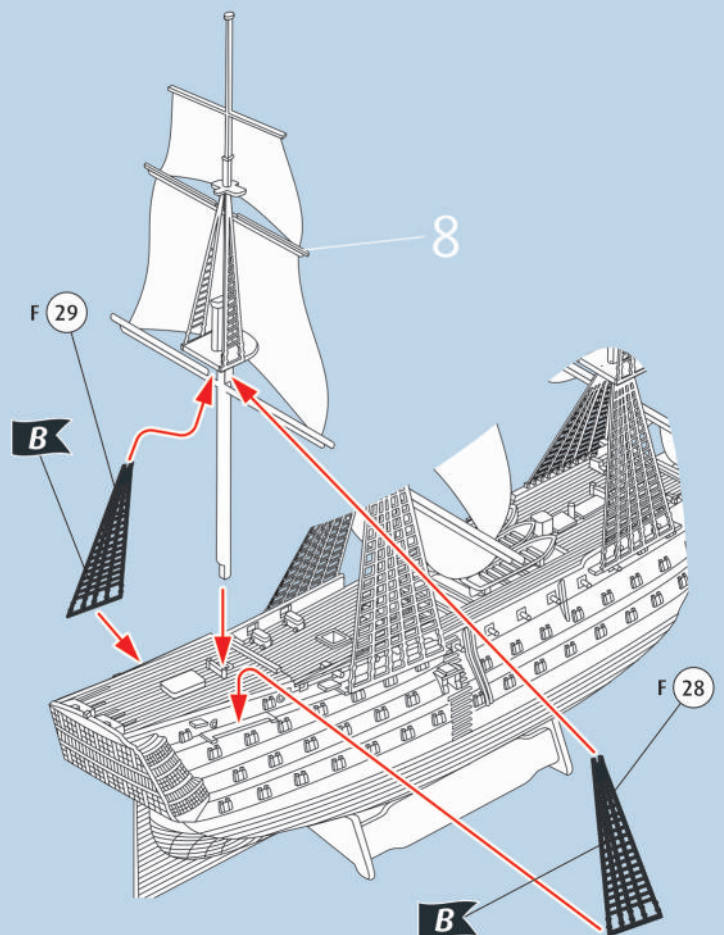



# 12

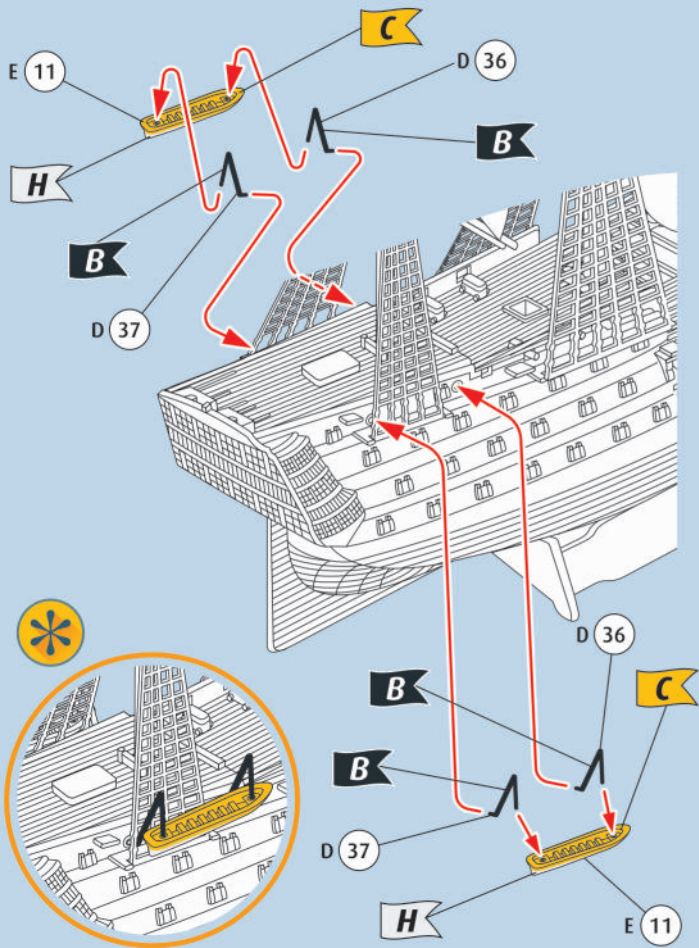

# 13

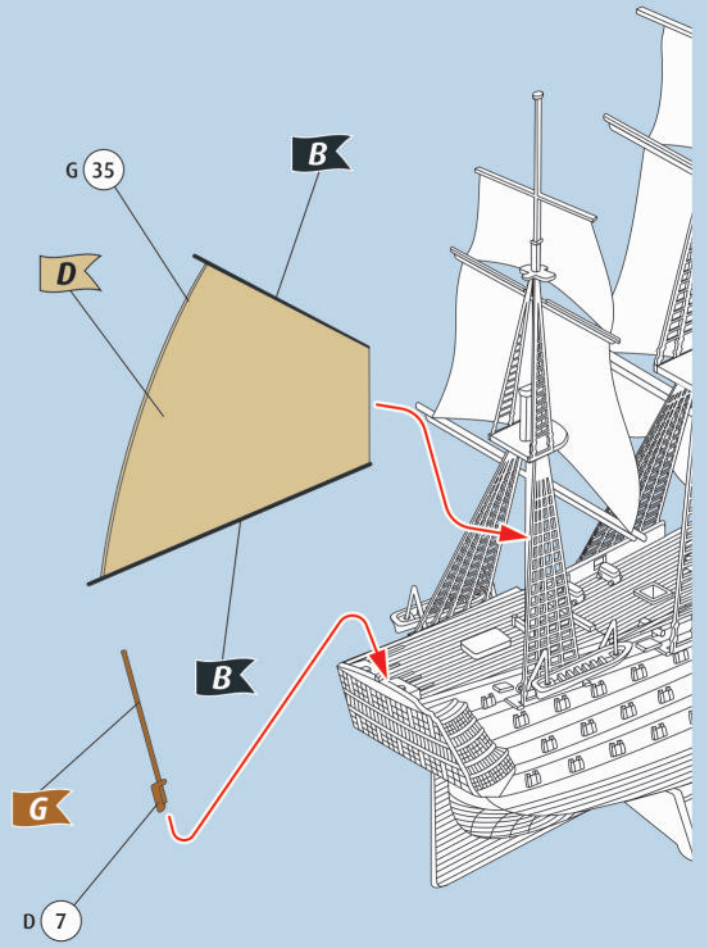

# 14

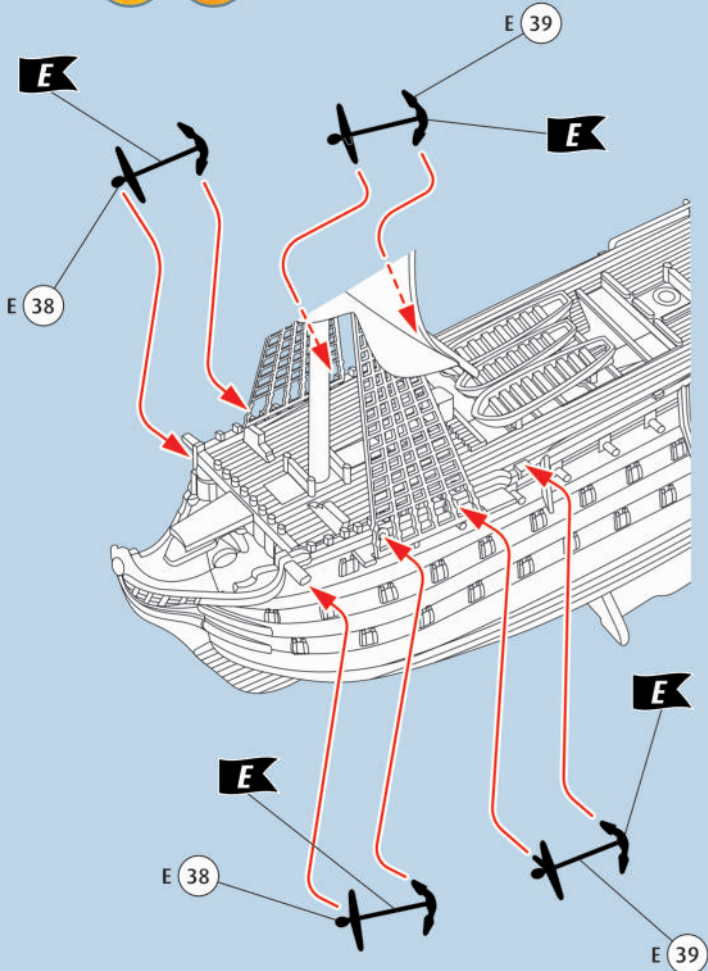

# 15

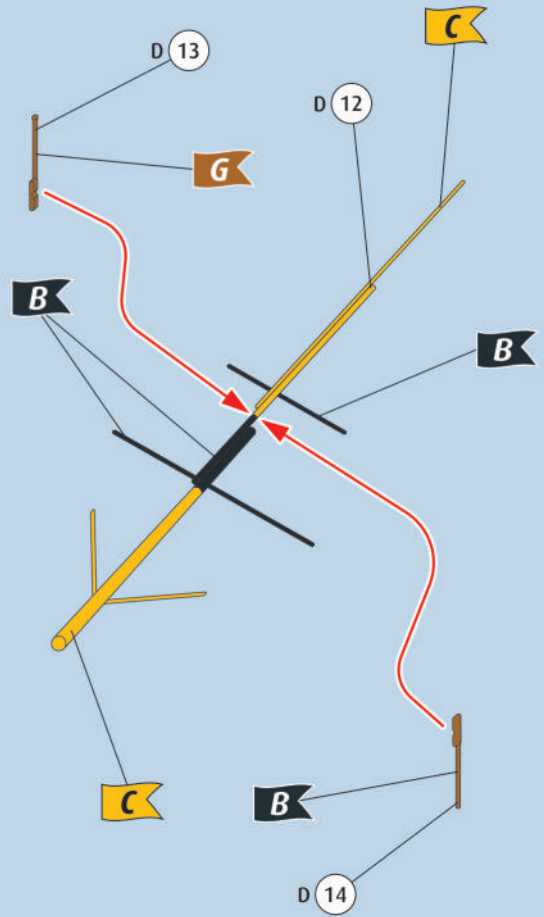

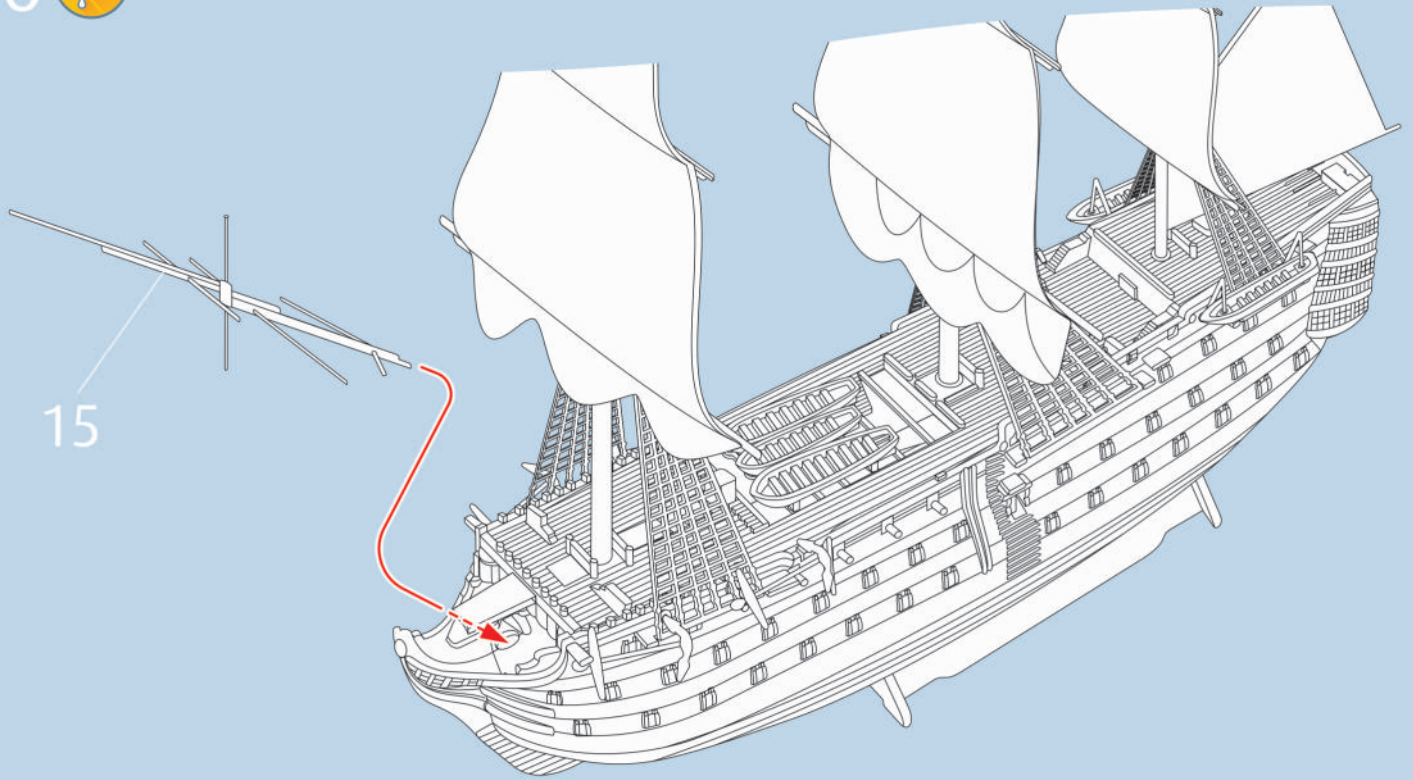
16 17  