



# classic

11040







LEGO® Builder



[LEGO.com/sustainable-packaging](https://LEGO.com/sustainable-packaging)



 <sup>FR</sup> **DONNEZ**  
OU  
**RECYCLEZ**

 OU  OU 

ASSOCIATION MAGASIN DÉCHÈTERIE

Adresses sur [quefairedemesdechets.fr](https://quefairedemesdechets.fr)

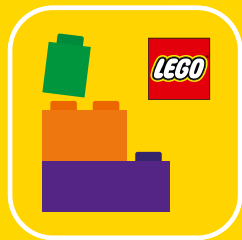

Q LEGO® Builder

# BUILDER



Apple and the Apple logo are trademarks of Apple Inc., registered in the U.S. and other countries and regions. App Store is a service mark of Apple Inc. Google Play and the Google Play logo are trademarks of Google LLC. Tencent and the Tencent logo are trademarks of Tencent Inc.

Q [LEGO.com/devicecheck](https://www.lego.com/devicecheck)

EN Ask parents' permission before going online | DE Eltern um Erlaubnis bitten, bevor du online gehst | FR Demande l'autorisation d'un parent avant d'aller en ligne | IT Chiedi il permesso ai tuoi genitori prima di andare online | ES Pídeles permiso a tus papás antes de conectarte a Internet | PT Pede autorização aos pais antes de acederes online | ZH 上网前应先征得父母的同意 | PL Poproś rodziców o zgodę, zanim wejdiesz do Internetu | CS Než půjdeš na internet, požádej rodiče o svolení | SK Skôr než pôjdeš na internet, vypýtaj si povolenie od rodičov | HU Kérj szülői engedélyt, mielőtt online csatlakoznál! | RO Cere permisiunea părinților înainte de a te conecta online | BG Поискайте разрешение от родител, преди да влезете онлайн | LV Pirms došanās tiešsaistē palūdz atļauju vecākiem | ET Enne Interneti kasutamist küsi vanematelt luba | LT Prieš prisijungdami prie interneto, atsiklauskite tėvų







↪ 23



↪ 34

↪ 28



**ideas**  
included

Ideas included  
Mit Bauideen  
Idées incluses  
Idee incluse  
Incluye ideas  
Ideias incluídas  
内含拼搭创意  
Pomysły w zestawie

Obsahuje tipy na stavění  
Obsahuje tipy na stavanie  
Ötletek a dobozban  
Idei incluse  
Съдържа примерни идеи  
Iekļautas idejas  
Kaasas ideed  
Priedamos idėjos



↪ 42

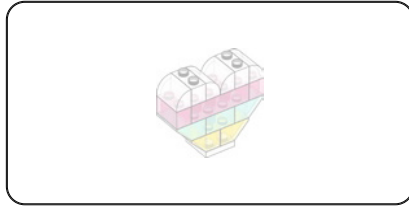

1



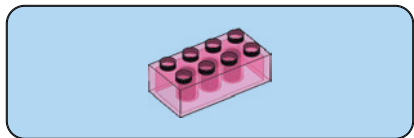

2

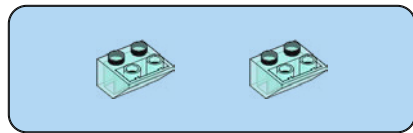

3

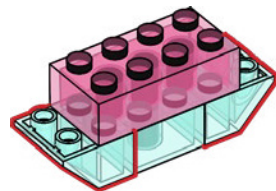

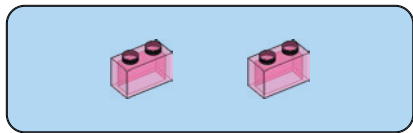

4

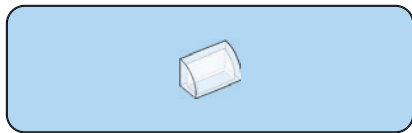
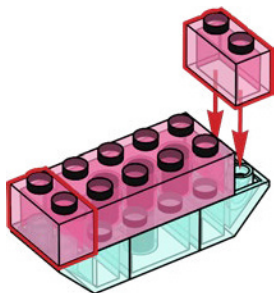

5

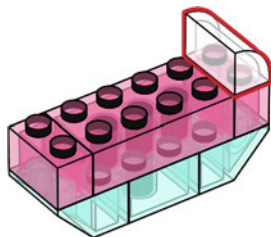

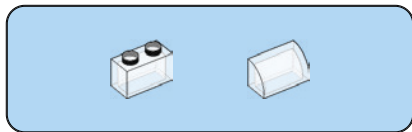

6

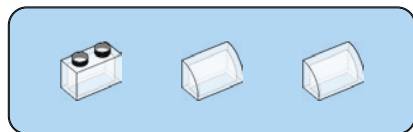
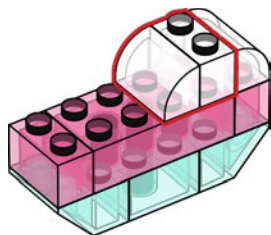

7

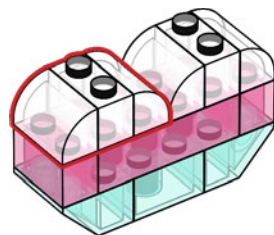



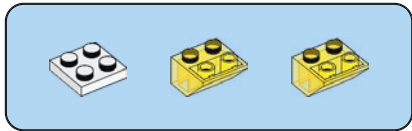

8

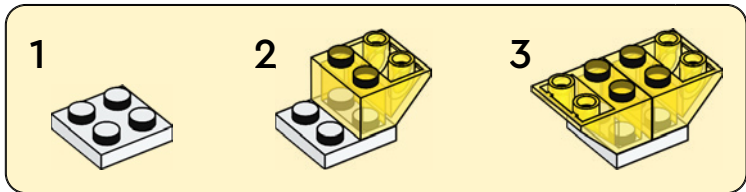
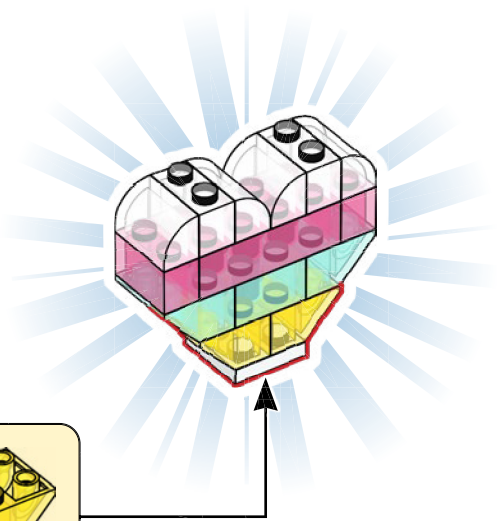

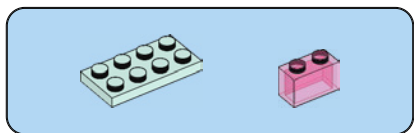
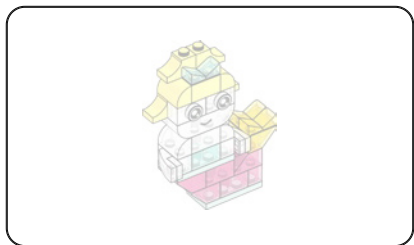

1

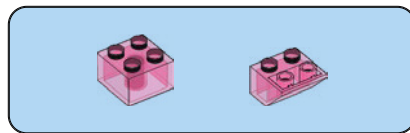
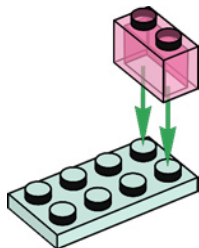

2

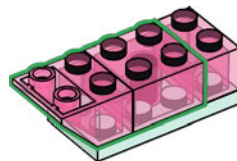



3

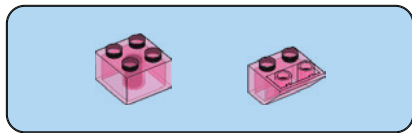
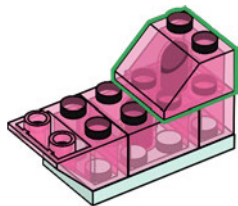

4

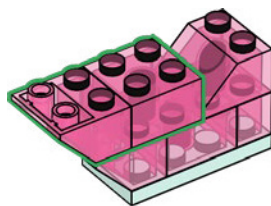

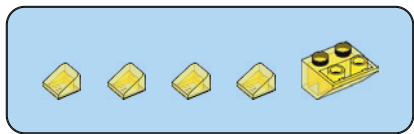

5

1

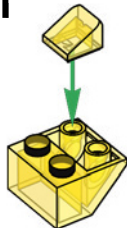

2



3

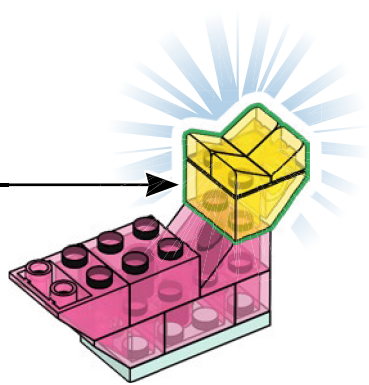

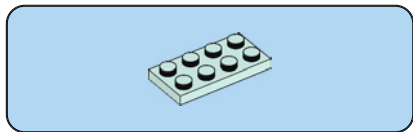

6

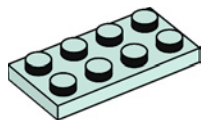

7

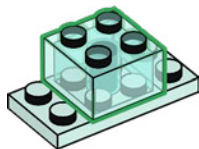



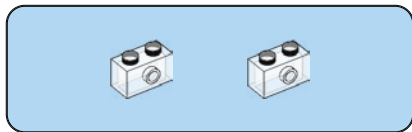

8

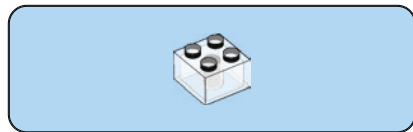
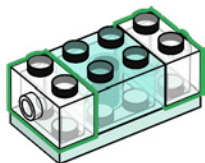

9

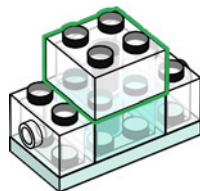

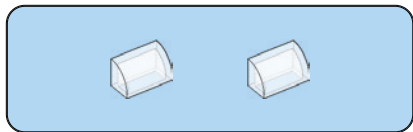

10

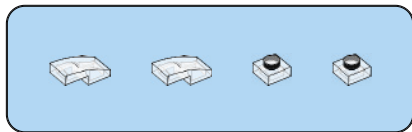

11

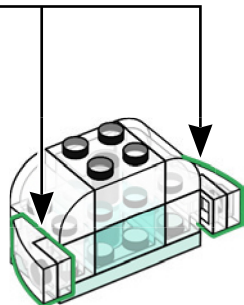
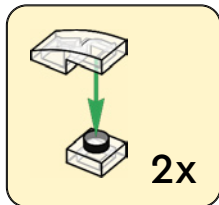

12

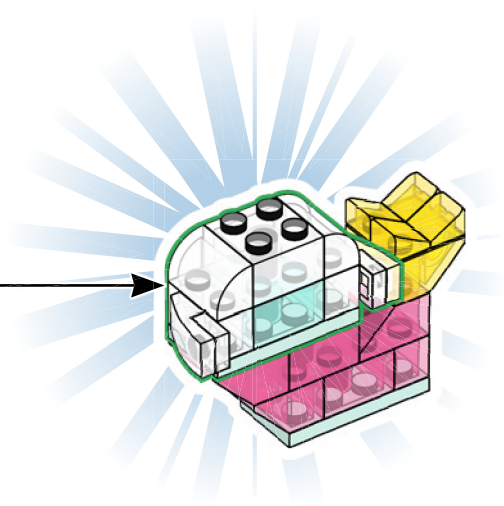

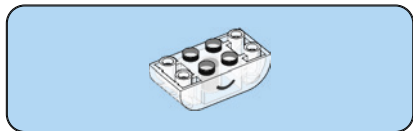
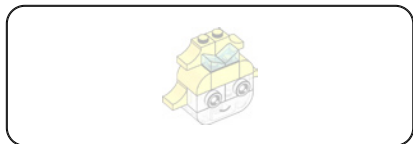

13

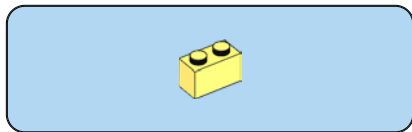

14

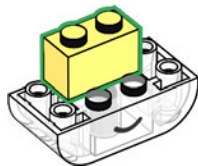

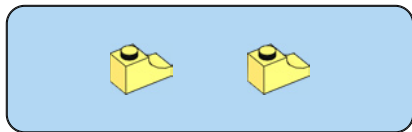

15

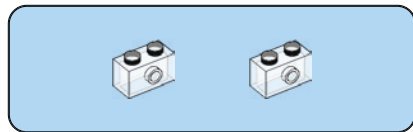
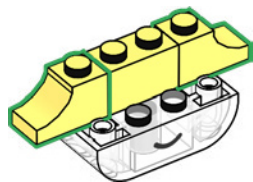

16

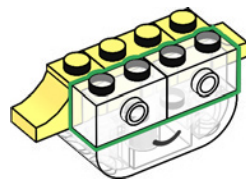



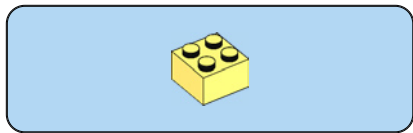

17

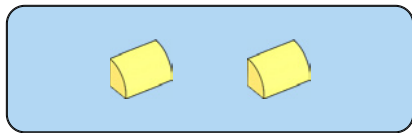
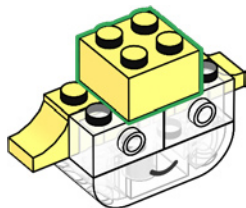

18

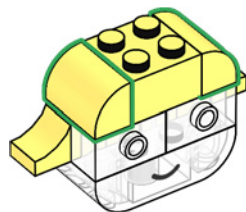

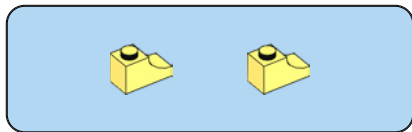

19

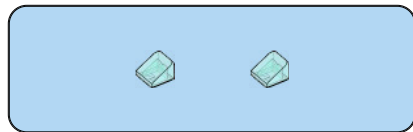
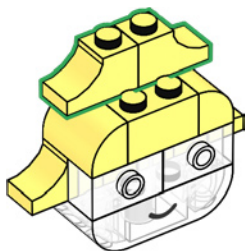

20

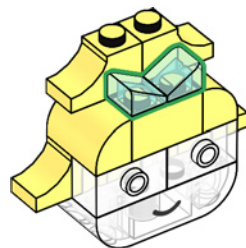

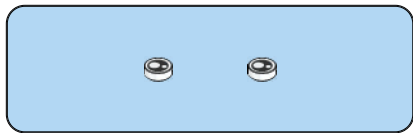

21

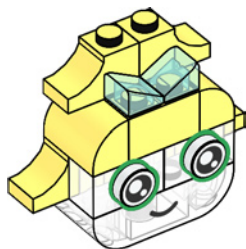

22

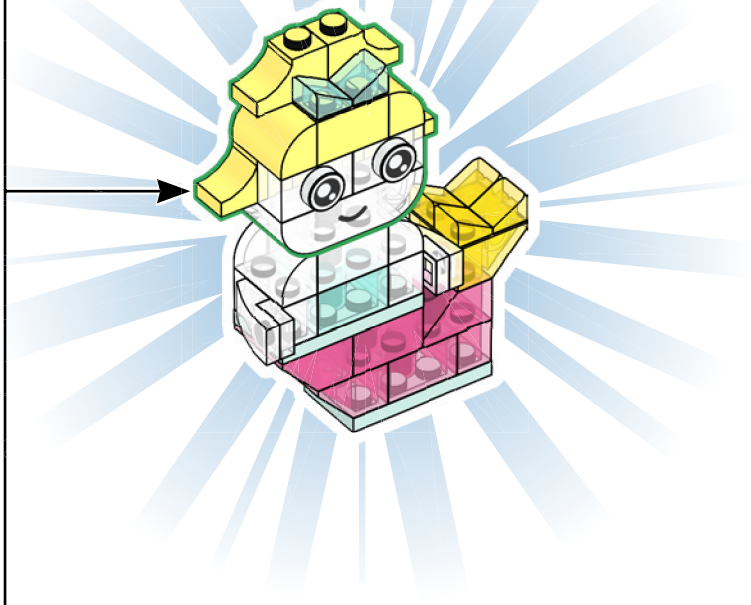

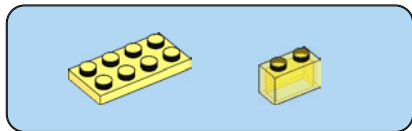
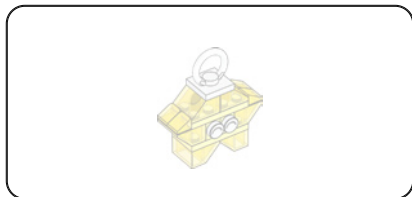

1

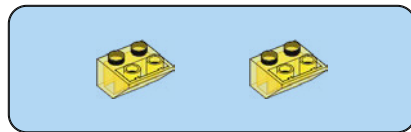
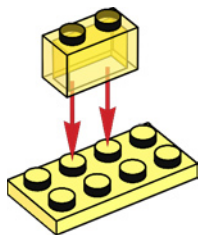

2

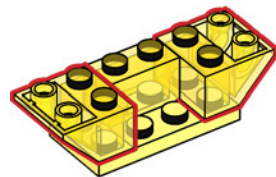

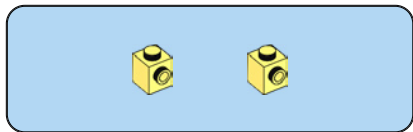

3

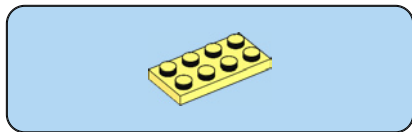
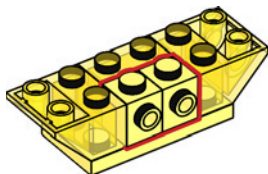

4

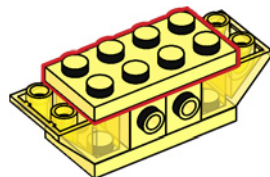





5

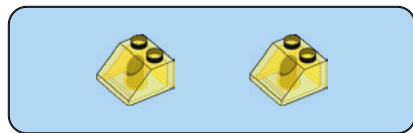
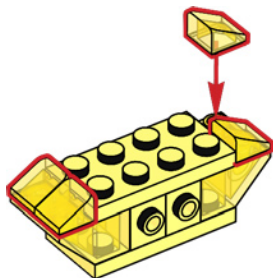

6

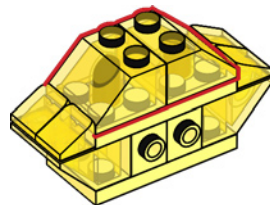

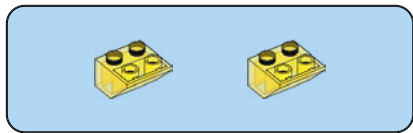

7

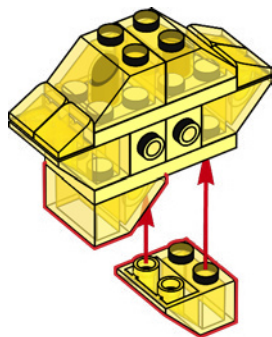

8



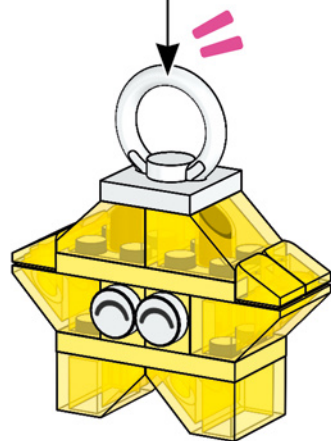
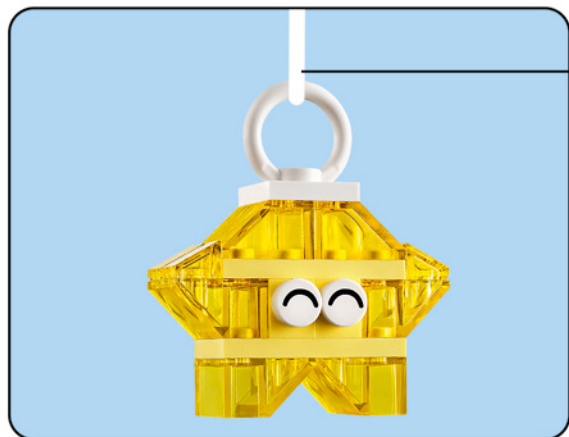





2

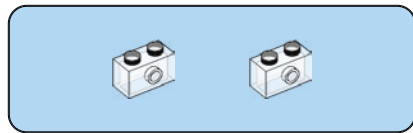
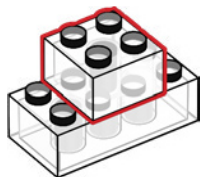

3



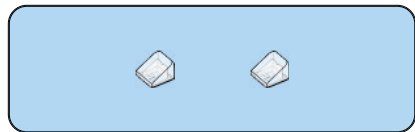

4

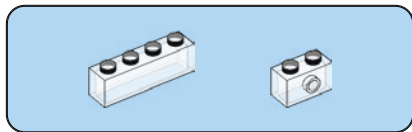
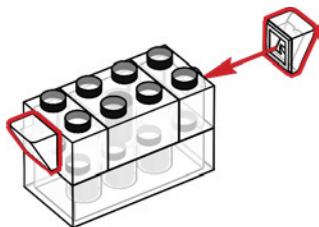

5



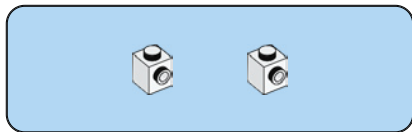

6

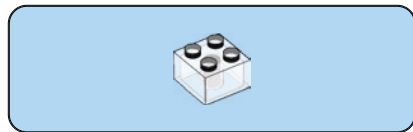

7

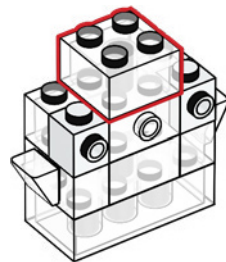

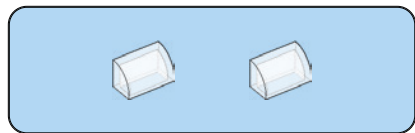

8

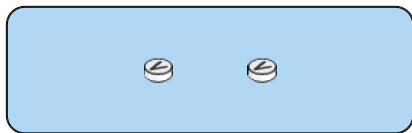
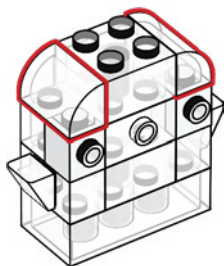

9





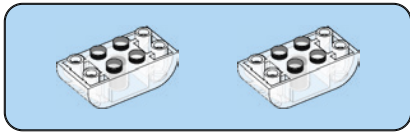

10

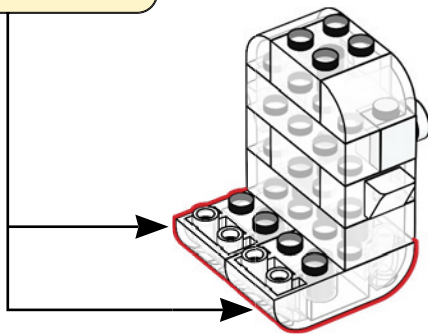
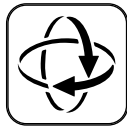
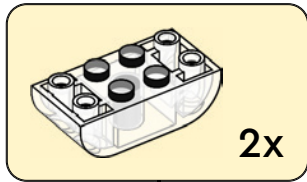

11

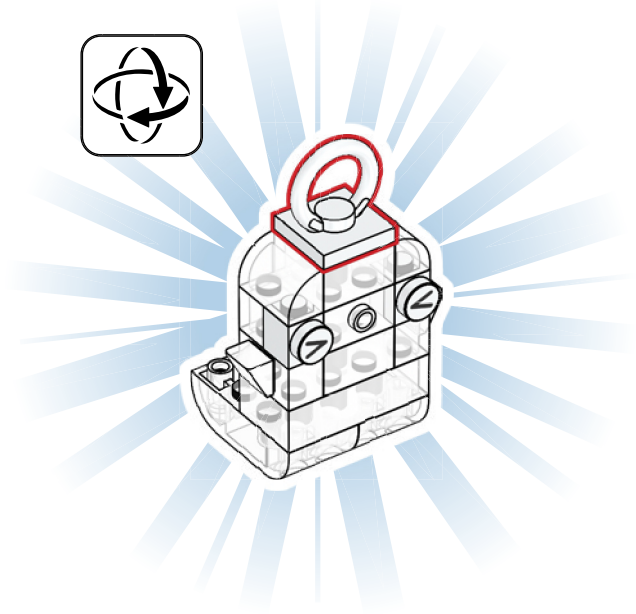
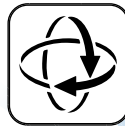

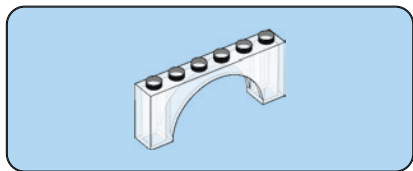
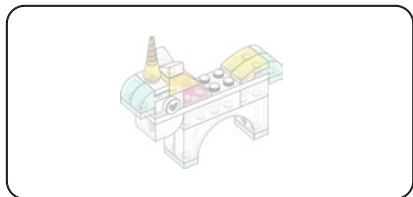

1

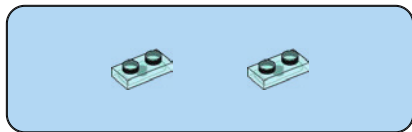
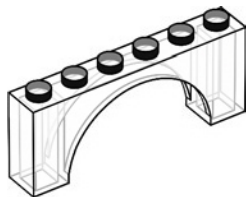

2

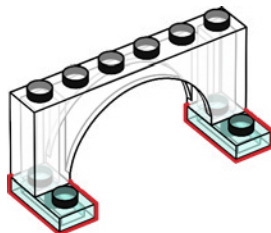

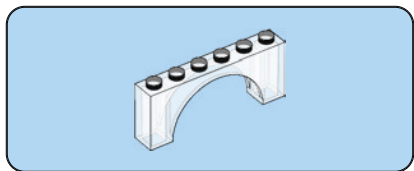

3

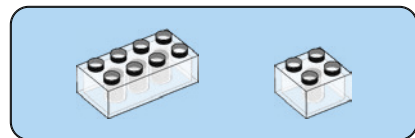
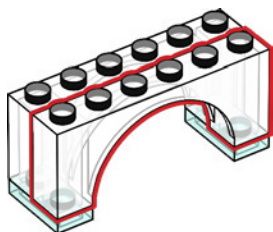

4

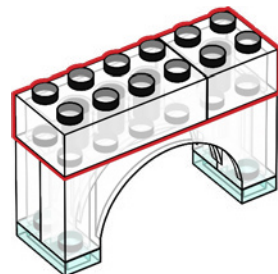

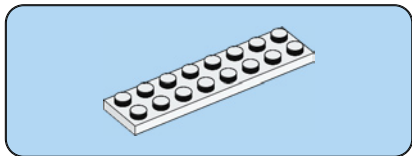
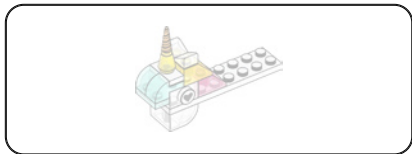

5

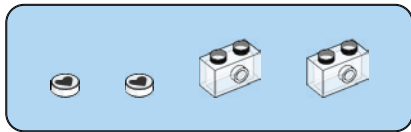
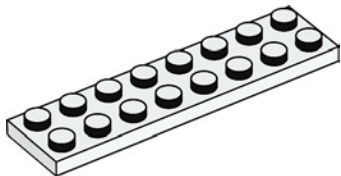

6

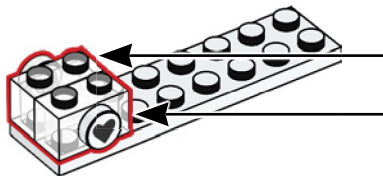
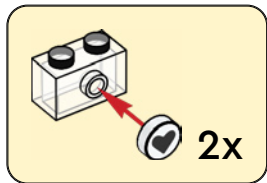



7

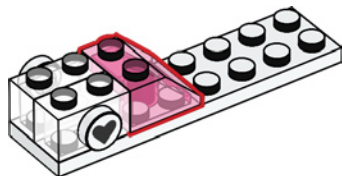

8

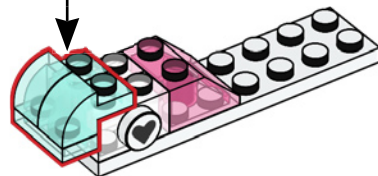
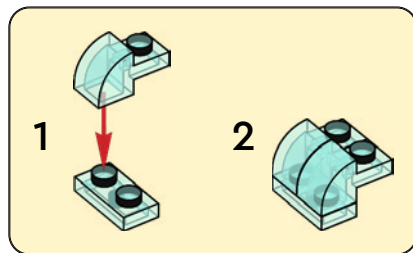



9

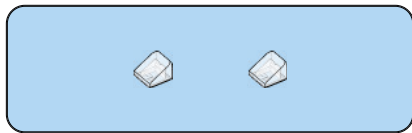
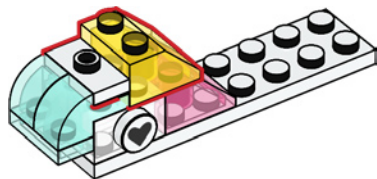

10

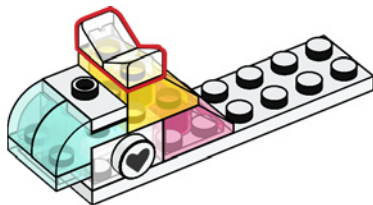



11

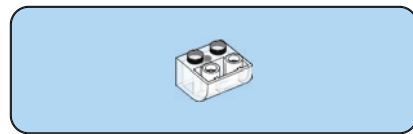
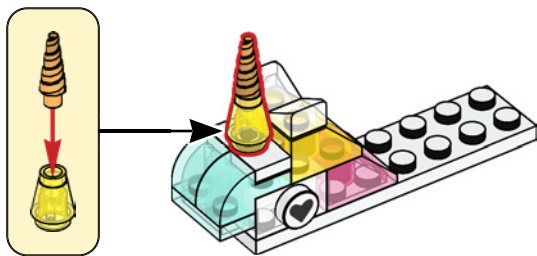

12

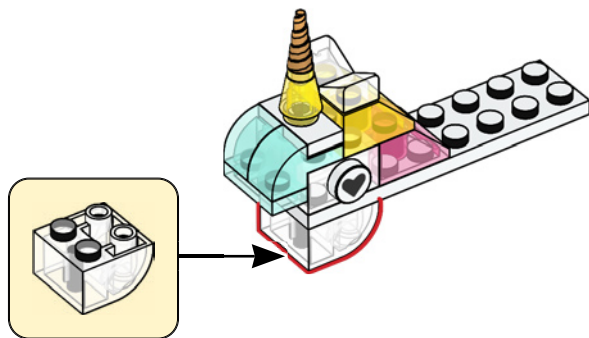

13

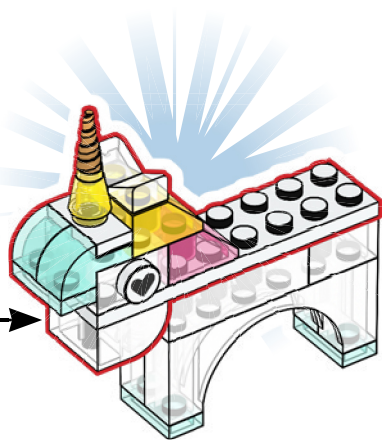

14

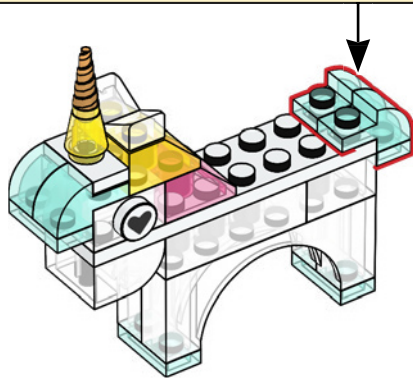
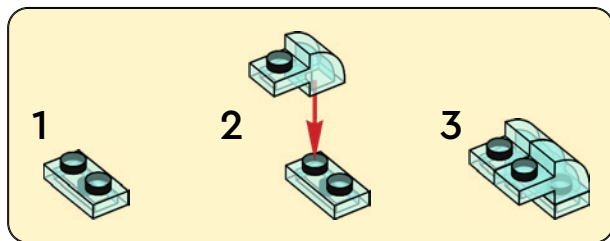



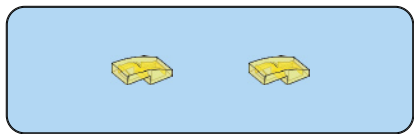

15

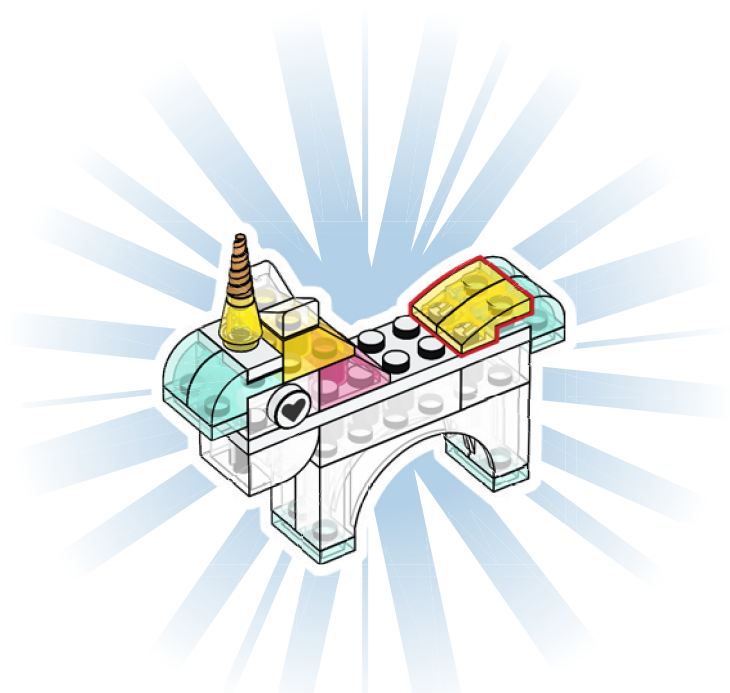

ideas  
included

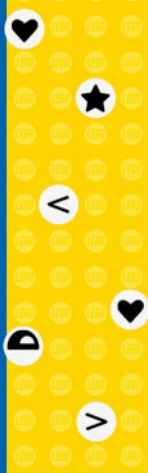



**ideas**  
included





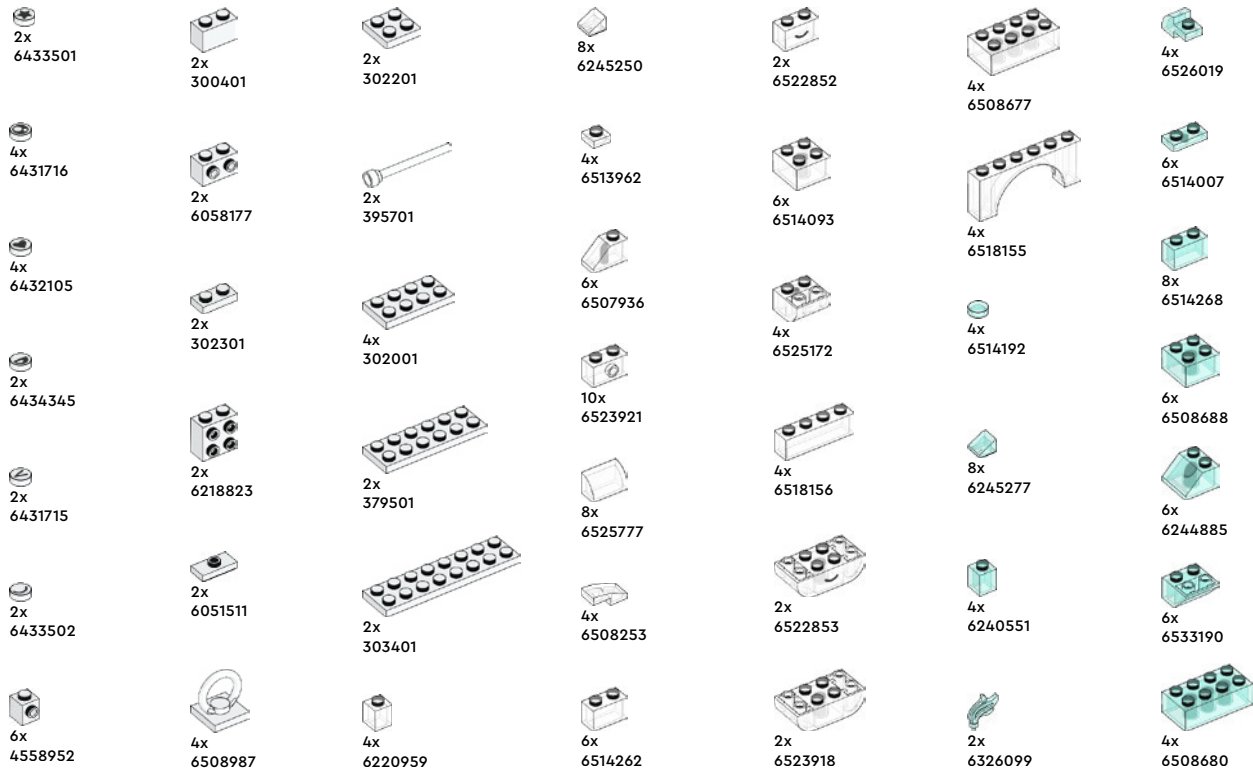





4x  
6514022



12x  
6245272



4x  
6273155



4x  
6508250



8x  
6514265



6x  
6526468



8x  
6533191



4x  
6514196



8x  
6245287



4x  
6240553



2x  
6303223



8x  
6514270



6x  
6490767



4x  
6533192



6x  
6508691



4x  
6508682



6x  
6209679



4x  
6420726



2x  
6022083



4x  
6296494



4x  
6380628



2x  
6212064



2x  
6036232



4x  
6296524

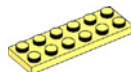

2x  
6175294



4x  
6214208



2x  
6268949



4x  
6251854



4x  
6236575



2x  
6426720



2x  
6426724



4x  
6022032



2x  
6097303



2x  
6218162



2x  
6426721



2x  
6138662



4x  
4619815



 [LEGO.com/service](https://www.LEGO.com/service)

**YOU COULD**  
**WIN**

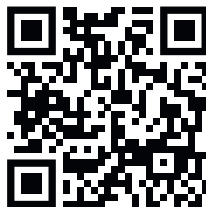

Scan this QR code or go to  
**LEGO.COM/PRODUCTFEEDBACK** and give us  
your short feedback about this LEGO® set  
for a chance to win a cool LEGO prize.

Terms and Conditions apply\*



**EN: YOU COULD WIN.** Terms and Conditions apply\* **DE: Du könntest GEWINNEN.** Es gelten die Teilnahmebedingungen\* **FR: Tu pourrais GAGNER.** Des conditions s'appliquent\* **IT: Potresti VINCERE tu.** Termini e condizioni sono applicabili\* **ES: Puedes GANAR.** Aplican términos y condiciones\* **PT: PODERÁ GANHAR.** Aplicam-se Termos e Condições\* **ZH: 轻松获奖.** 条款和条件适用\* **PL: Szansa na WYGRANĄ.** Obowiązuje regulamin\* **CS: Máte šanci VYHRÁT.** Platí všeobecné smluvní podmínky\* **SK: Máte šancu VYHRAŤ.** Platia všeobecné zmluvné podmienky\* **HU: TE IS NYERHETSZ.** Felhasználási feltételek érvényesek\* **UA: ВИ МОЖЕТЕ ВИГРАТИ.** Застосовуються загальні положення та умови\* **RO: Ai putea CÂȘTIGA.** Se aplică termeni și condiții\* **BG: Можете да СПЕЧЕЛИТЕ.** Има определени правила и условия\* **LV: Tu vari LAIMĒT.** Ir spēkā noteikumi un nosacījumi.\* **ET: Sul on võimalus VÕITA.** Kehtivad tingimused\* **LT: Jūs galite LAIMĖTI.** Taikomos sąlygos\*

\*[LEGO.com/productfeedback/terms](https://www.lego.com/productfeedback/terms)