



DREAMZZZ

71489







LEGO® Builder



LEGO.com/sustainable-packaging



 ^{FR} **DONNEZ**
OU
RECYCLEZ

 OU  OU 

ASSOCIATION MAGASIN DÉCHÈTERIE

Adresses sur quefairedemesdechets.fr

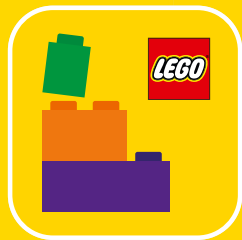

Q LEGO® Builder

BUILDER



Apple and the Apple logo are trademarks of Apple Inc., registered in the U.S. and other countries and regions. App Store is a service mark of Apple Inc. Google Play and the Google Play logo are trademarks of Google LLC. Tencent and the Tencent logo are trademarks of Tencent Inc.

Q [LEGO.com/devicecheck](https://www.lego.com/devicecheck)

EN Ask parents' permission before going online | DE Eltern um Erlaubnis bitten, bevor du online gehst | FR Demande l'autorisation d'un parent avant d'aller en ligne | IT Chiedi il permesso ai tuoi genitori prima di andare online | ES Pídeles permiso a tus papás antes de conectarte a Internet | PT Pede autorização aos pais antes de acederes online | ZH 上网前应先征得父母的同意 | PL Poproś rodziców o zgodę, zanim wejdiesz do Internetu | CS Než půjdeš na internet, požádej rodiče o svolení | SK Skôr než pôjdeš na internet, vypýtaj si povolenie od rodičov | HU Kérj szülői engedélyt, mielőtt online csatlakoznál! | RO Cere permisiunea părinților înainte de a te conecta online | BG Поискайте разрешение от родител, преди да влезете онлайн | LV Pirms došanās tiešsaistē palūdz atļauju vecākiem | ET Enne Interneti kasutamist küsi vanematelt luba | LT Prieš prisijungdami prie interneto, atsiklauskite tėvų

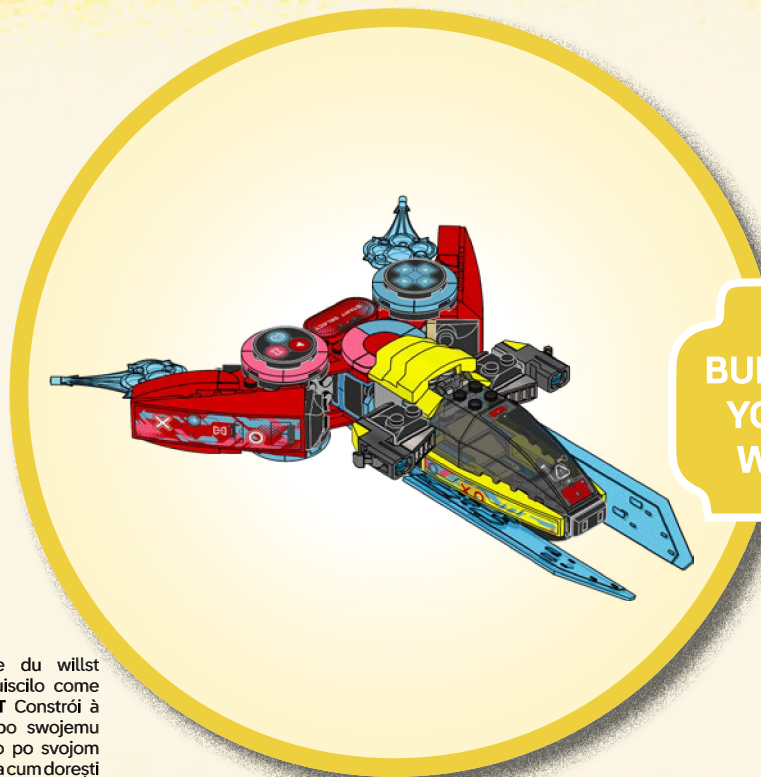

**BUILD IT
YOUR
WAY**

EN Build It Your Way | **DE** Bau, wie du willst
| **FR** Construisez à votre façon | **IT** Costruiscilo come
vuoi tu | **ES** Constrúyelo a tu manera | **PT** Constrói à
Tua Maneira | **ZH** 自由拼搭 | **PL** Zbuduj po swojemu
| **CS** Postavte to po svém | **SK** Postavte to po svojom
| **HU** Építs kedved szerint! | **RO** Construięște așa cum dorești
| **BG** Постройте го по своя начин | **LV** Būvē tieši tā, kā
vēlies | **ET** Ehita enda moodi | **LT** Sukonstruokite savaip

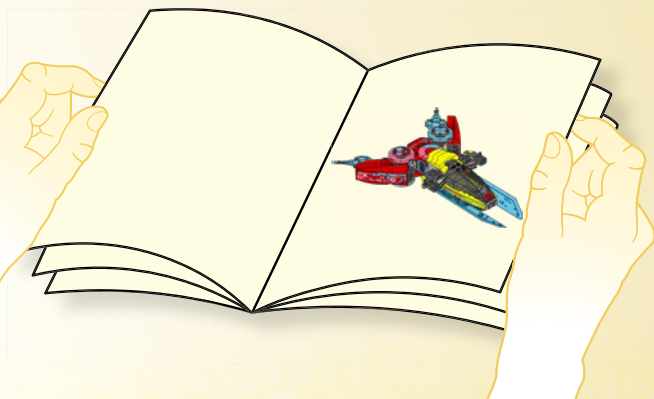
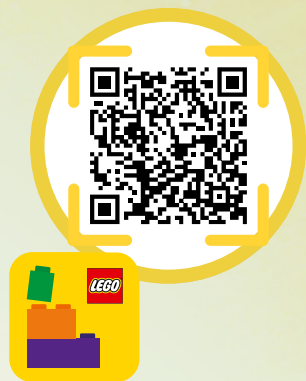





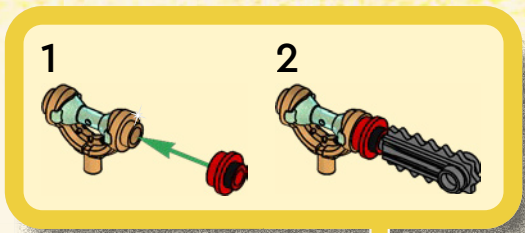
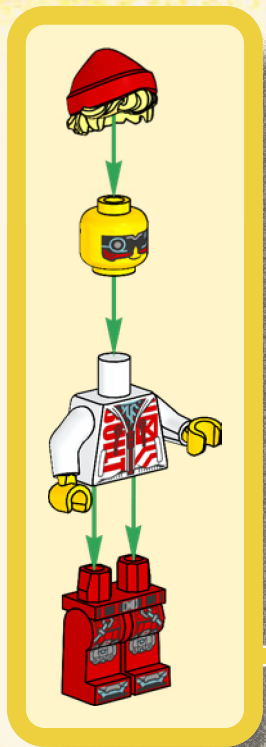



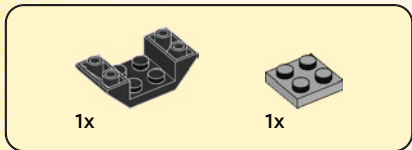
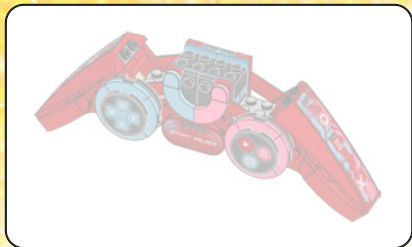

1

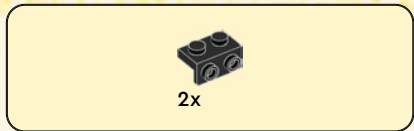
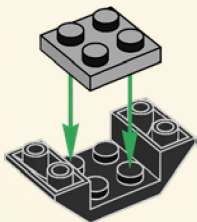

2

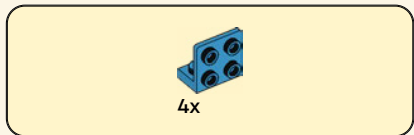
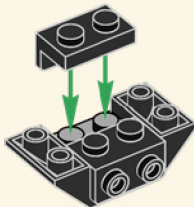

3

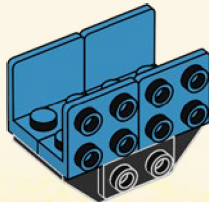



1x

4

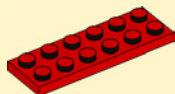
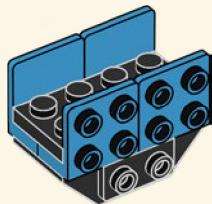

1x

5

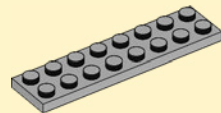
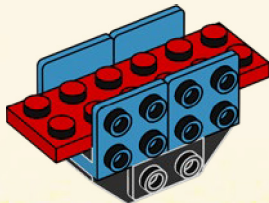

1x

6

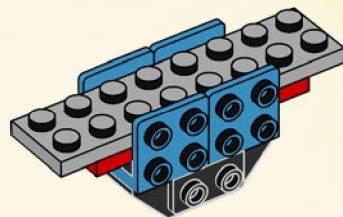

1x

7

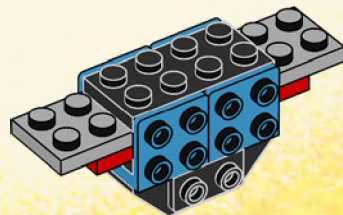



4x

8

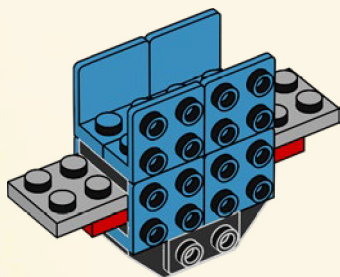

1x

9

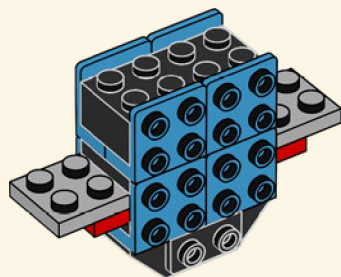



1x



2x

10

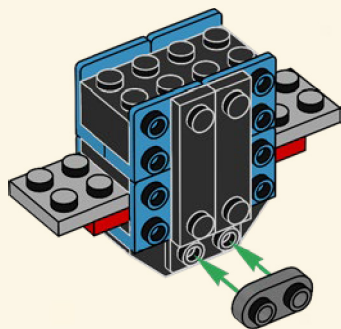

1x



2x

11

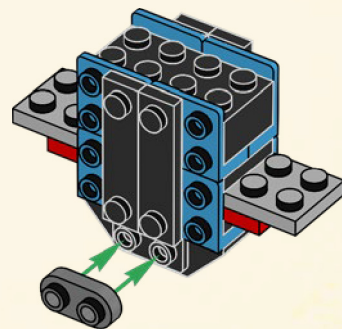



12

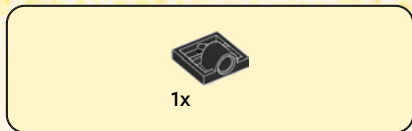
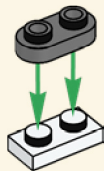

13

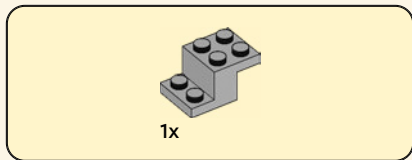
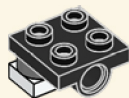

14

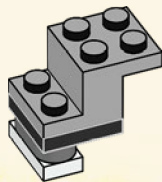



1x

15

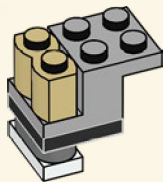

2x

16

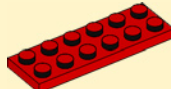
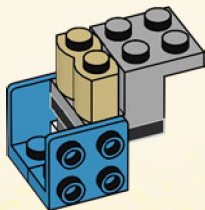

1x



1x

17

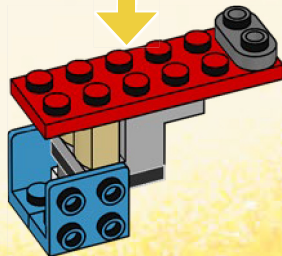
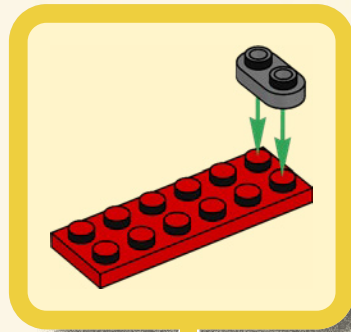



2x

18

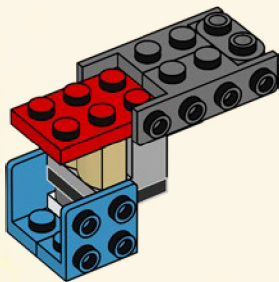

1x

19

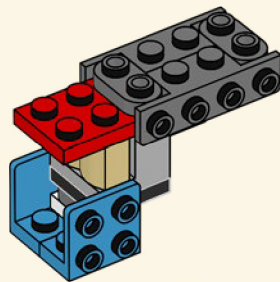



2x

20

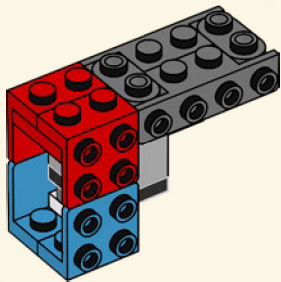

1x

21

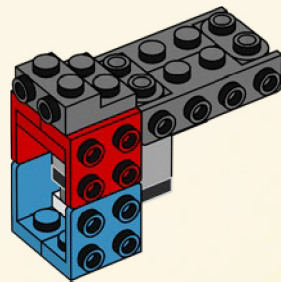



1x

22

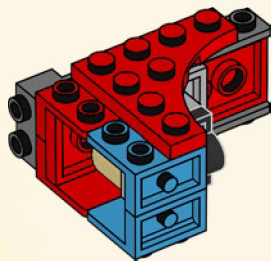

1x



1x

23

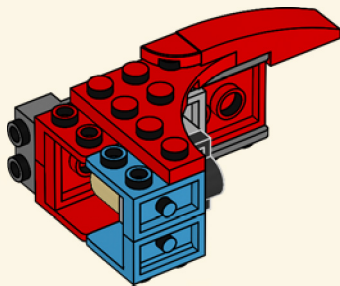



1x

24

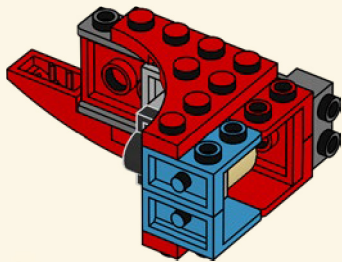

1x



1x

25

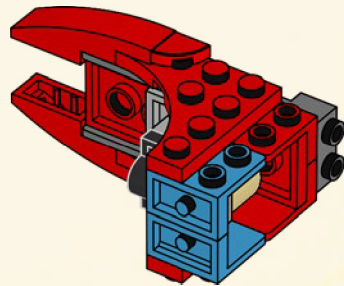

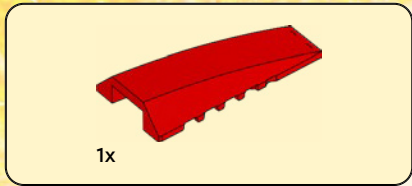

26

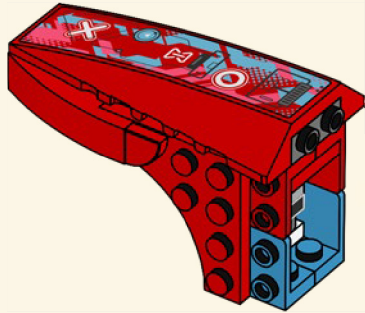
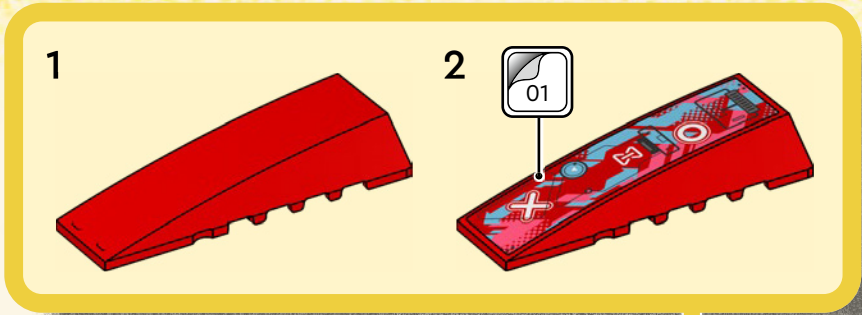

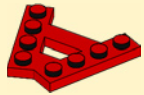

1x

27

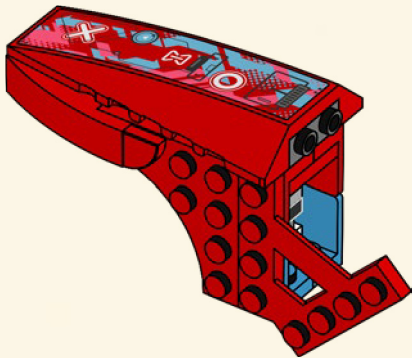

28

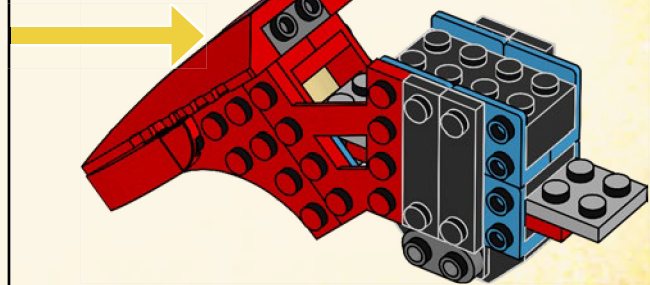

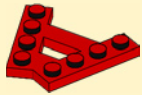

1x

29

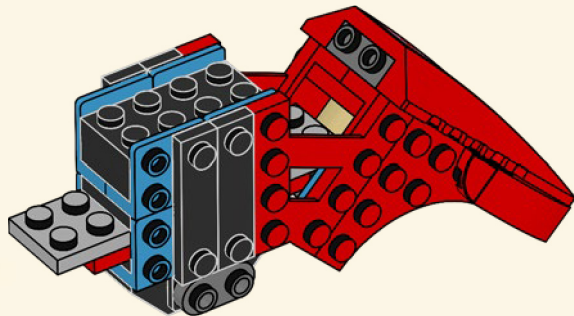

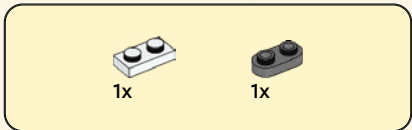
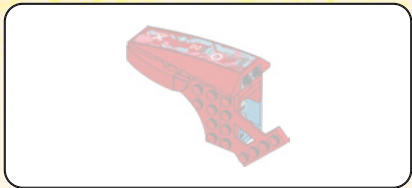

1x

1x

30

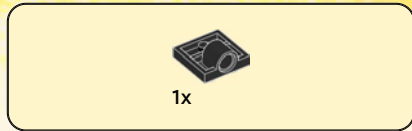
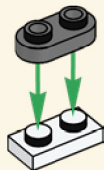

1x

31

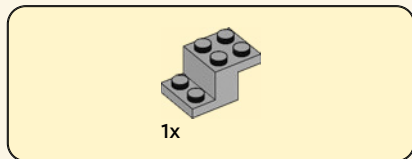
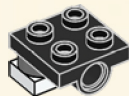

1x

32

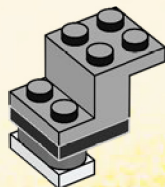



1x

33

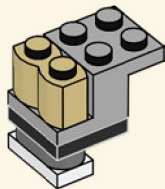

2x

34

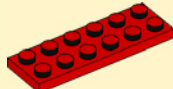
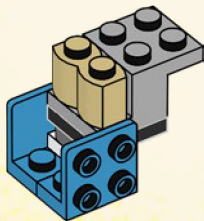

1x



1x

35

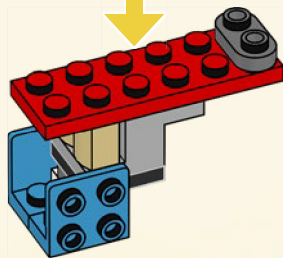
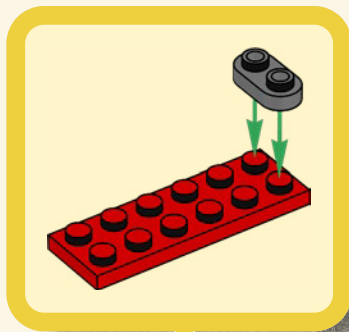



2x

36

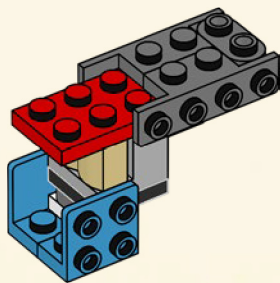

1x

37

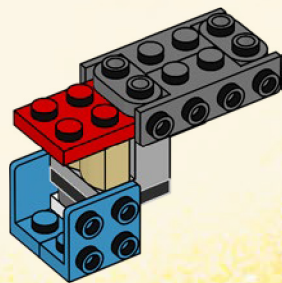



2x

38

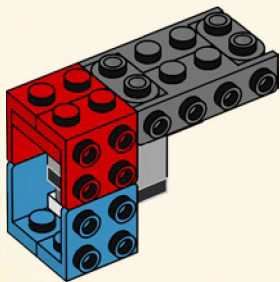

1x

39

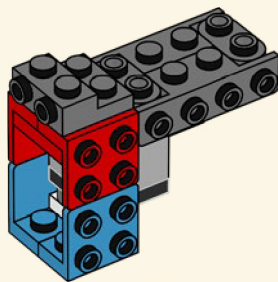



1x

40

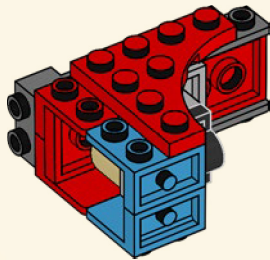

1x



1x

41

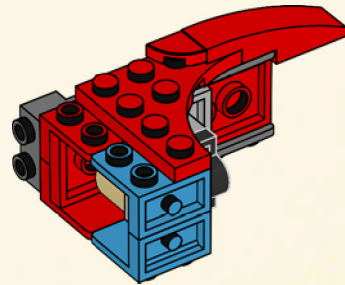



1x

42

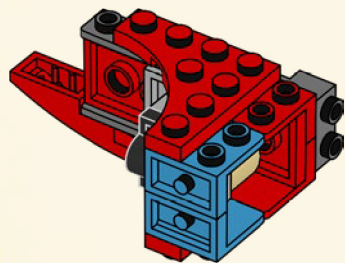

1x



1x

43

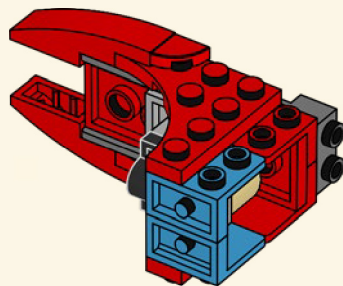

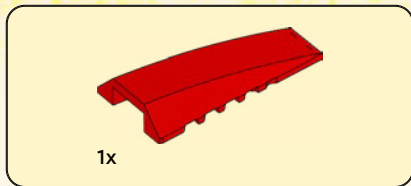

44

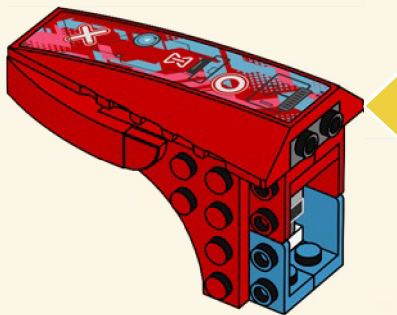
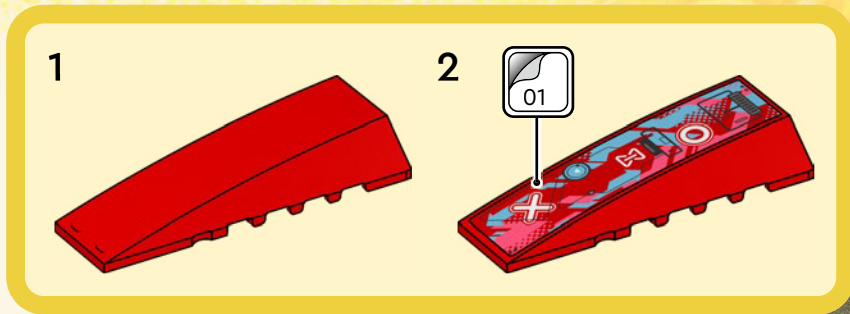

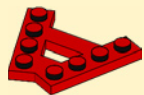

1x

45

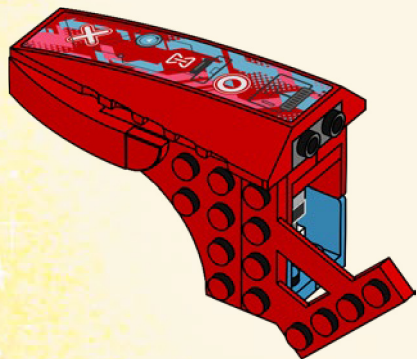

46

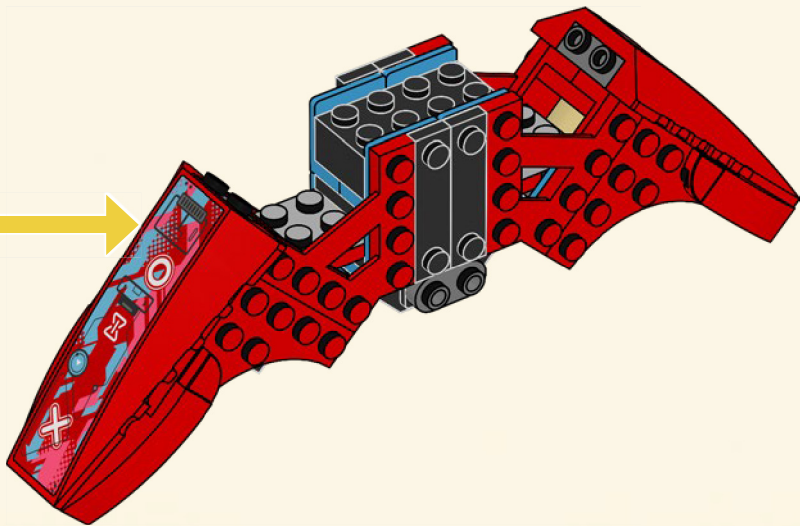

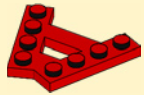

1x

47

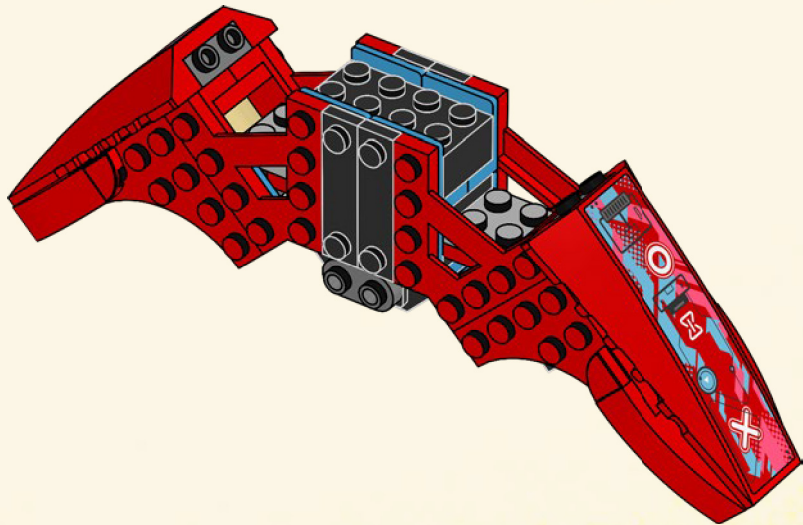



1x

48

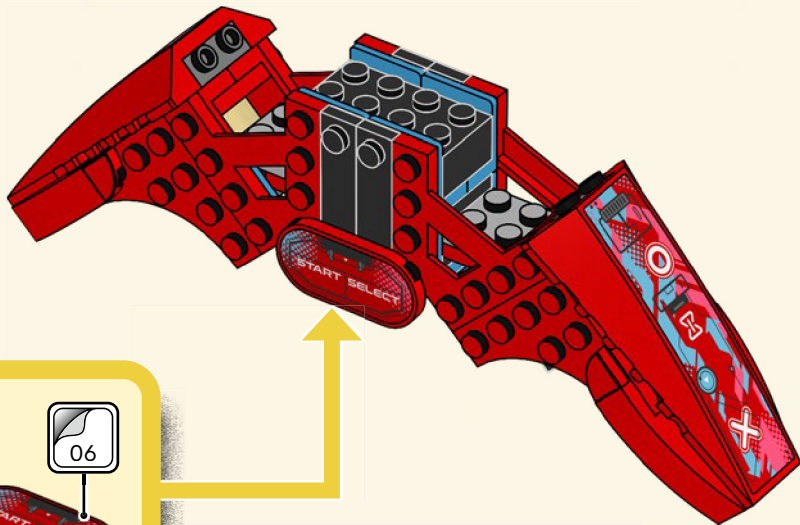

1



2





1x



1x



1x



1x

49

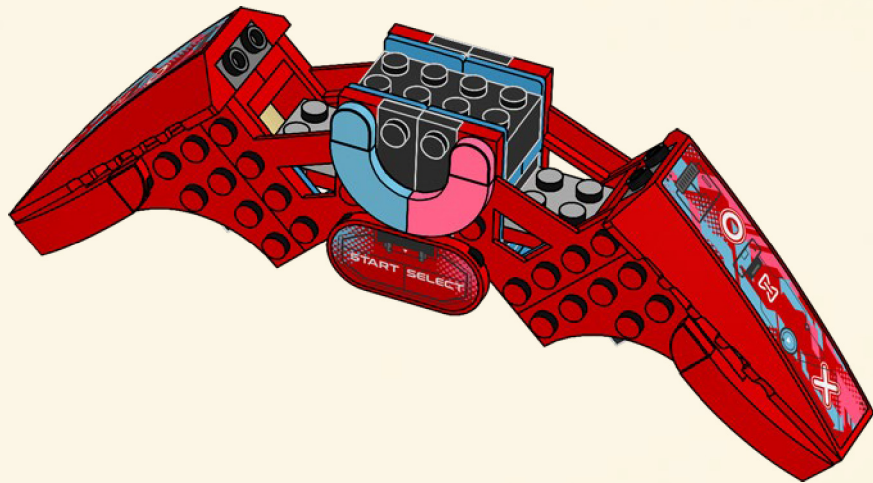

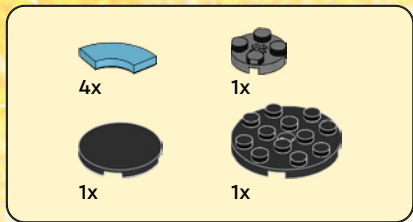

50

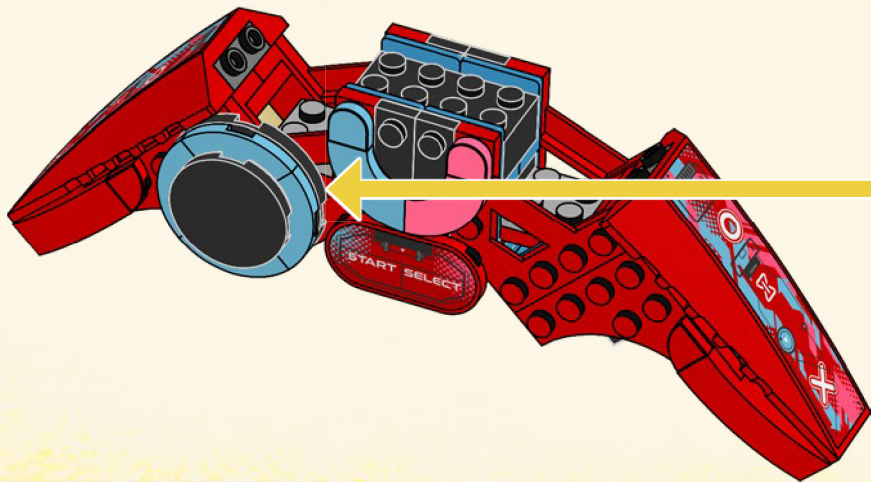
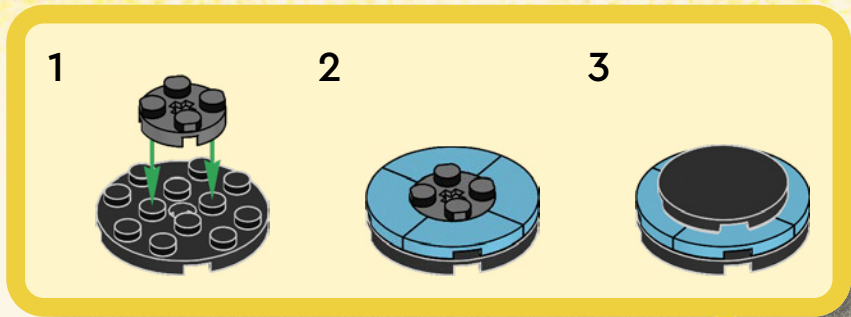

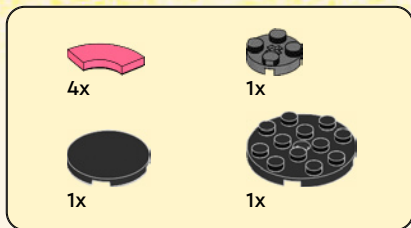

51

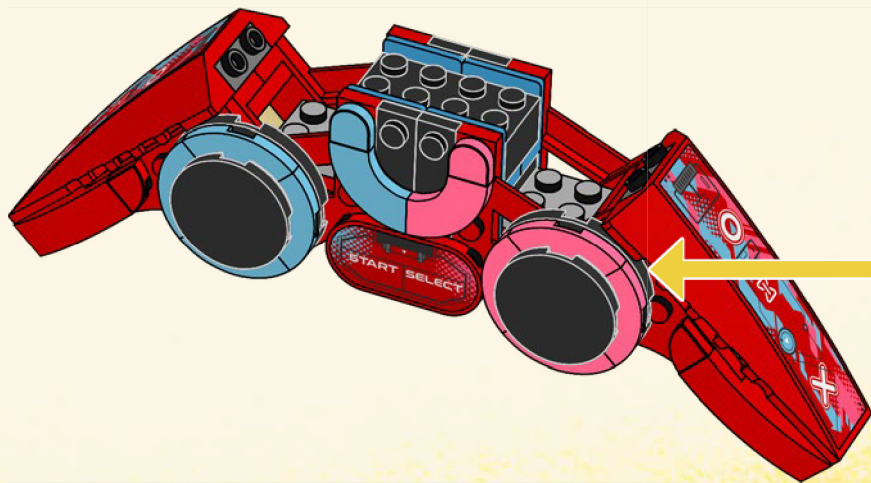
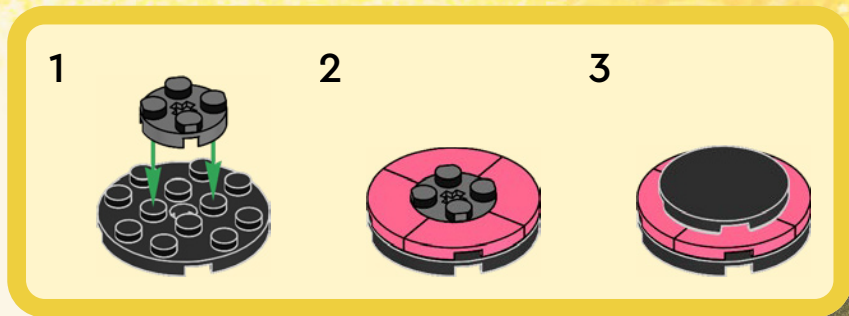

52

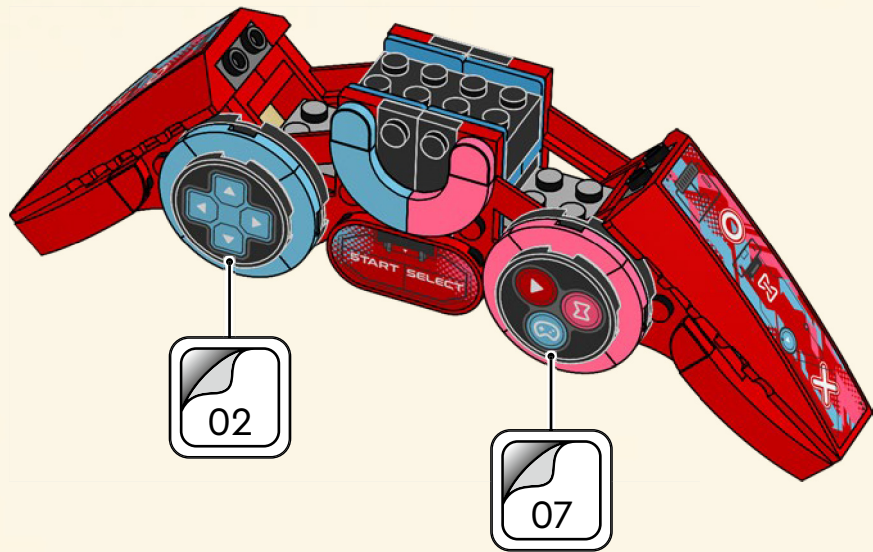



1x

53

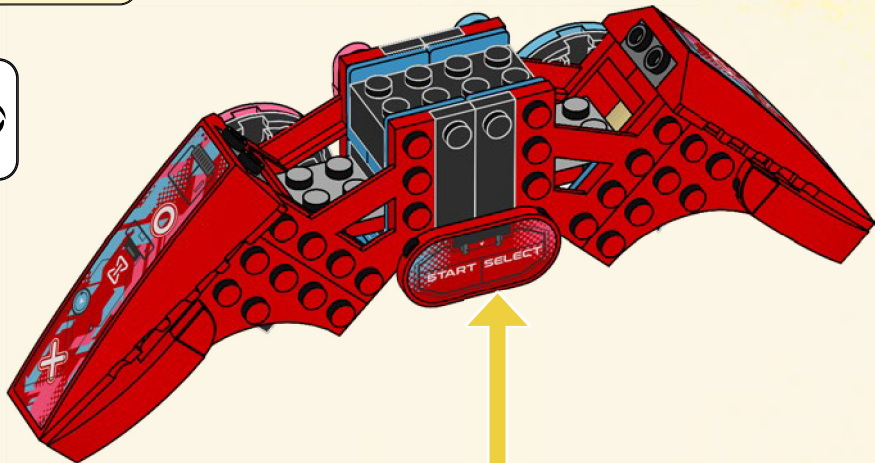
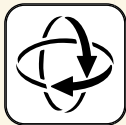

1



2





1x



1x



1x



1x

54

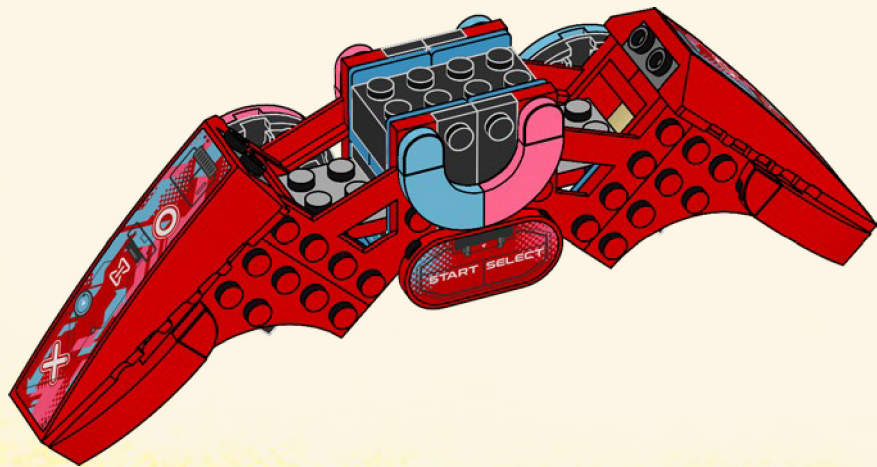

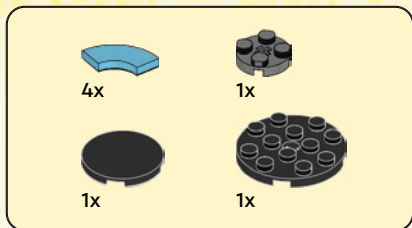

55

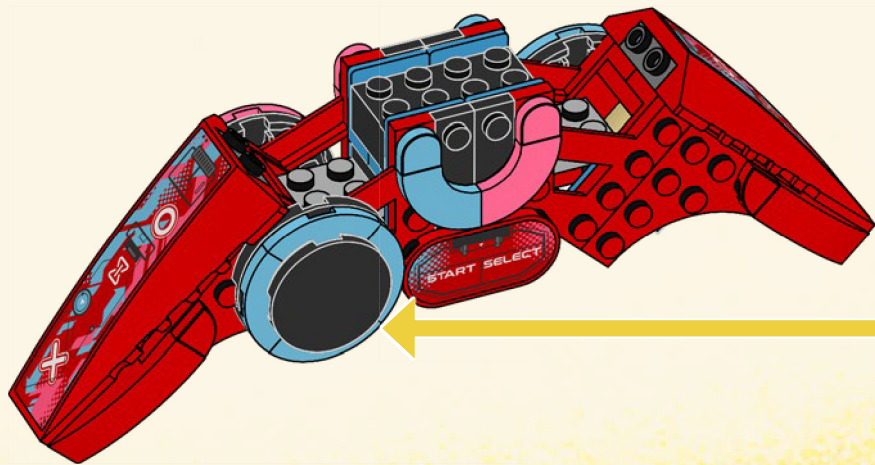
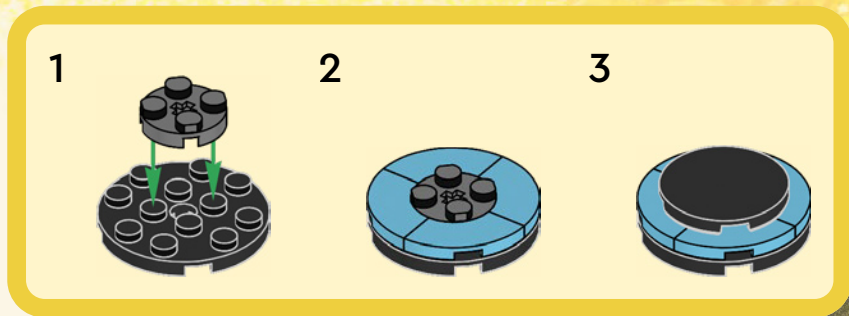

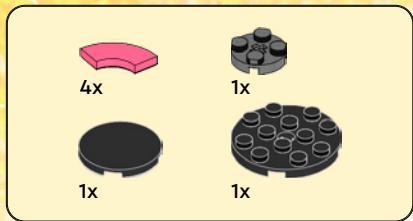

56

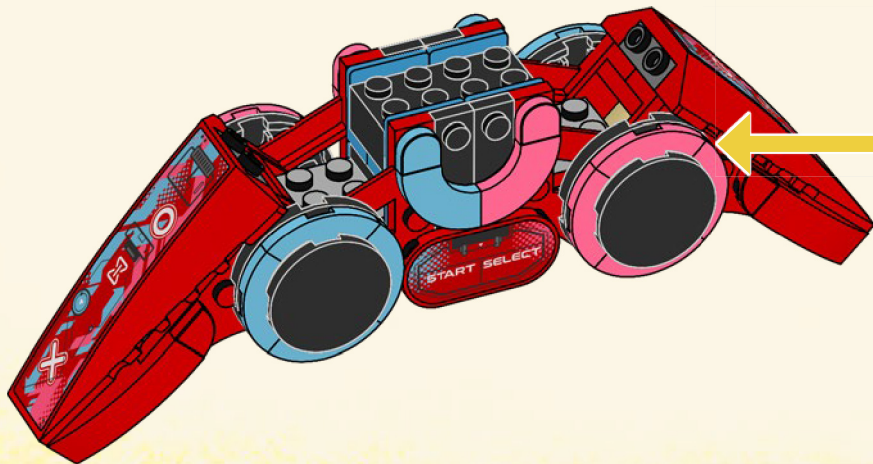
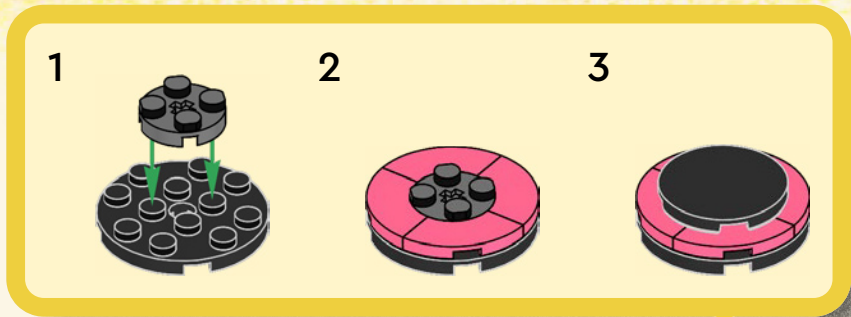

57

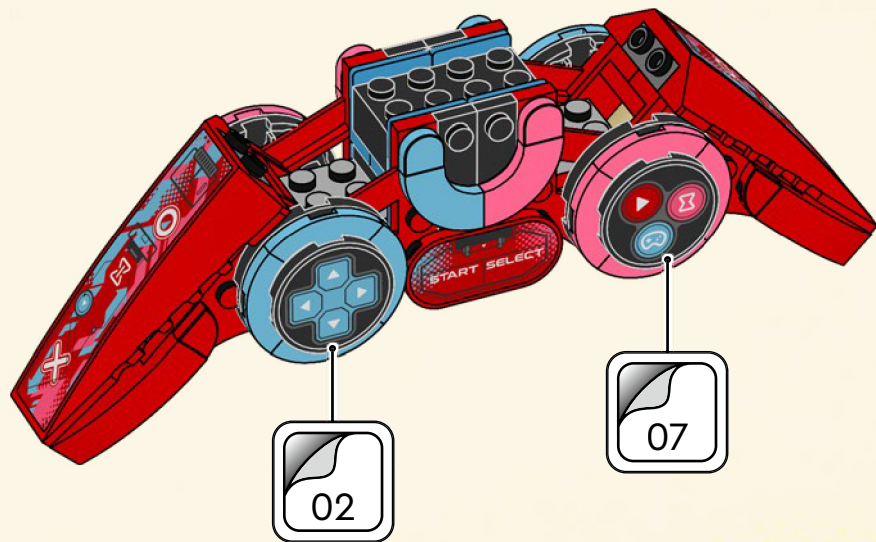



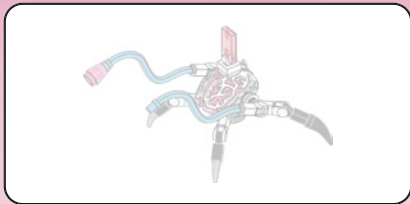

1x



1x

1

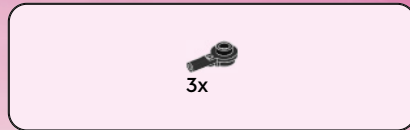
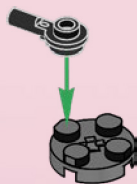

3x

2





3

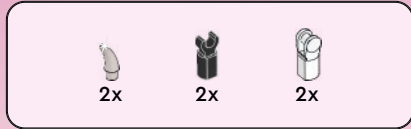
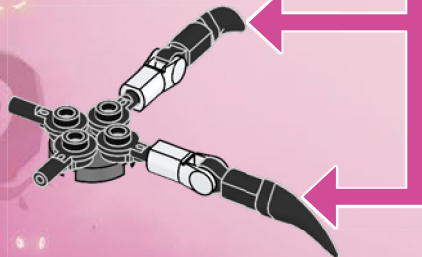
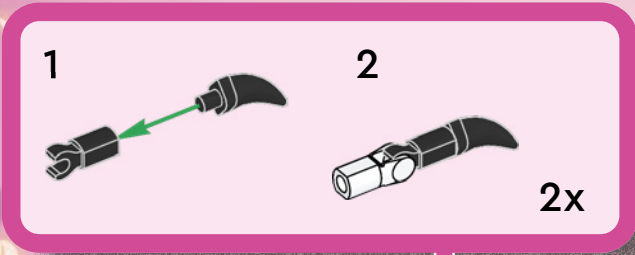

4

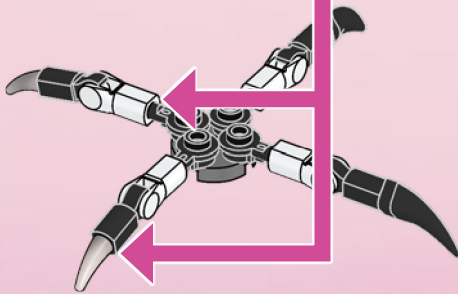
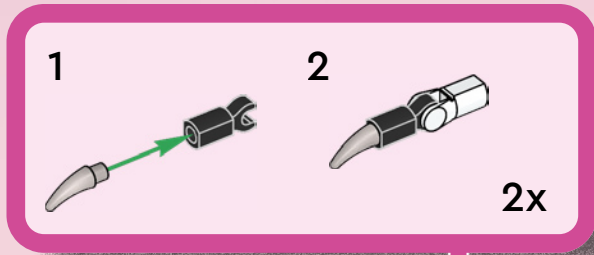

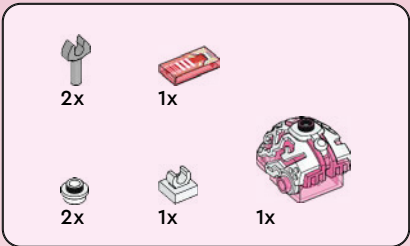

5

1



2



3

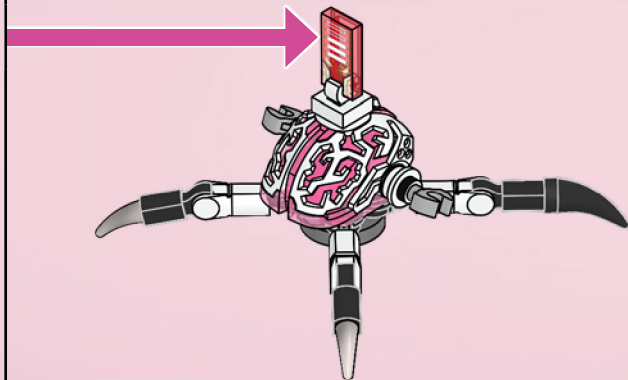
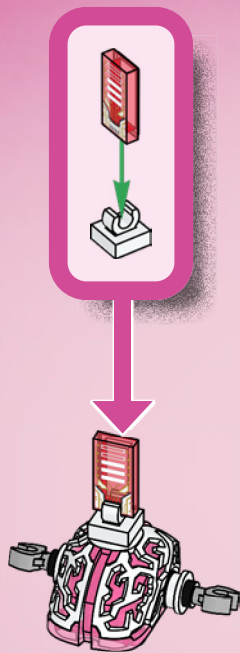

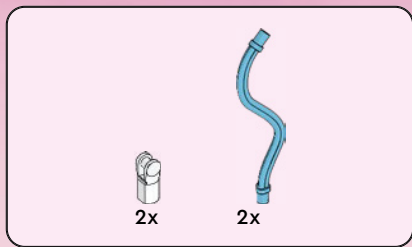

6

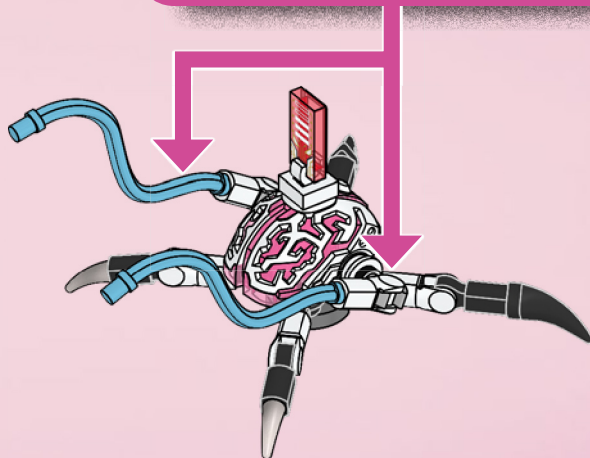
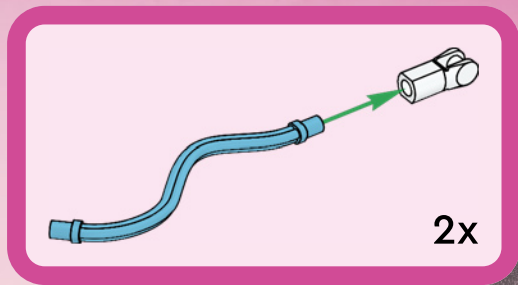



7

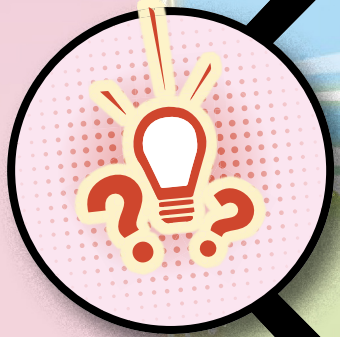
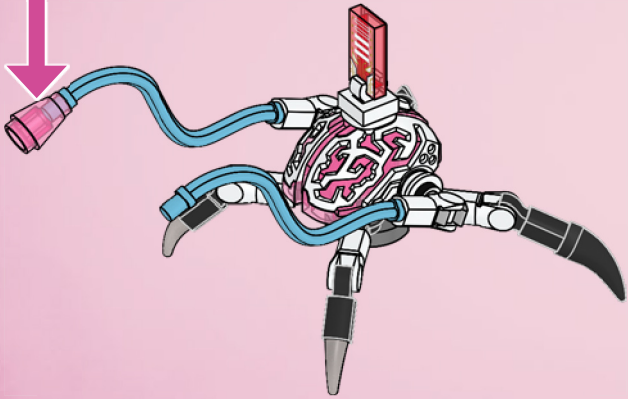

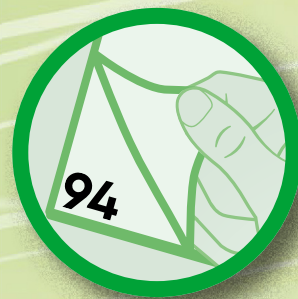





2x

58

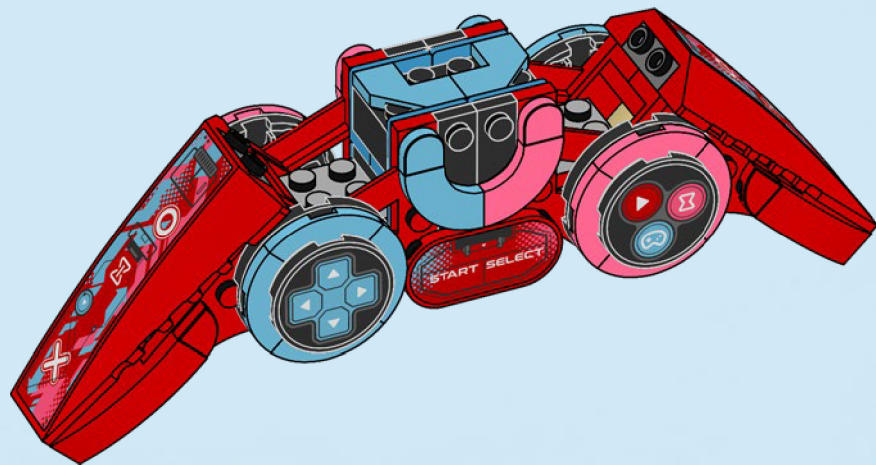



2x

59

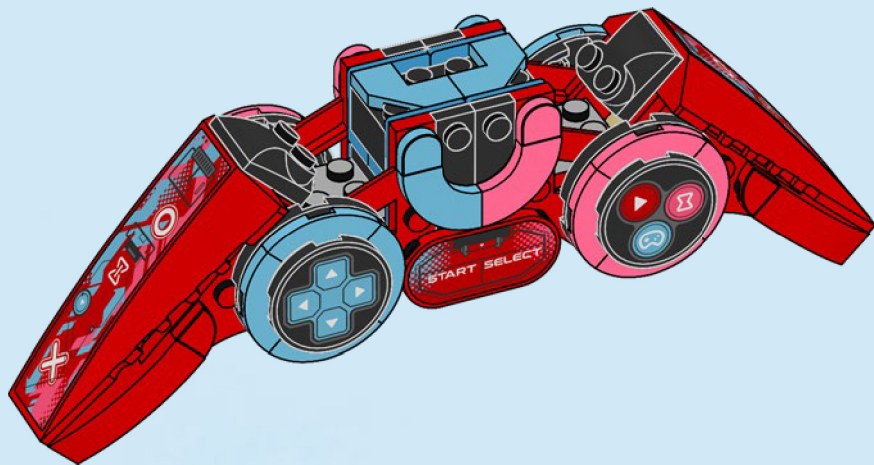

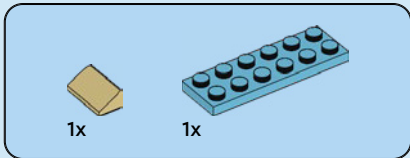
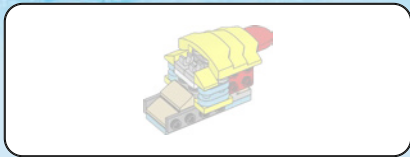

60

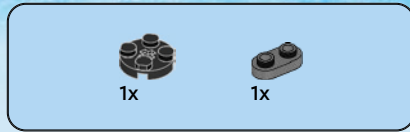
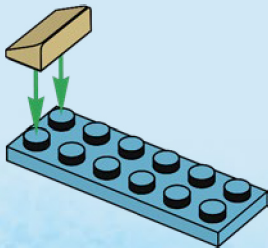

61

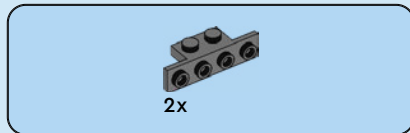
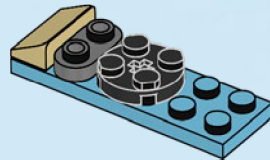

62

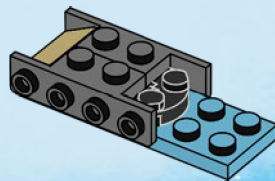



1x

63

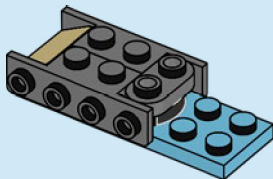

1x



1x

64

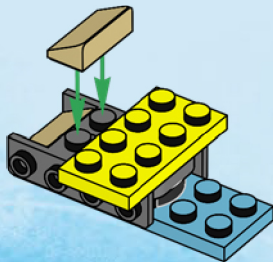

1x

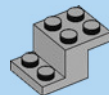

1x

65

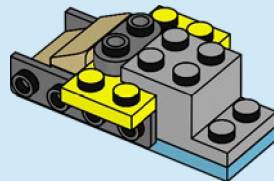

1x

66

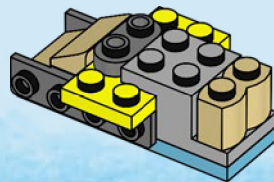



2x

67

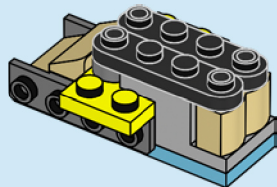

1x

68

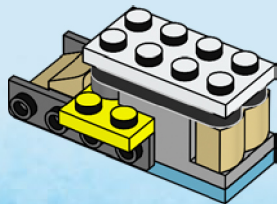

2x

69

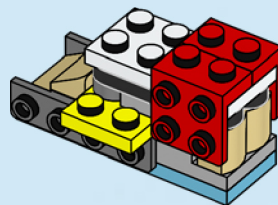



2x

70

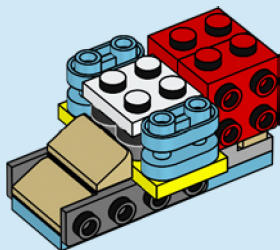

2x

71

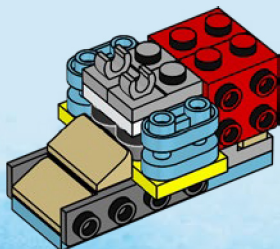

2x



2x

72

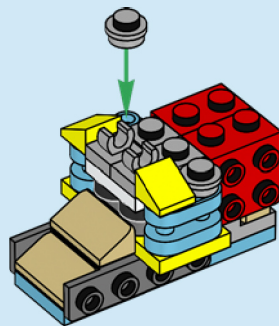

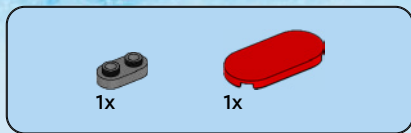

73

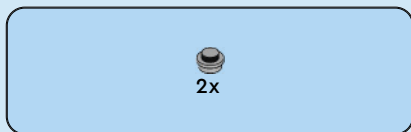
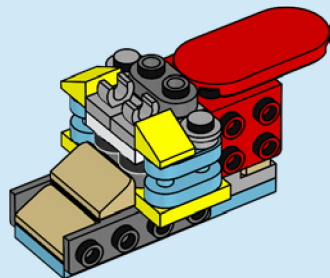

74

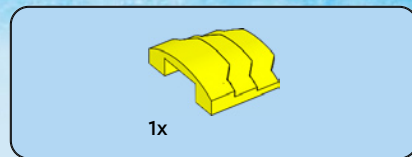
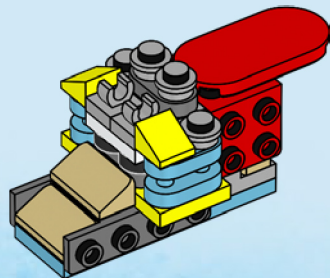

75

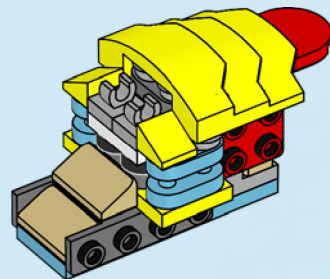

76

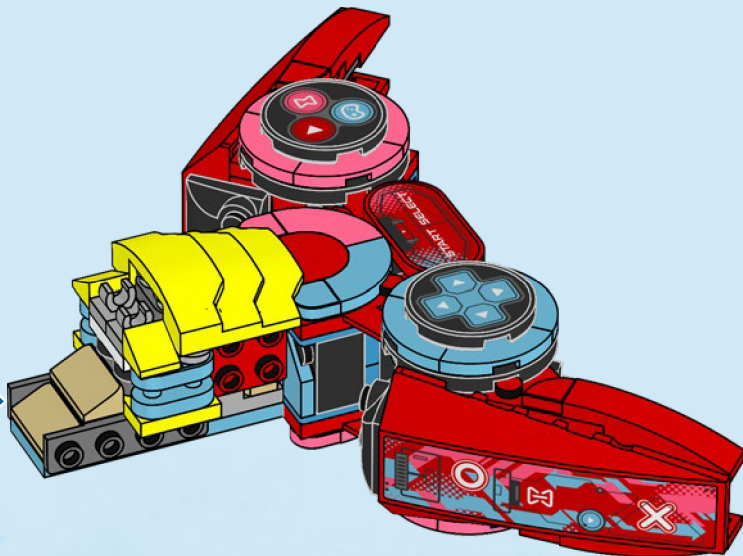
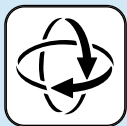



1x

77

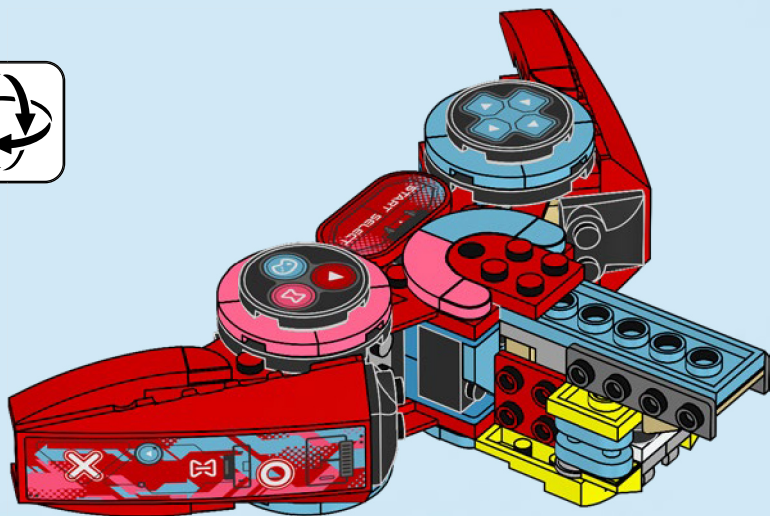
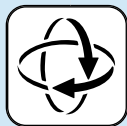



1x



1x

78

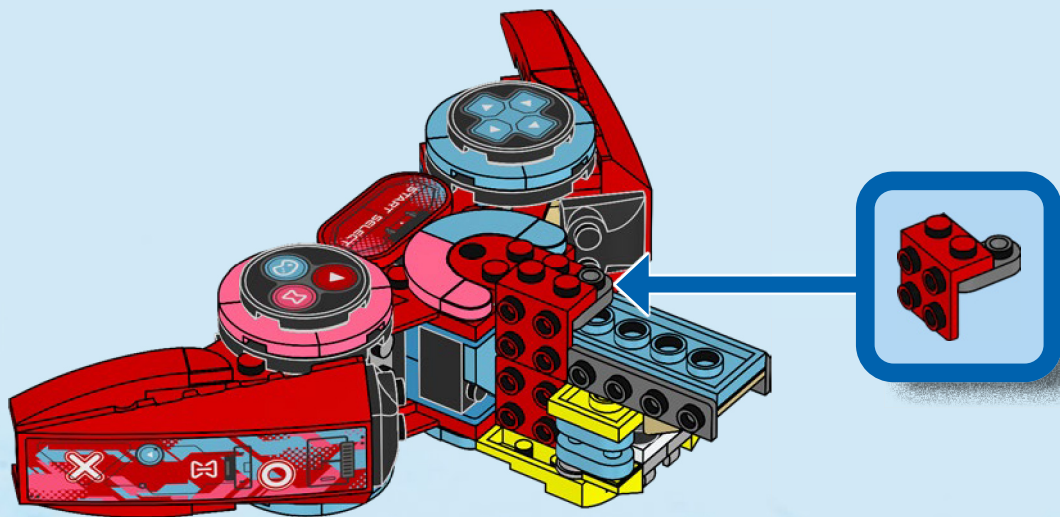



1x

79

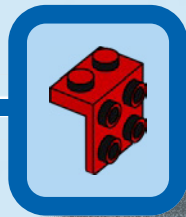
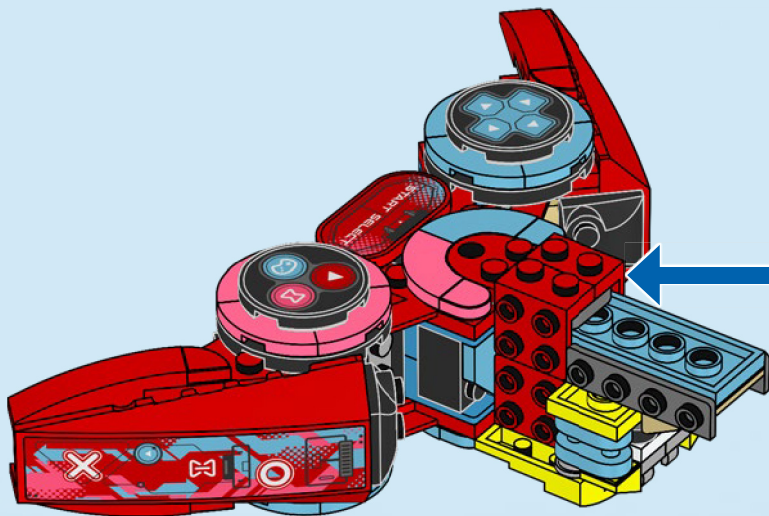

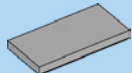

1x

80

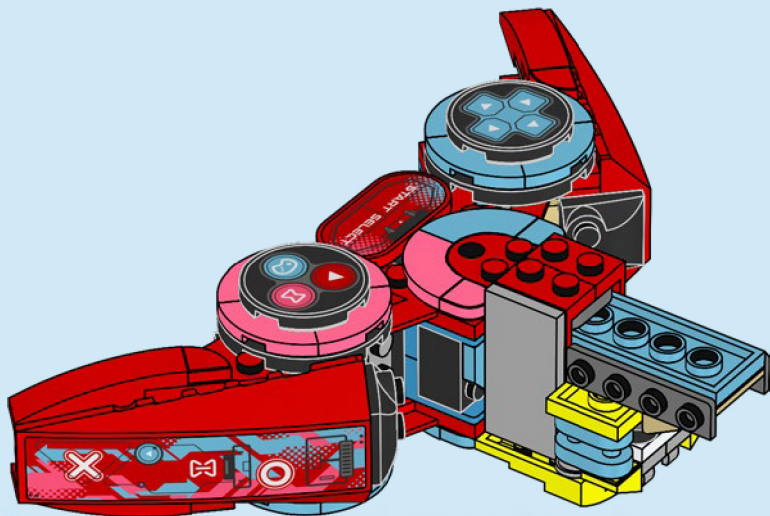



1x

81

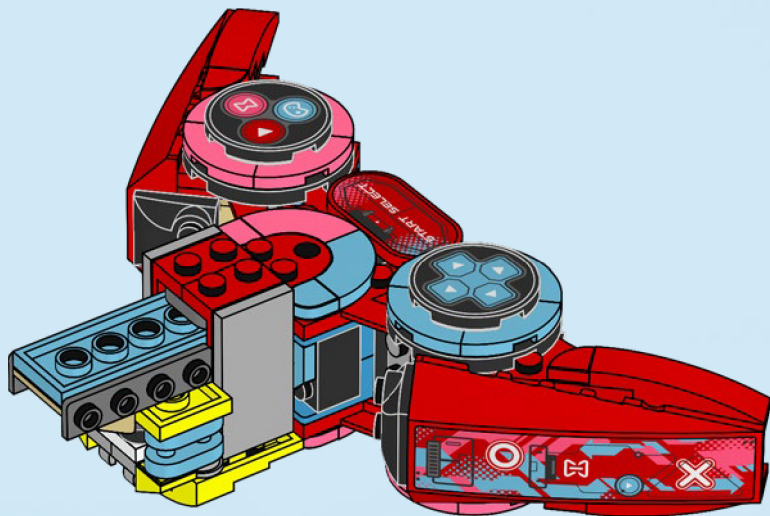



1x

82

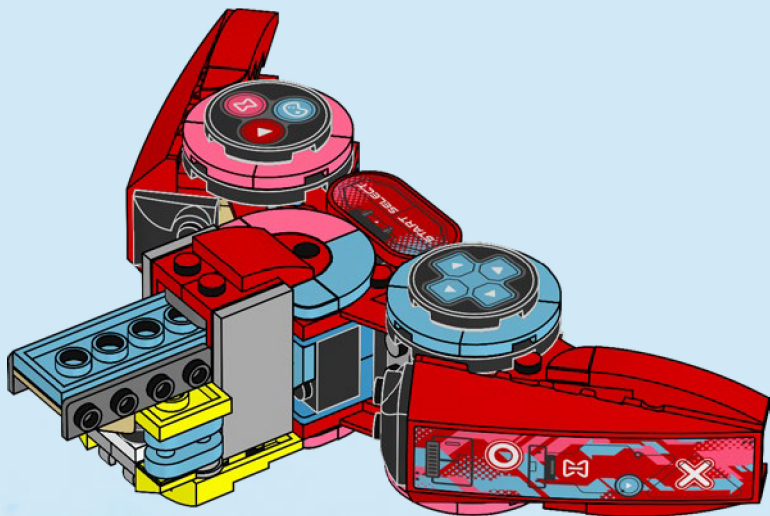

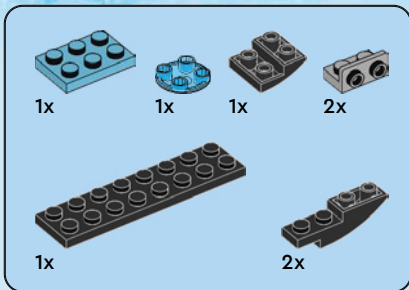

83

1

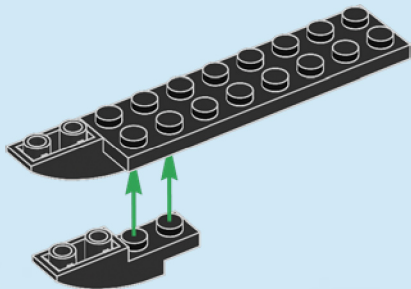

2

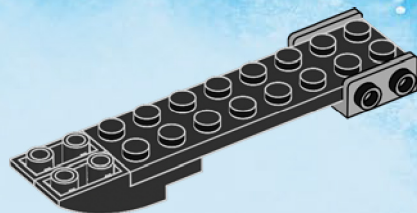

3

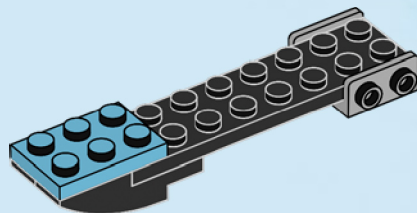

4

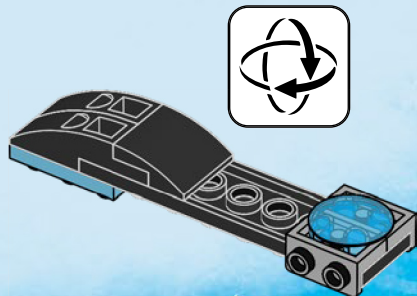

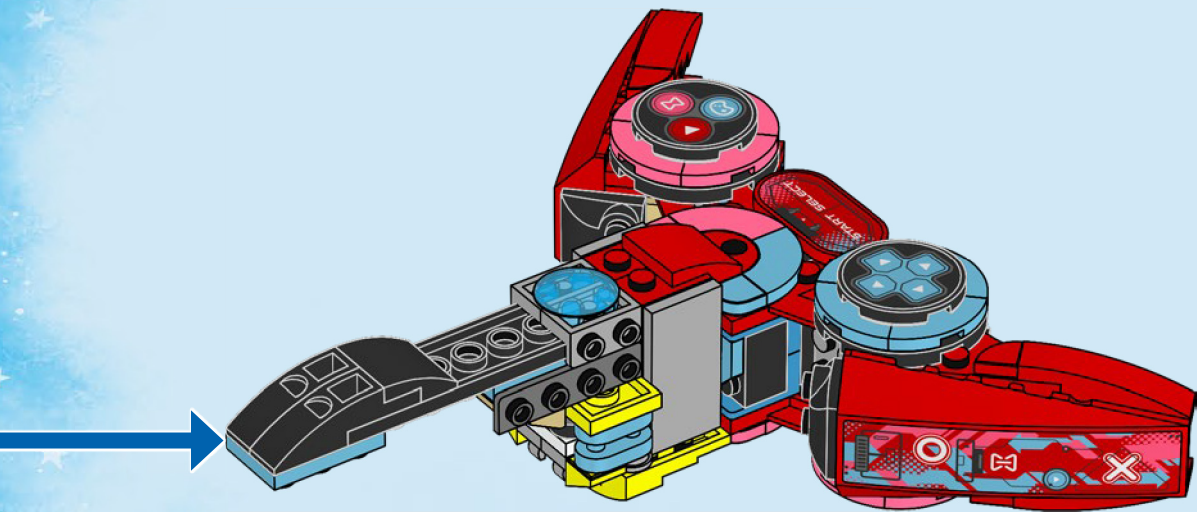



1x

84

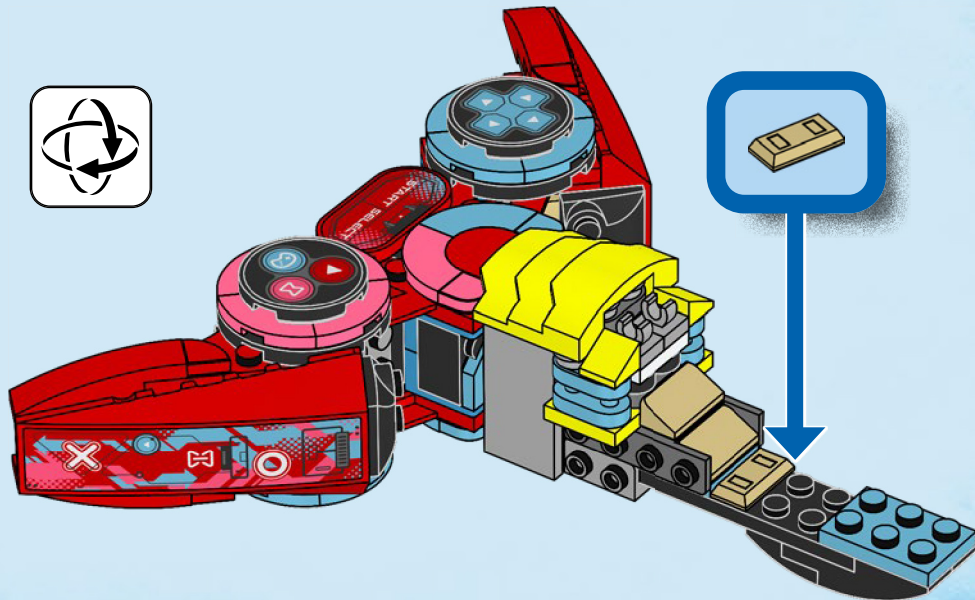



3x

85

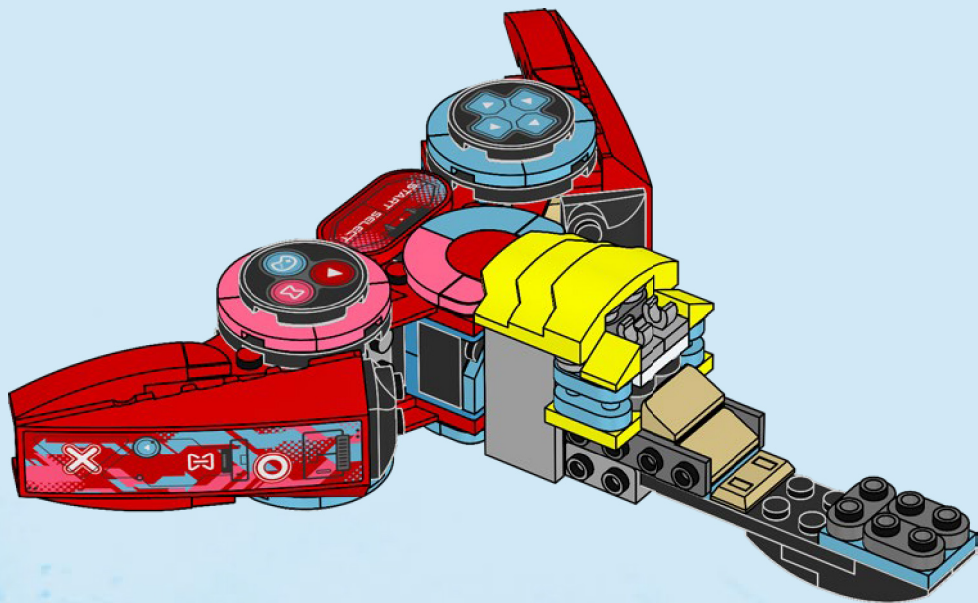



1x



1x

86

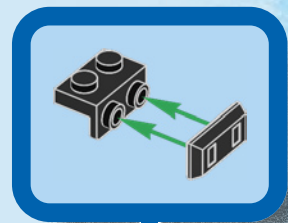
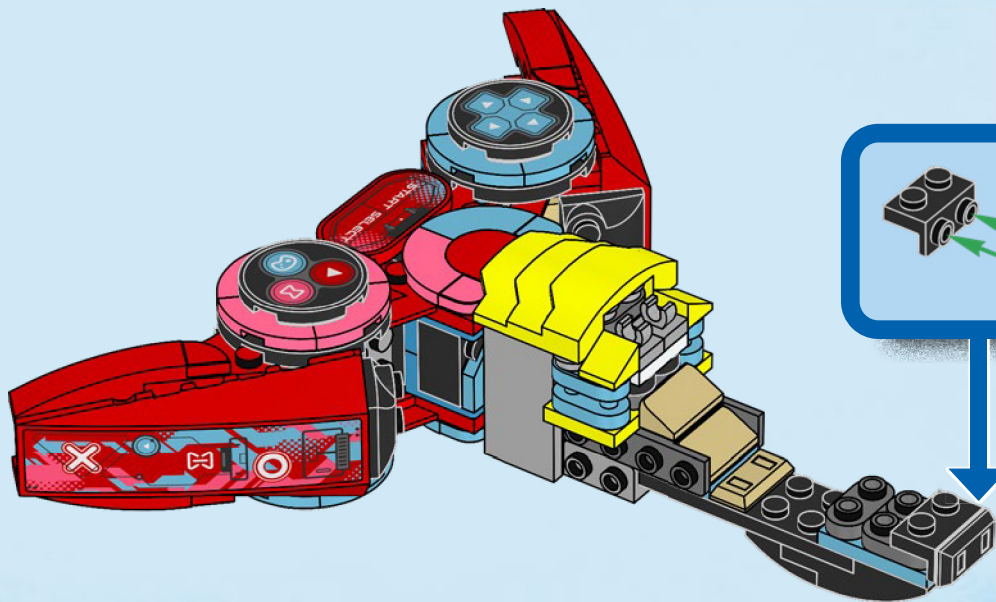



2x

87

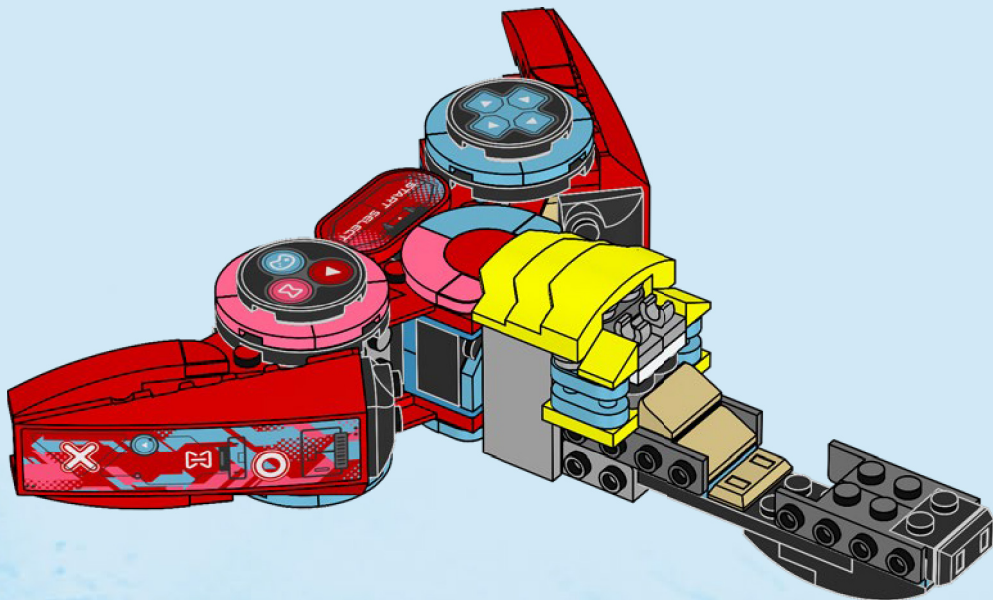

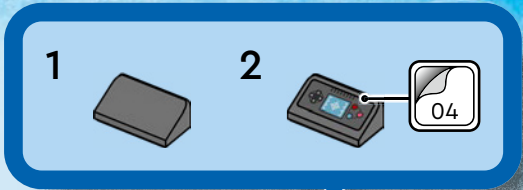
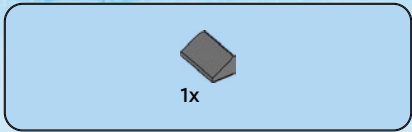

88

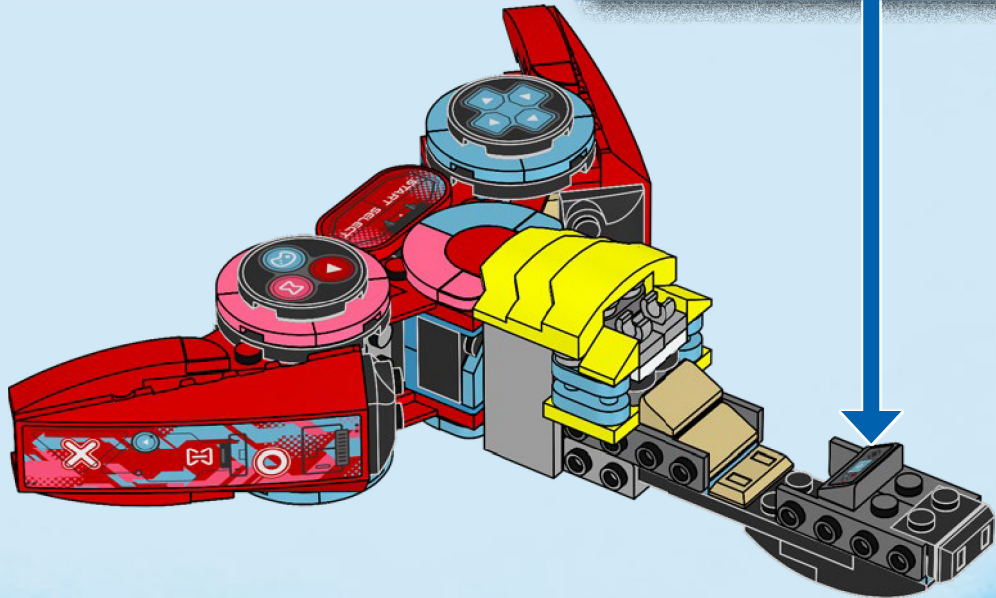



1x



1x

89

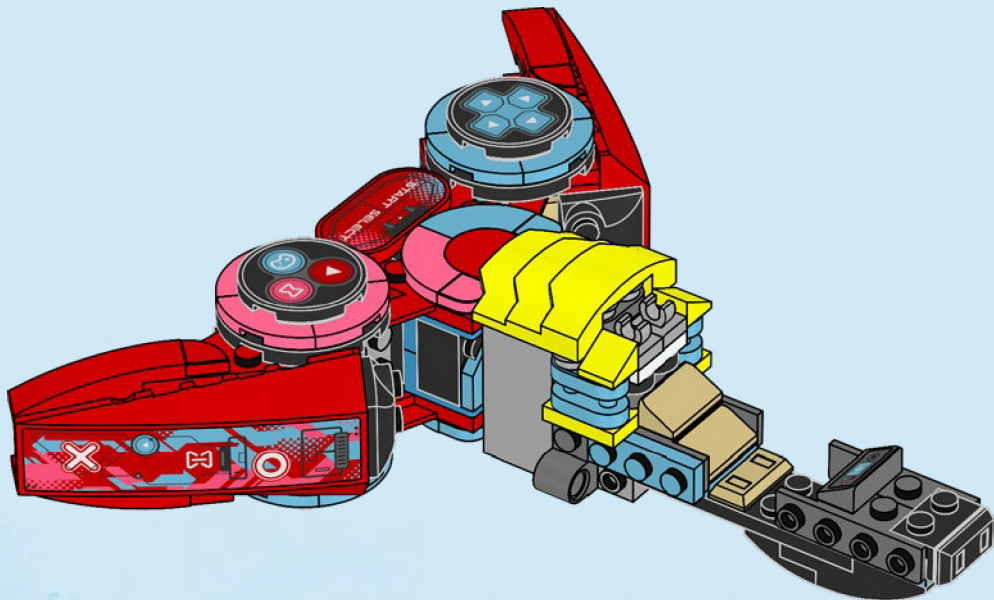

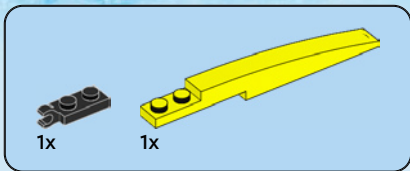

90

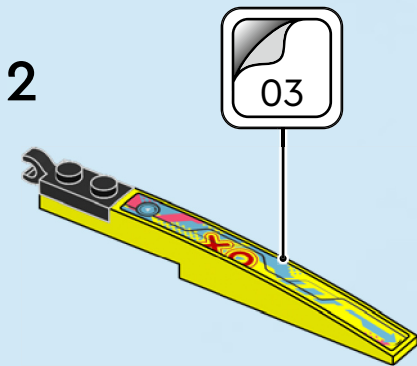
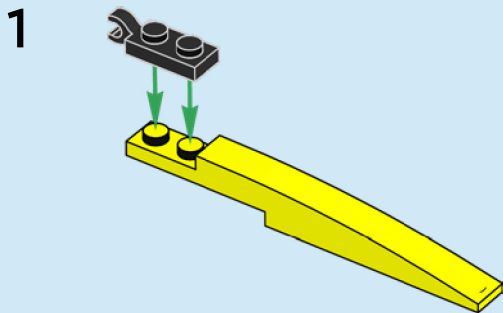

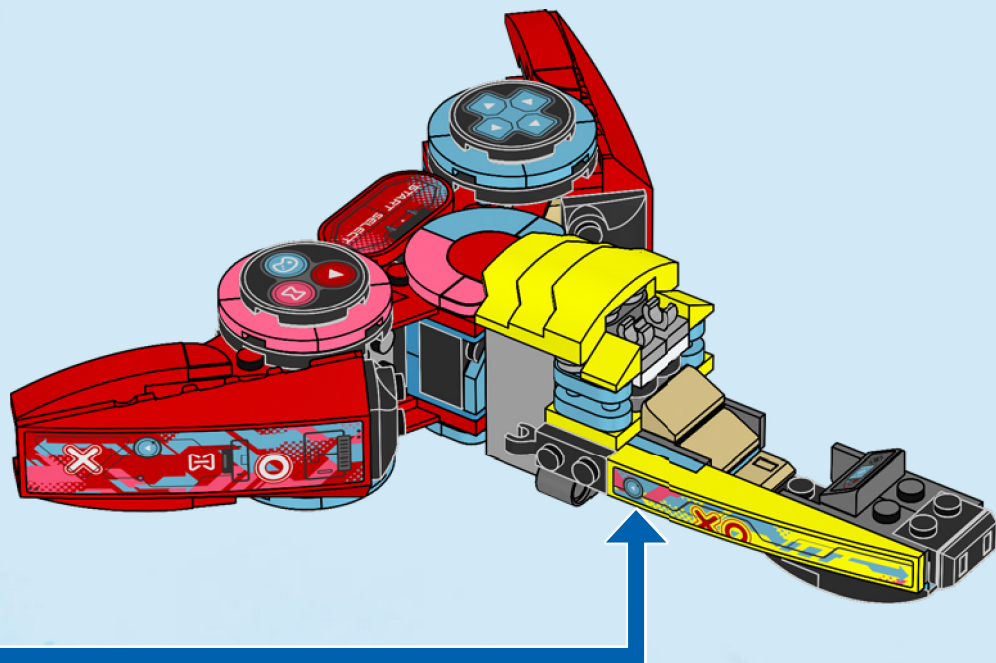



1x



1x

91

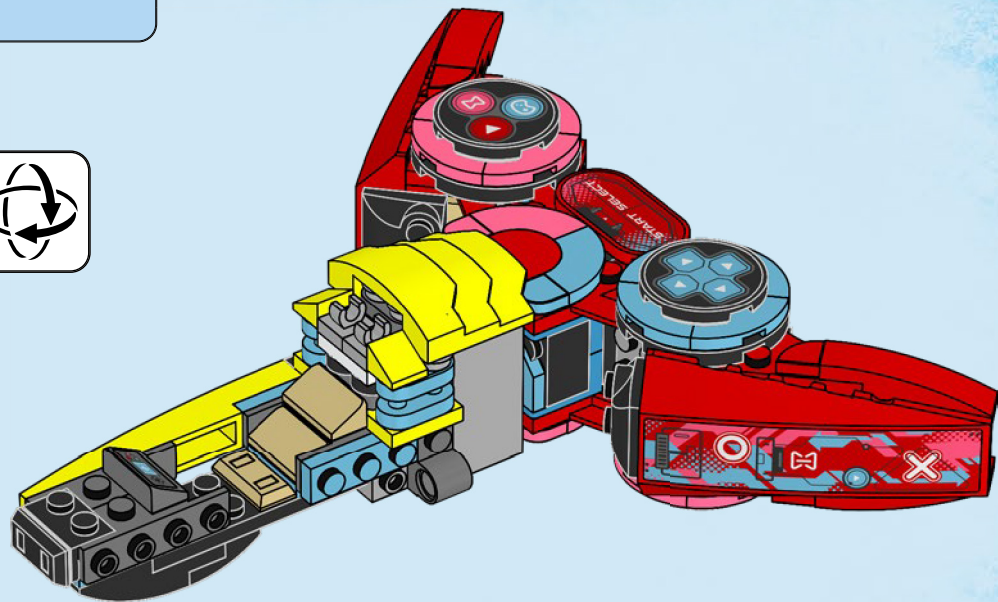
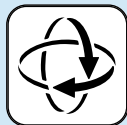

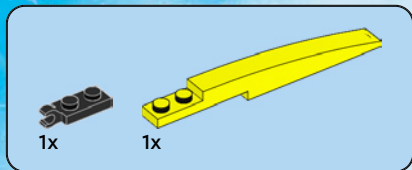

92

1

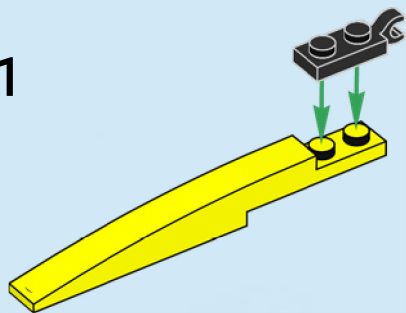

2

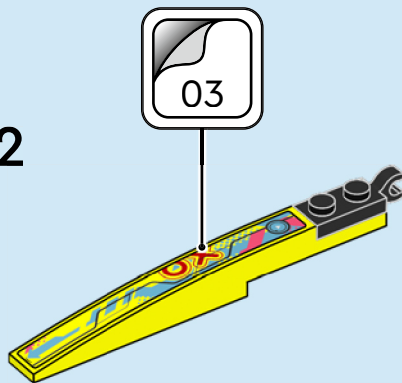

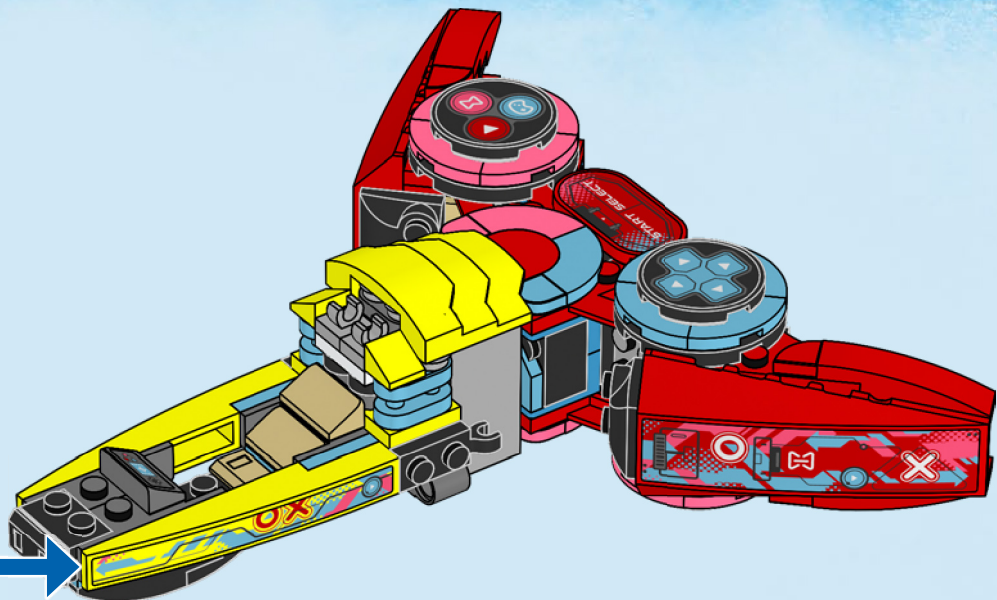

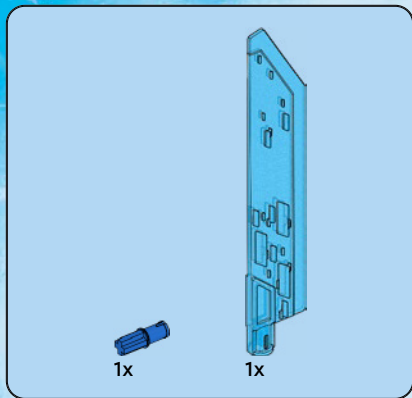

93

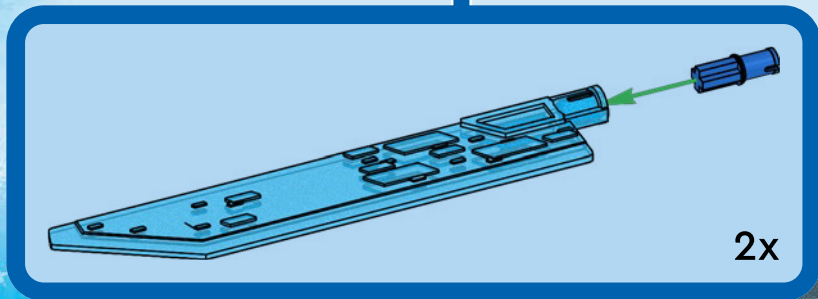
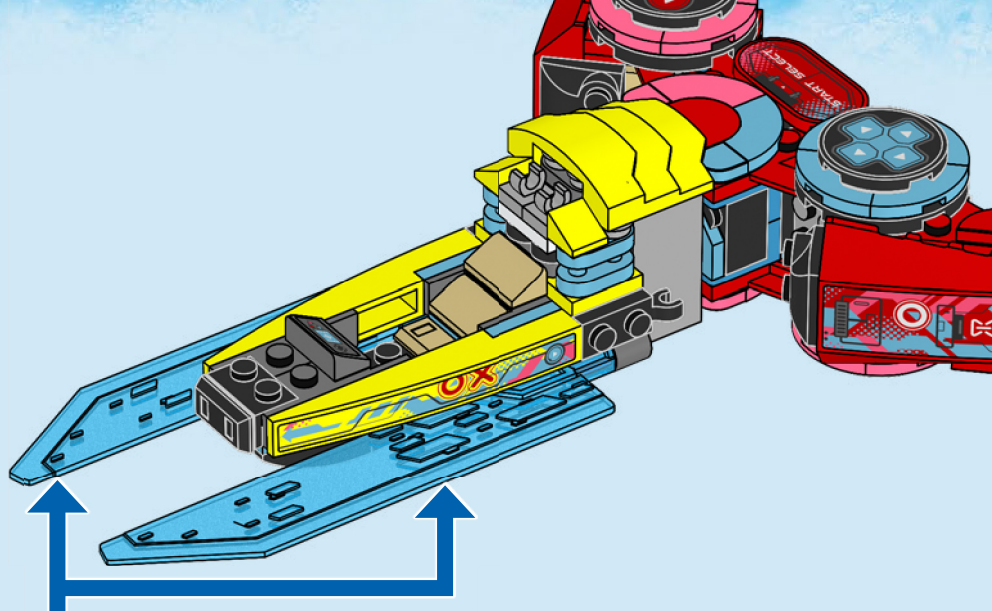

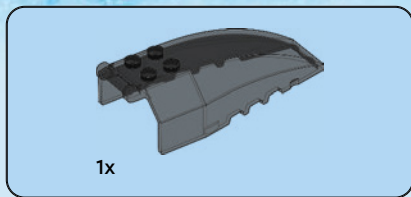

94

1

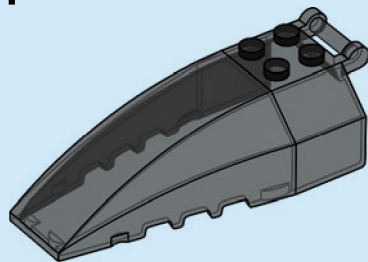

2

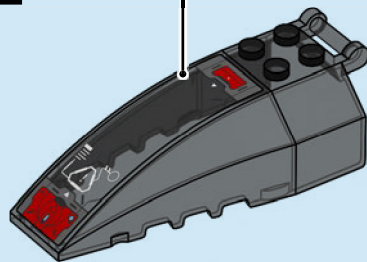

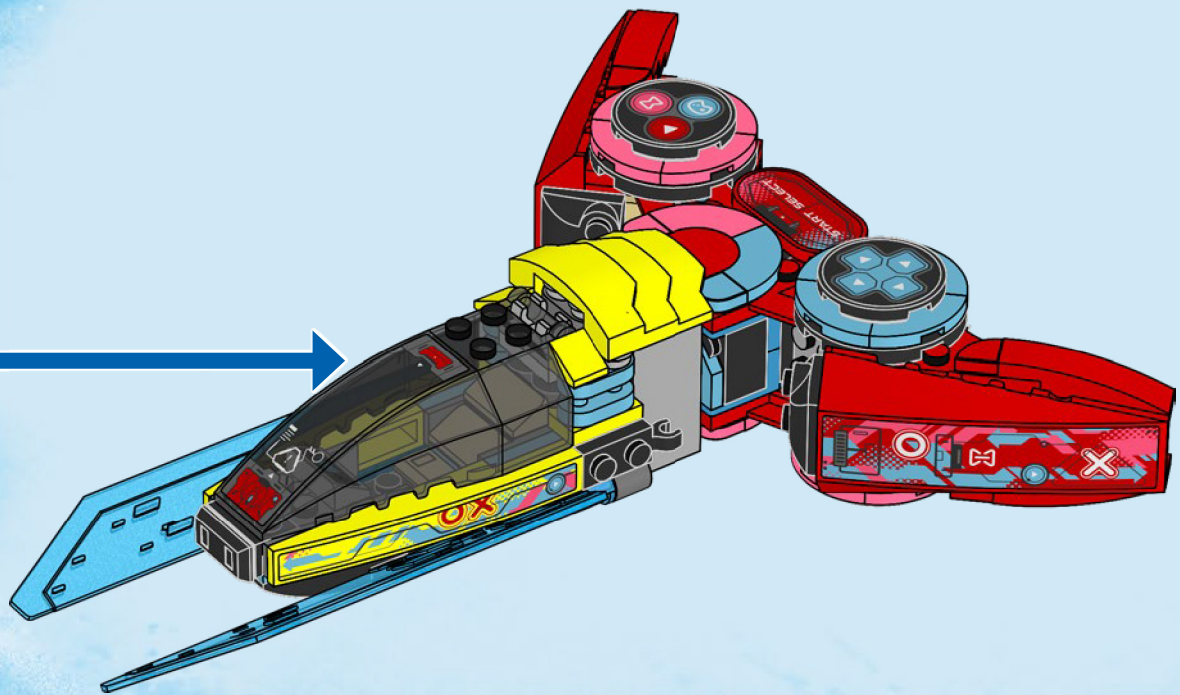



95

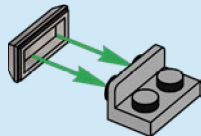

96



97

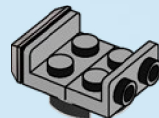

98

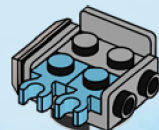



1x

99

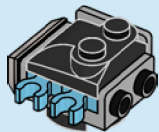

1x

100

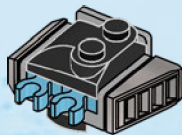

1x



1x



1x



101

1

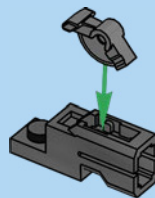

2

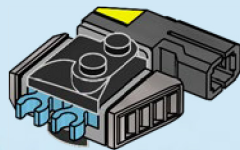
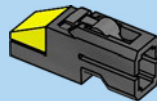

102

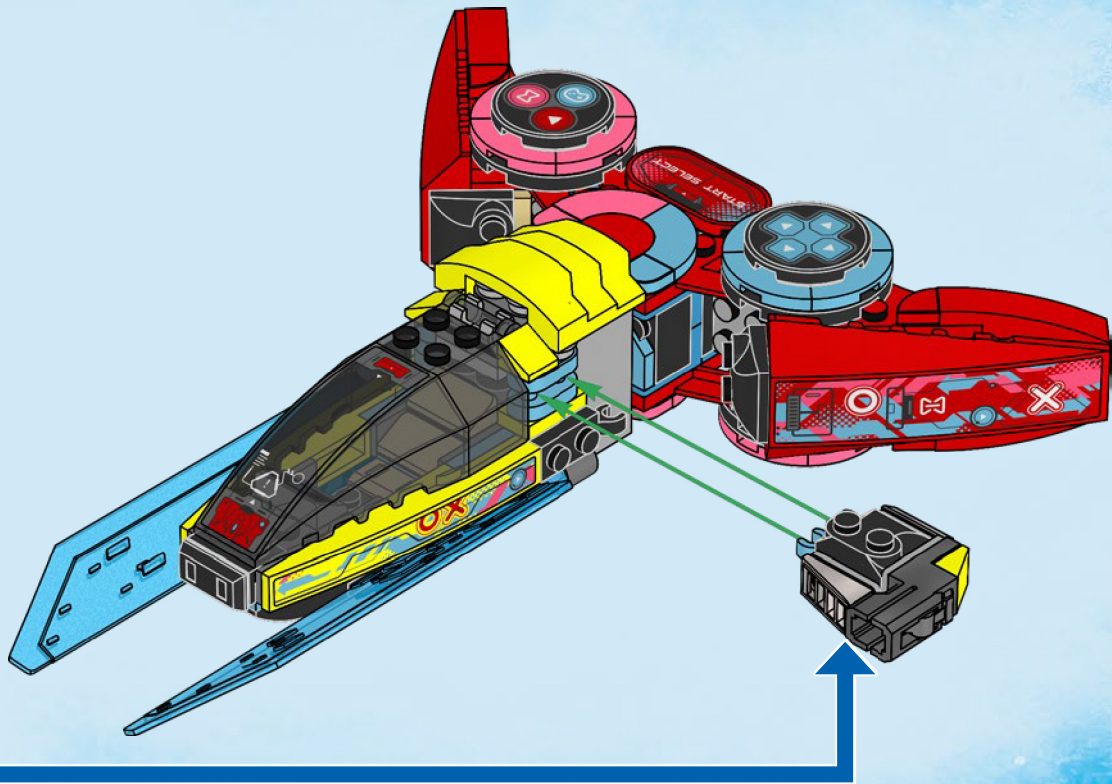



1x



1x

103

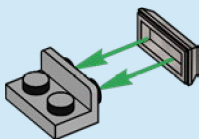

1x

104

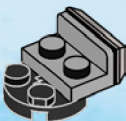

1x

105

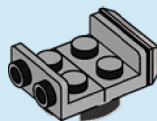

1x



2x

106

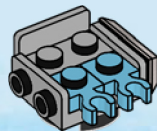



1x

107

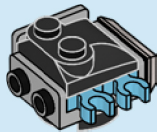

1x

108

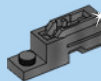
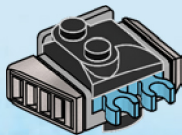

1x



1x



1x



109

1



2

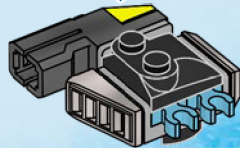
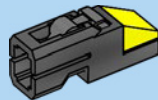

110

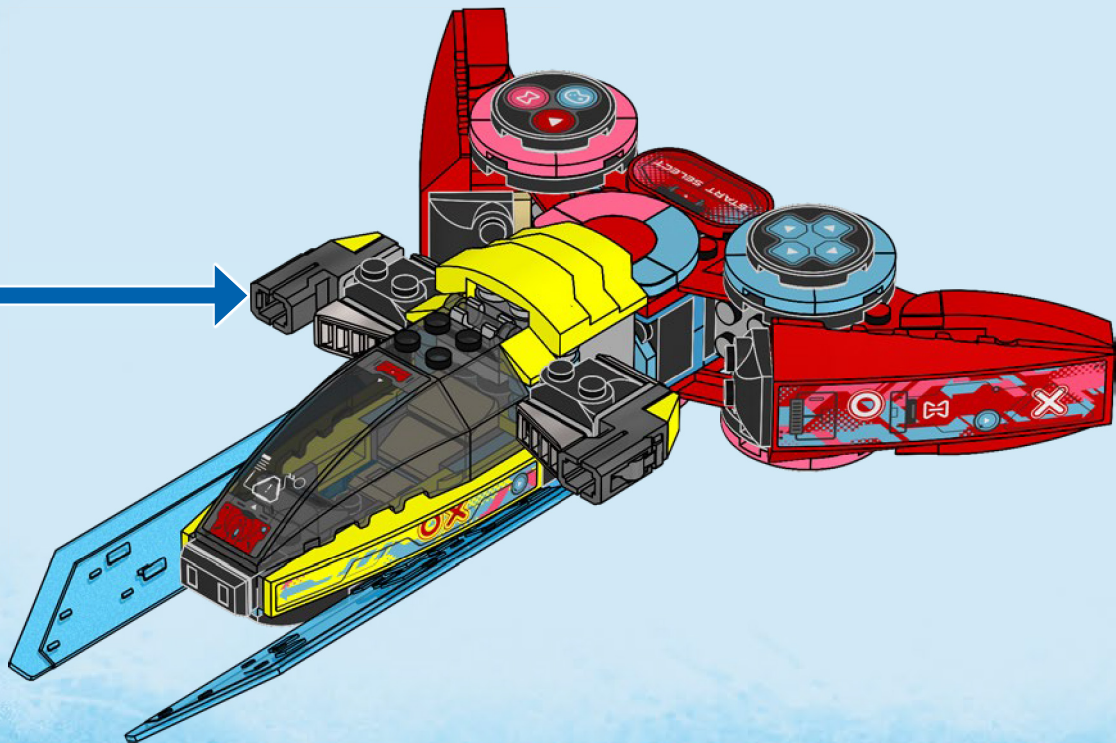



2x

111

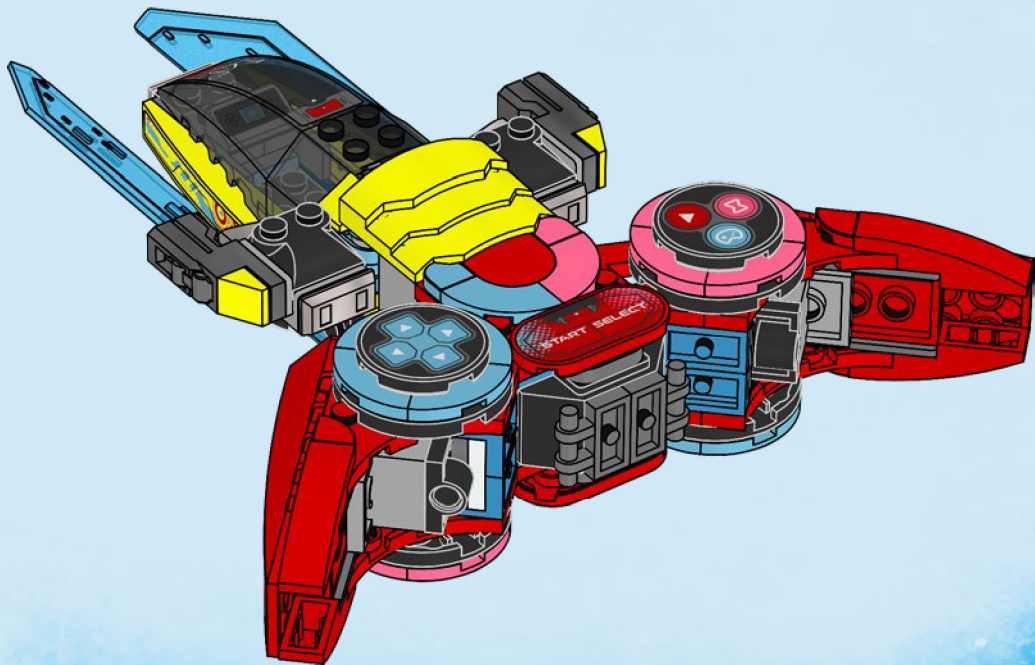



1x



2x

112

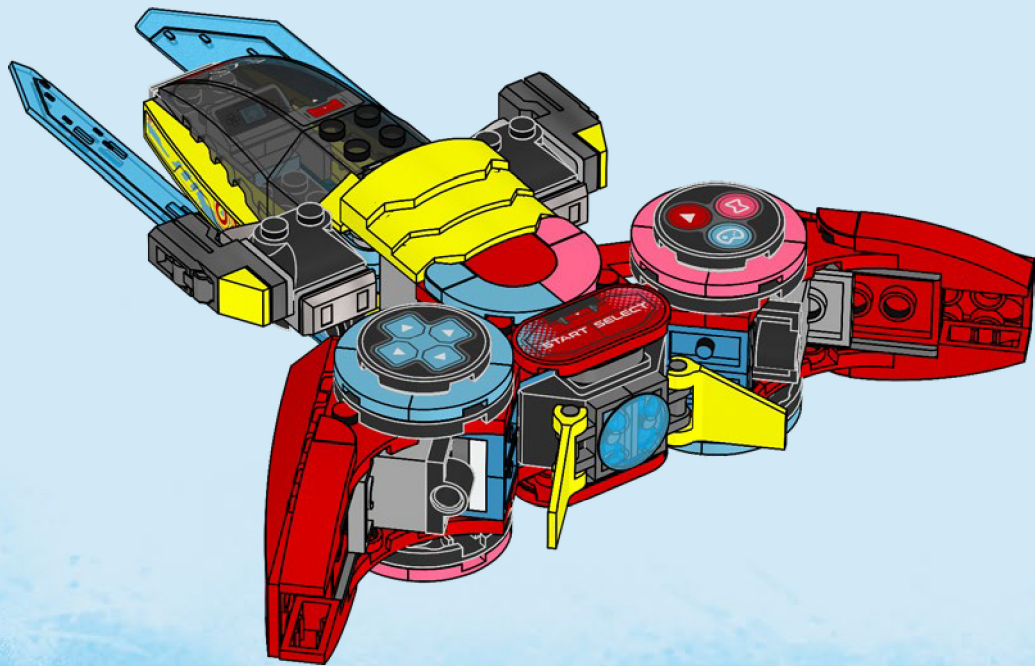

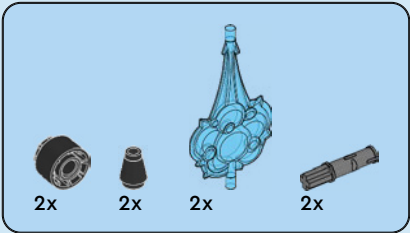

113

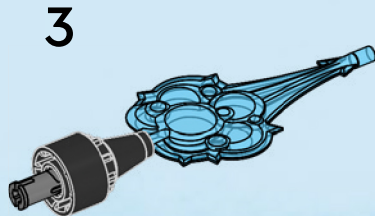
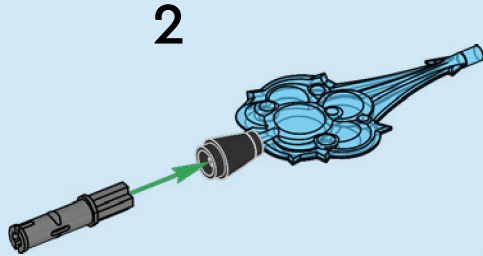
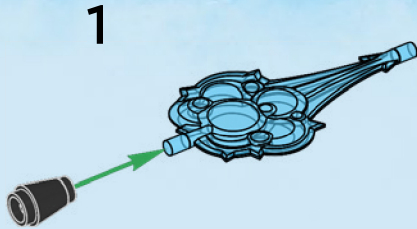

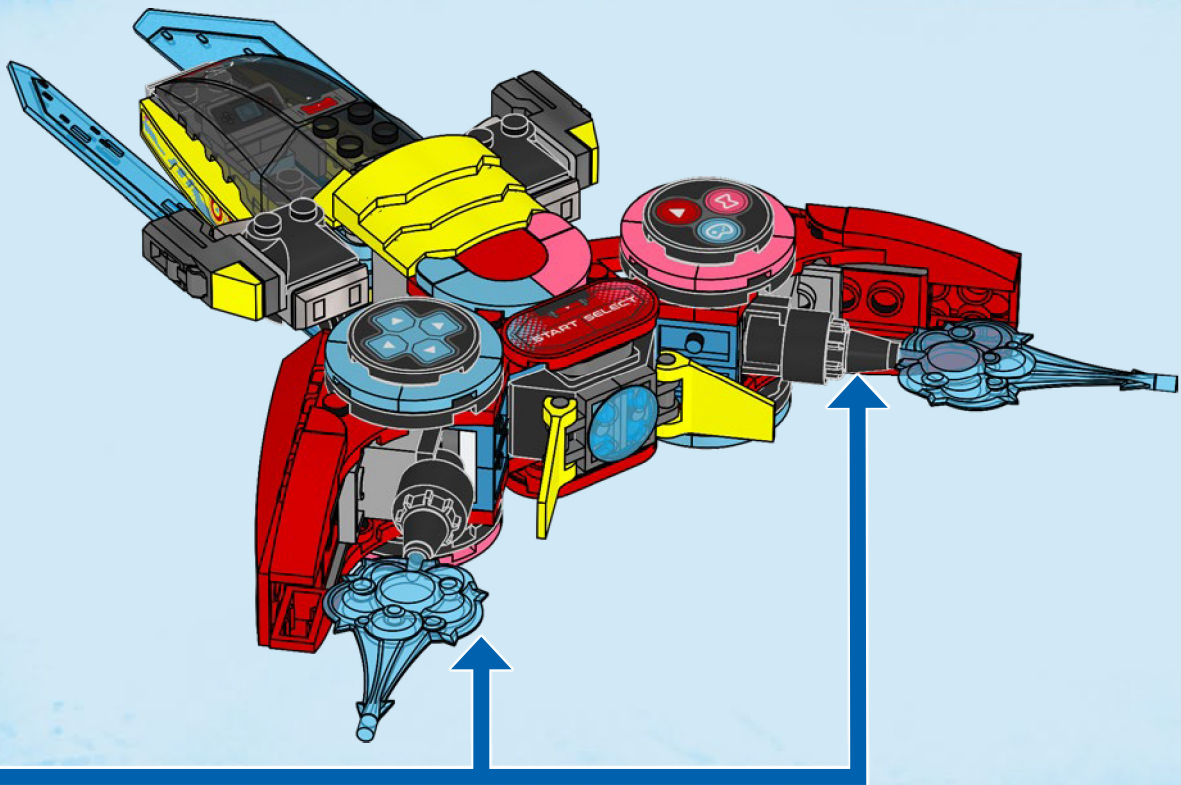

4x

114

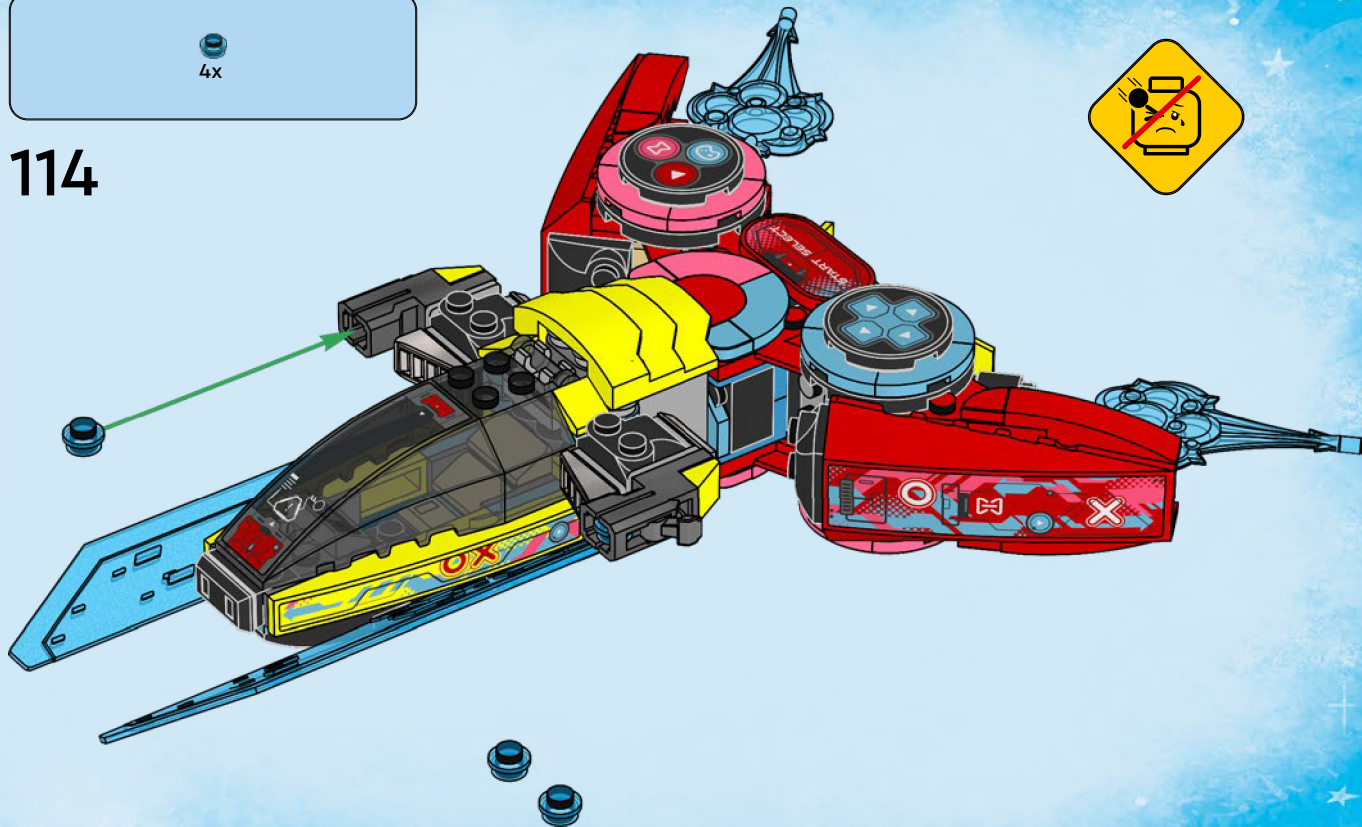

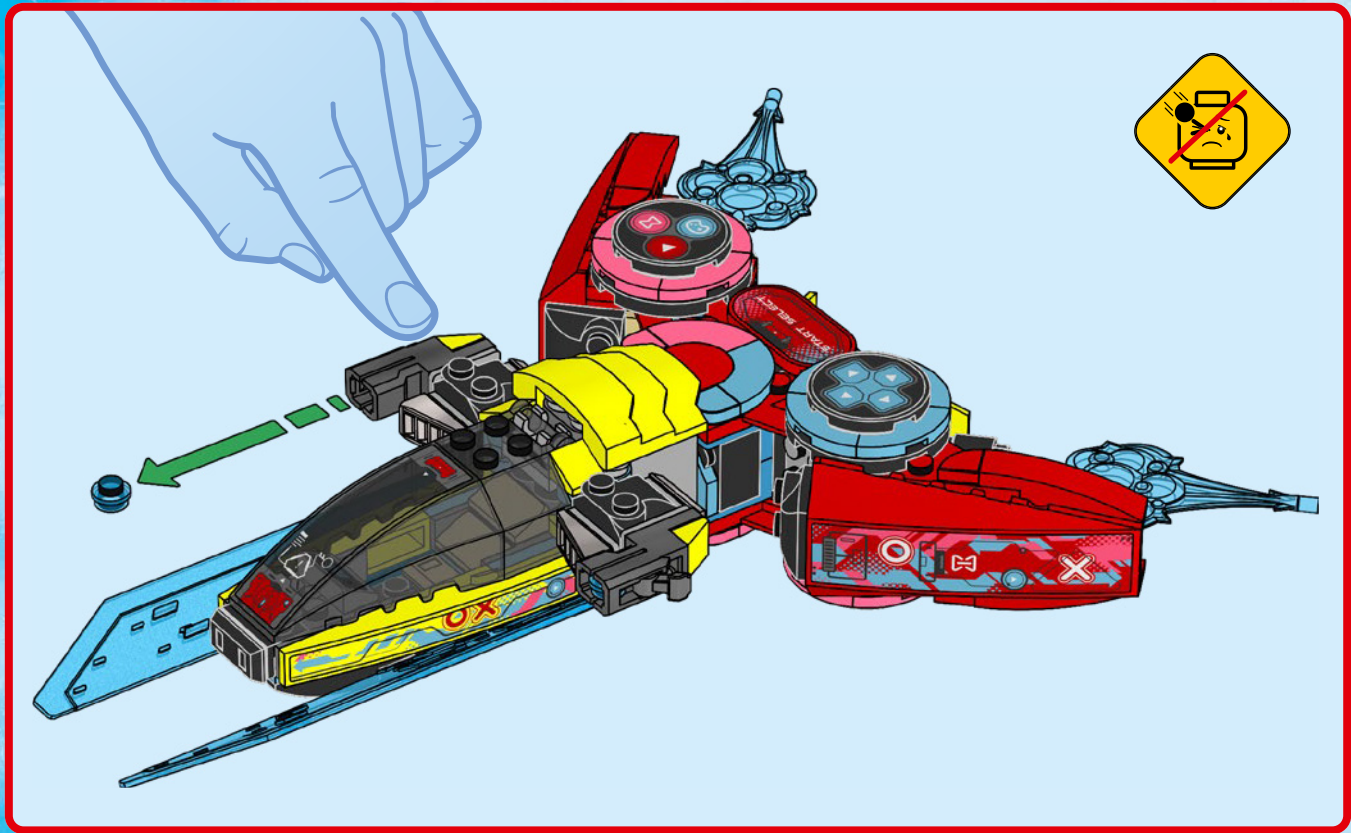



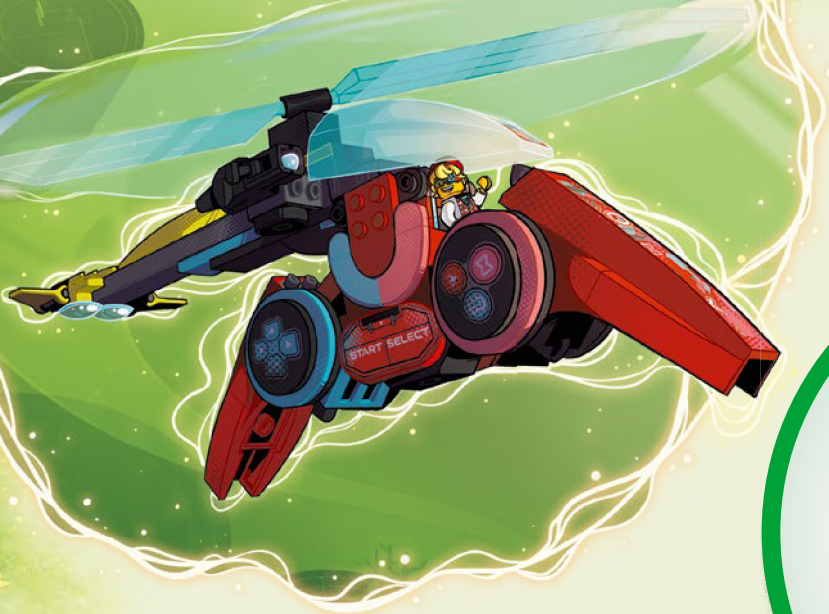



1x

58

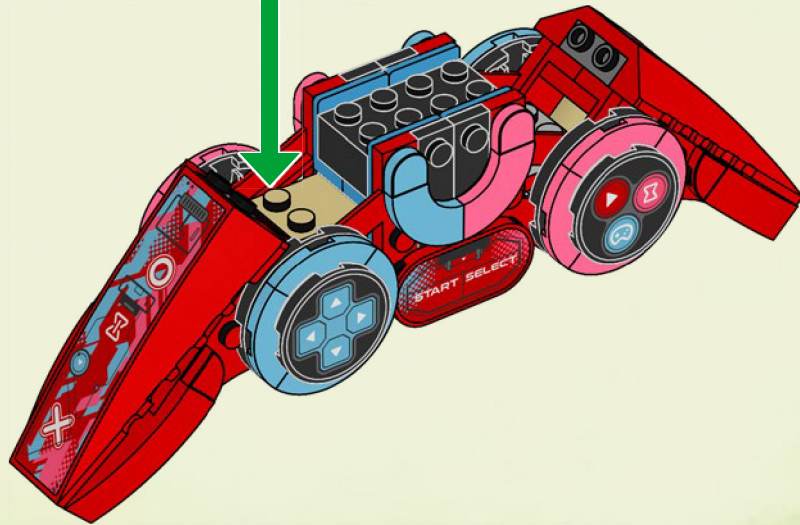



1x

59

1



2

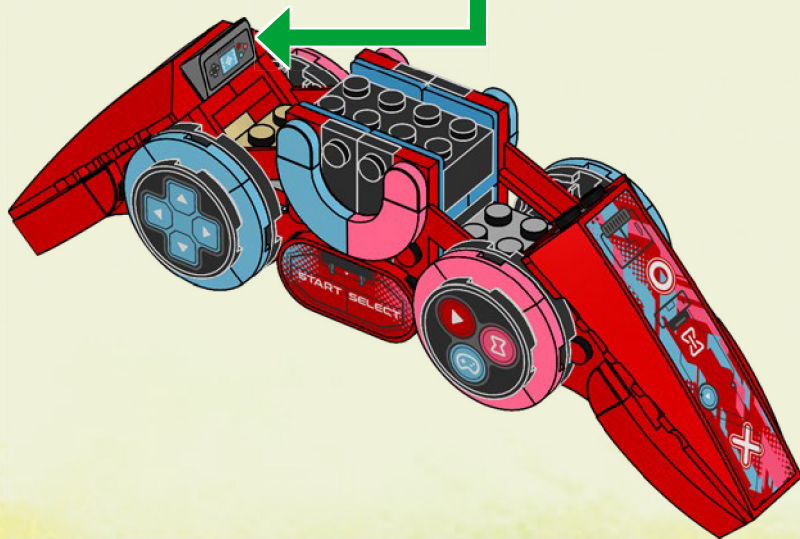
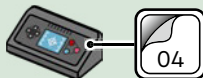

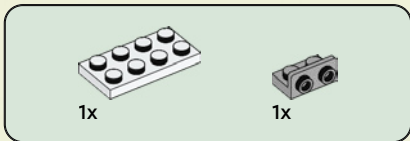
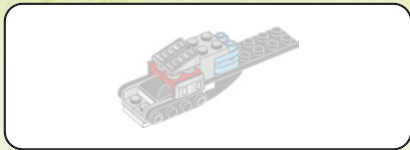

60

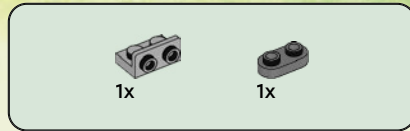
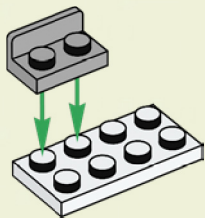

61

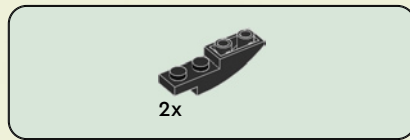
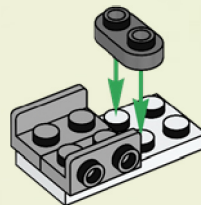

62

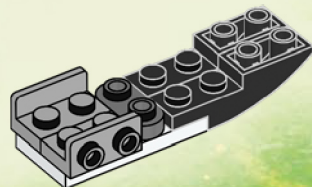



1x

63

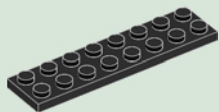
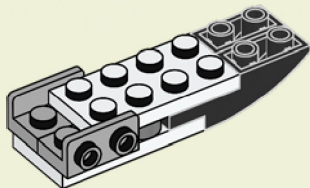

1x



1x

64

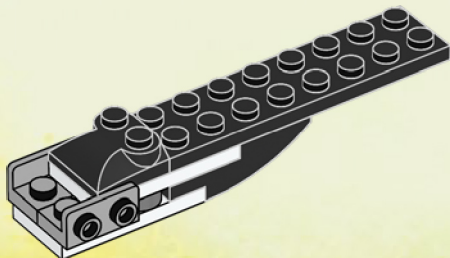

2x

65

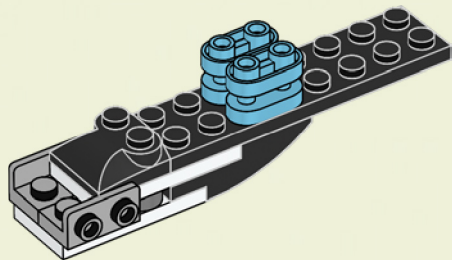

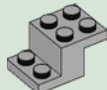

1x

66

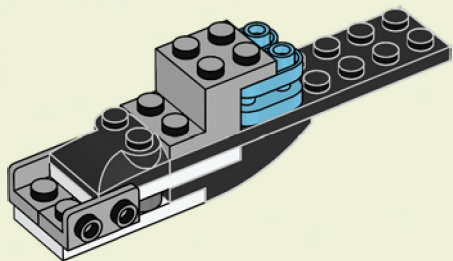

2x

67

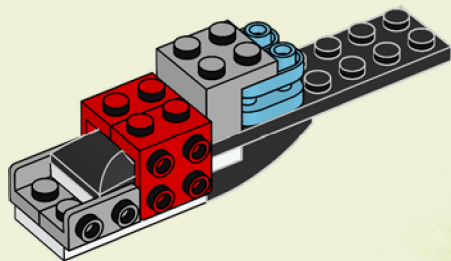



2x

68

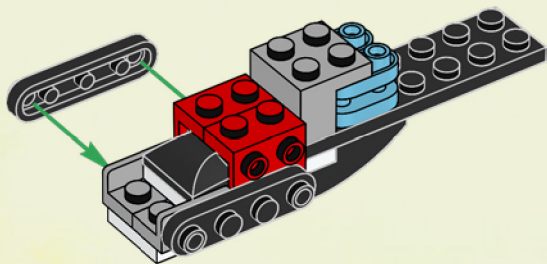

2x

69

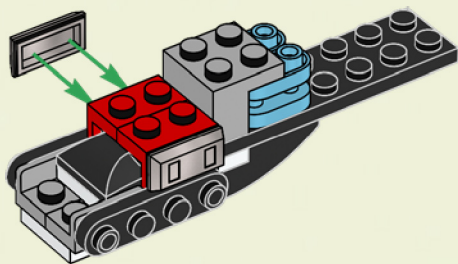



4x

70

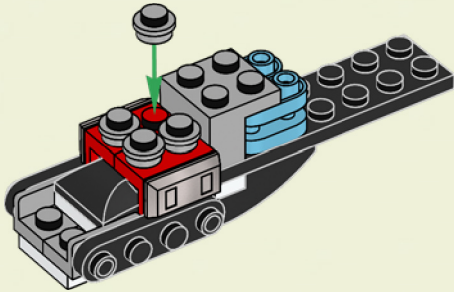

2x

71

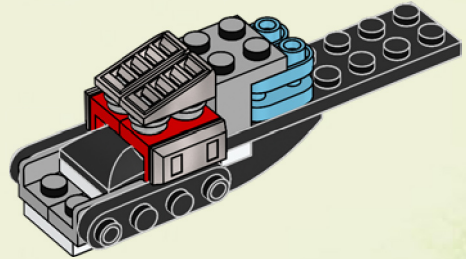

72

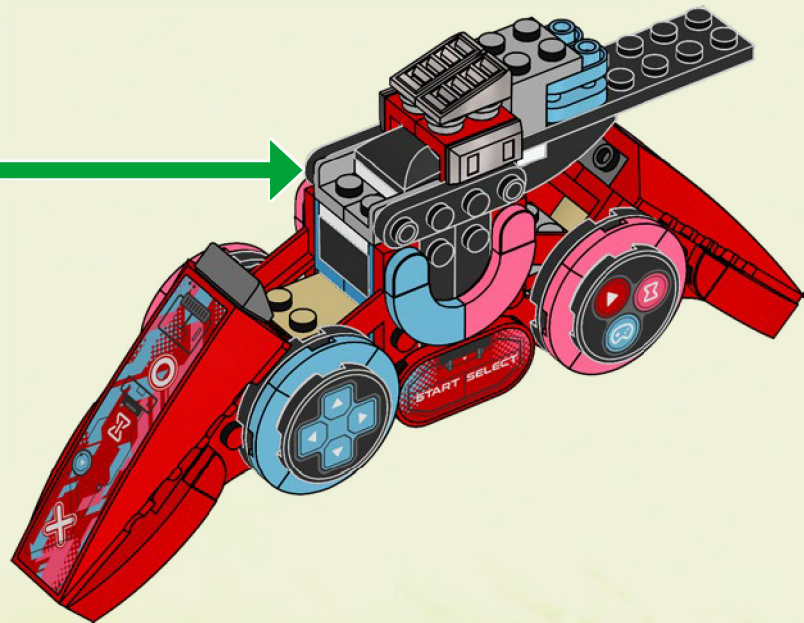



2x

73

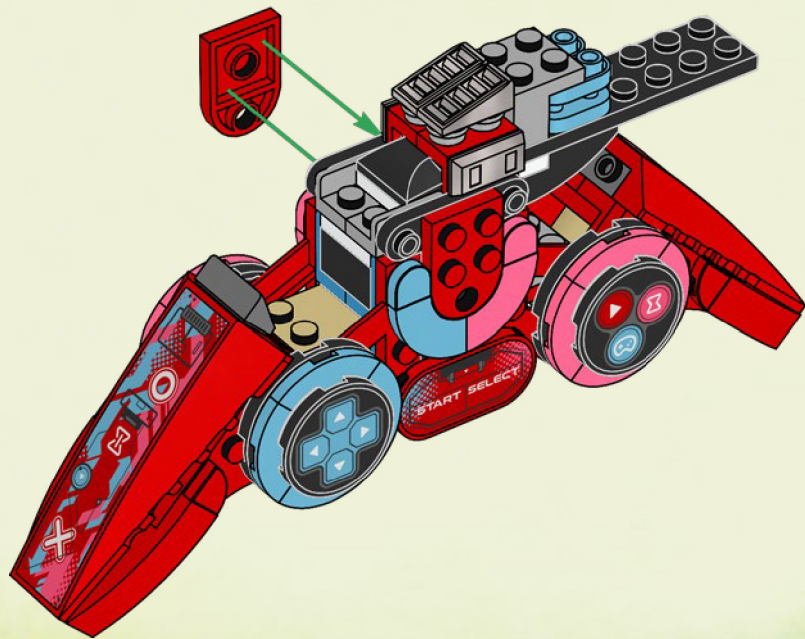

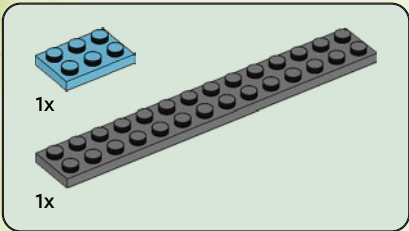
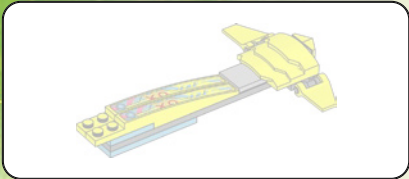

74

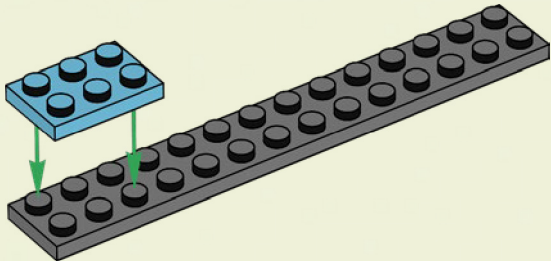

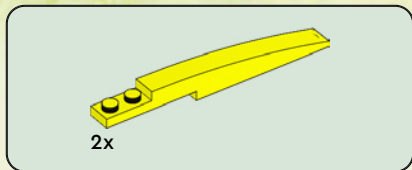

75

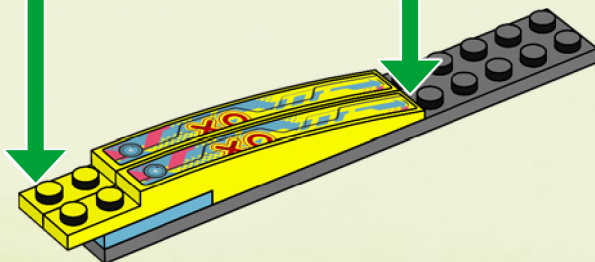
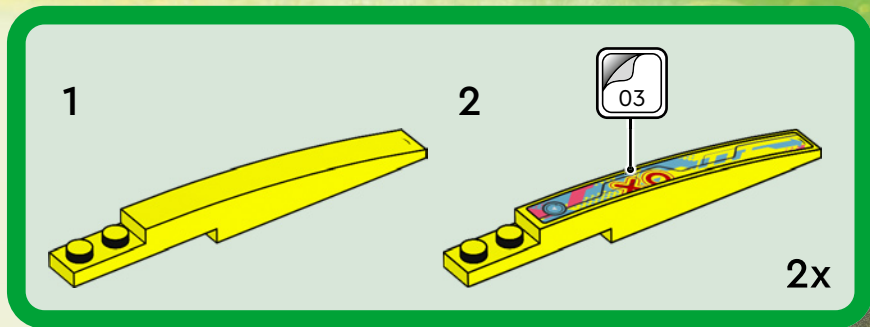

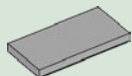

1x

76

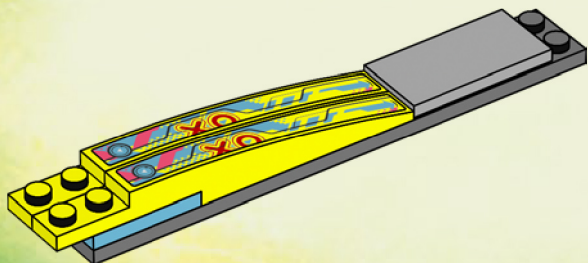

1x



1x



2x

77

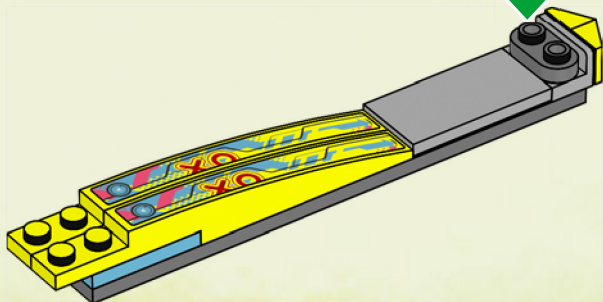
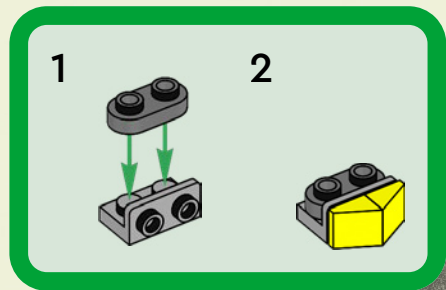

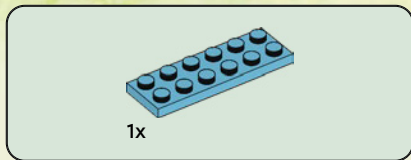

78

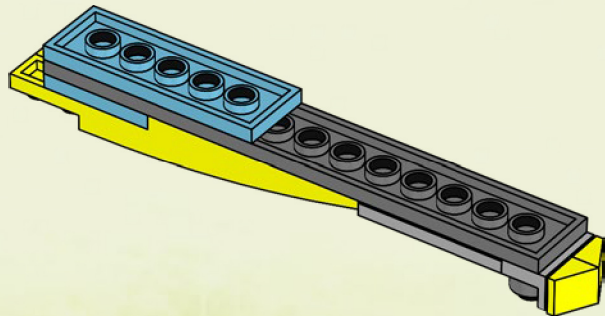

79

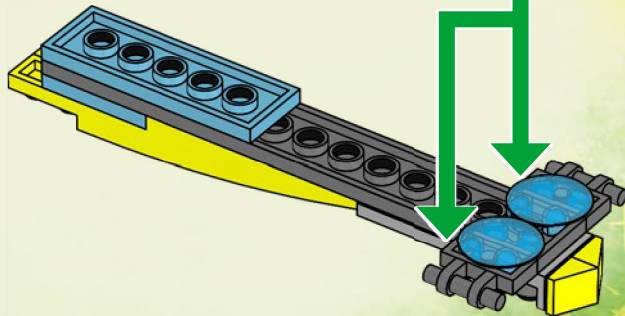
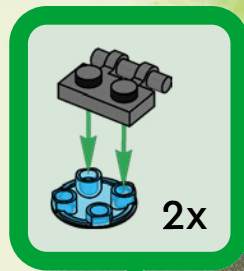

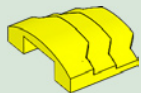

1x

80

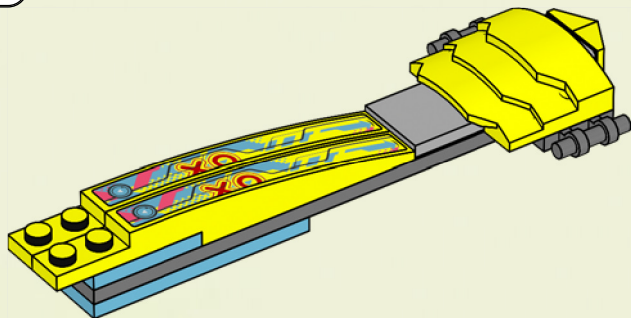



2x

81

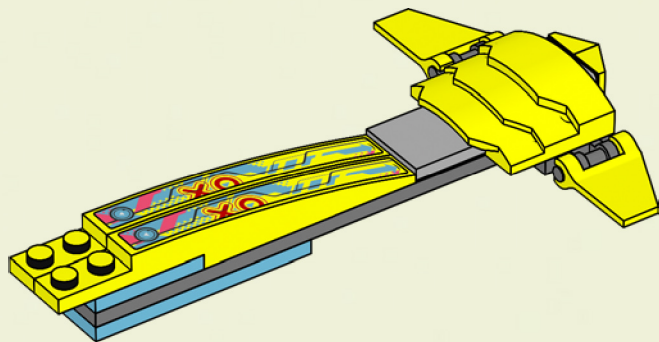

82

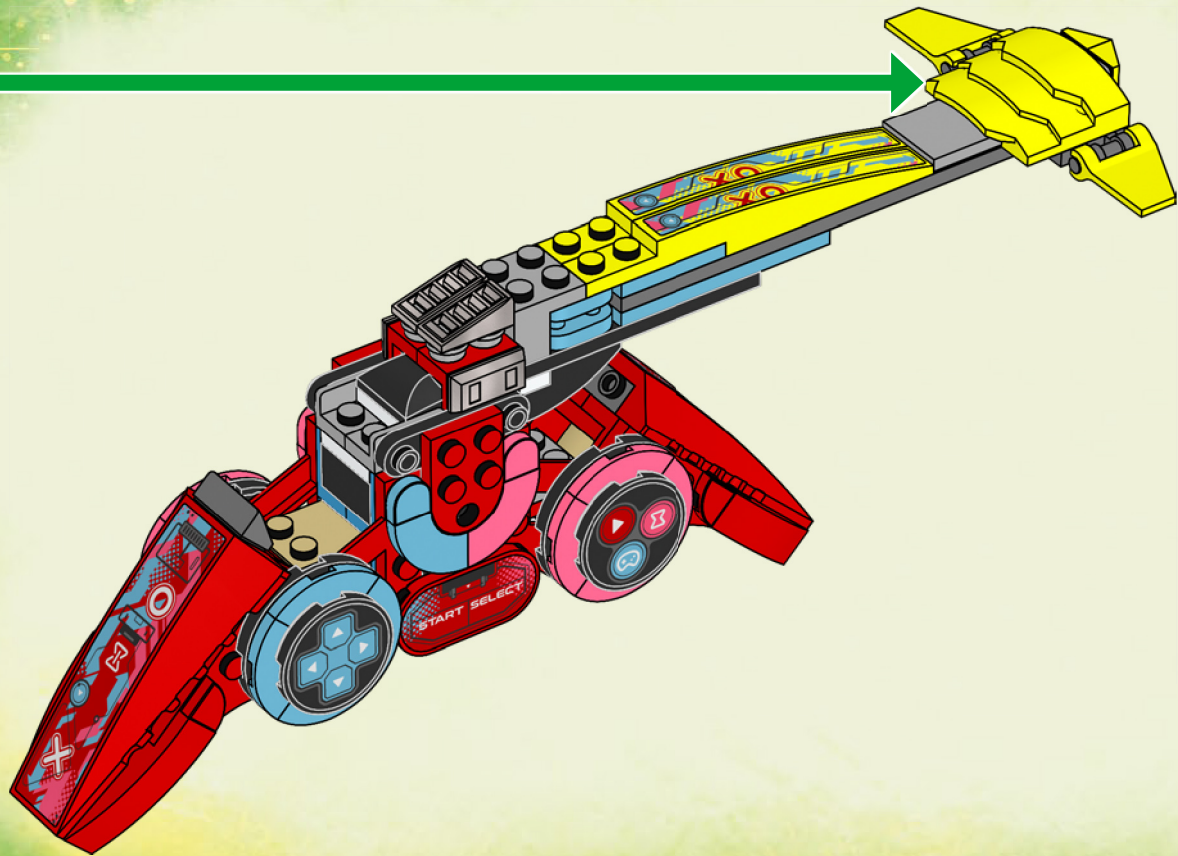

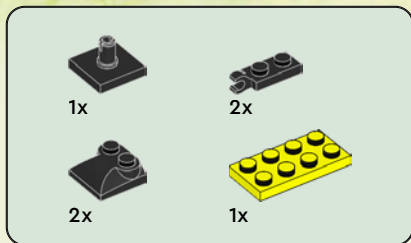

83

1

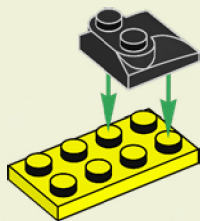

2

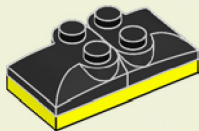

3

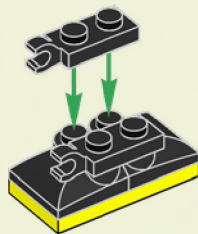

4

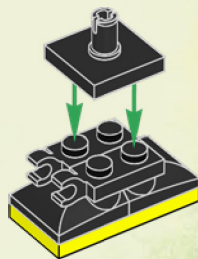

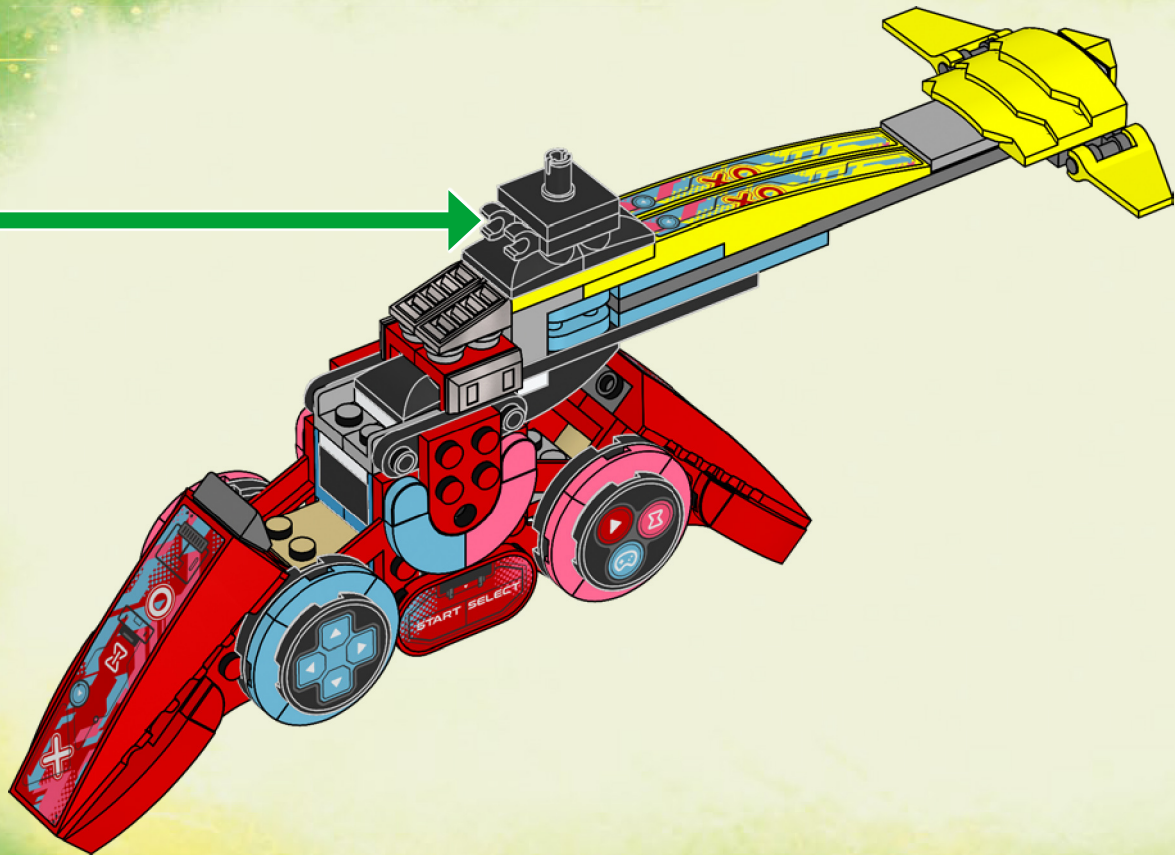



1x



1x

84

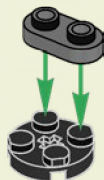

1x

85



1x



2x

86

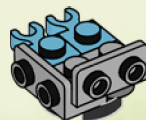



87

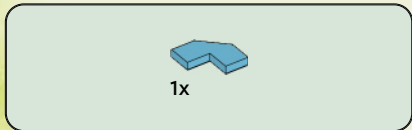
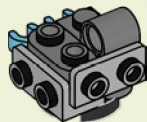

88

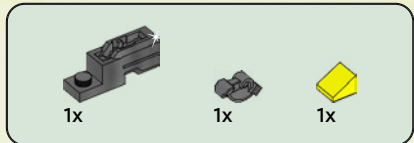
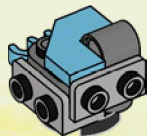

89

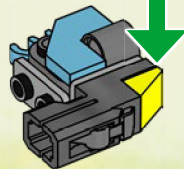
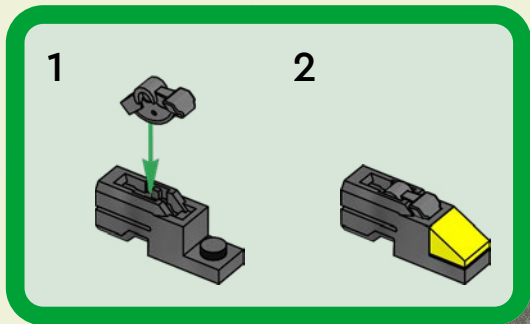

90

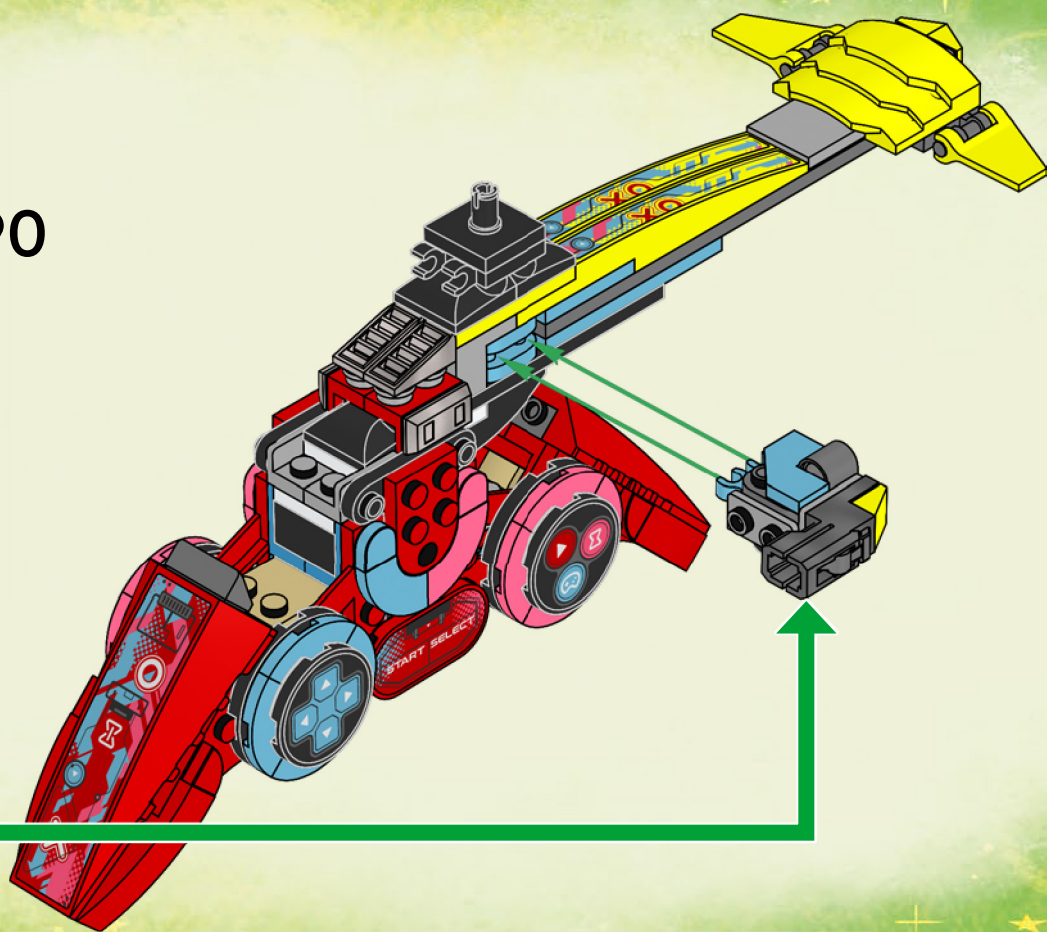

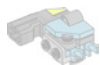

1x



1x

91



1x

92



1x



2x

93

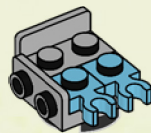



94

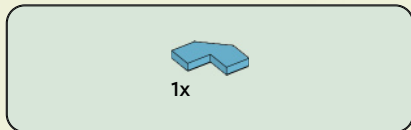
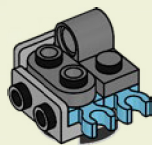

95

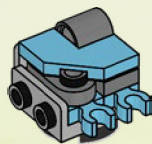

96

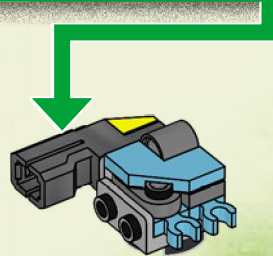
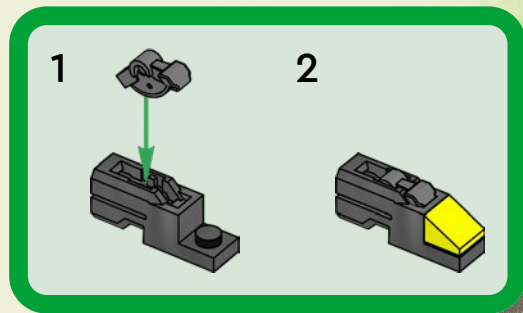

97

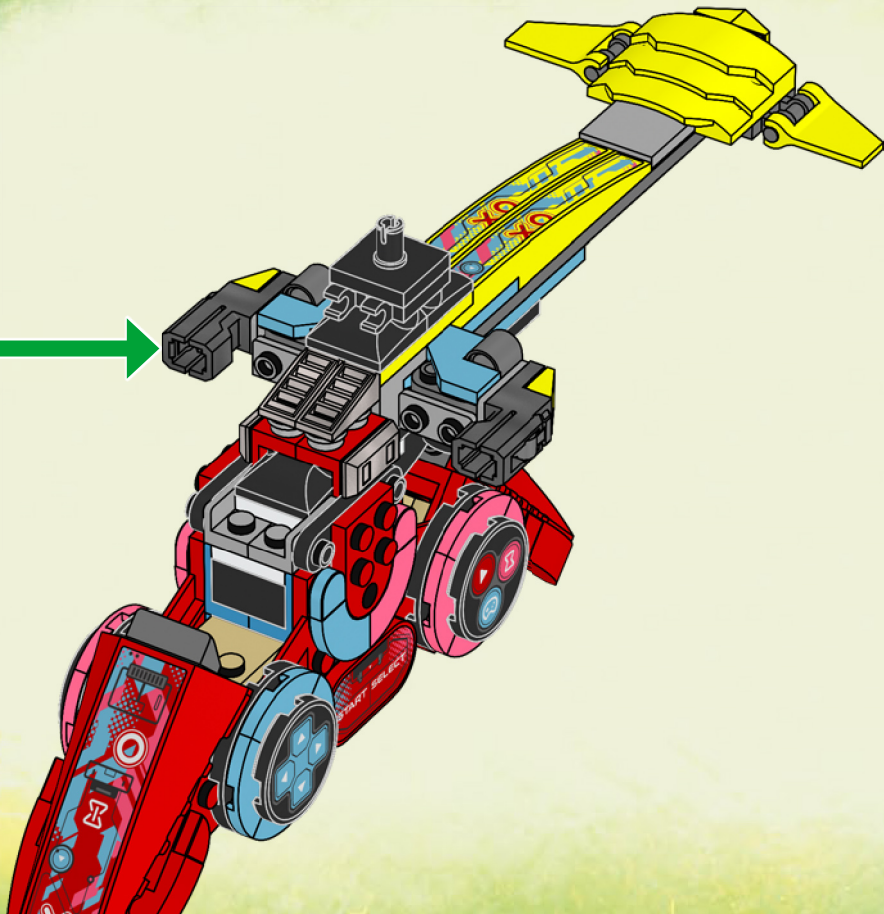

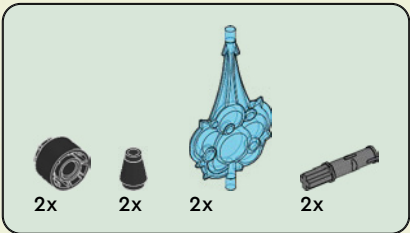
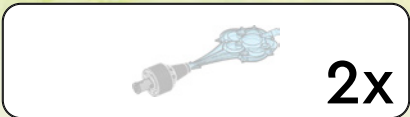

98

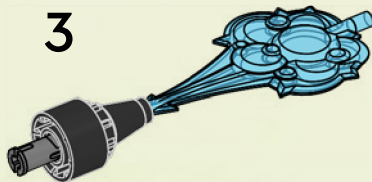
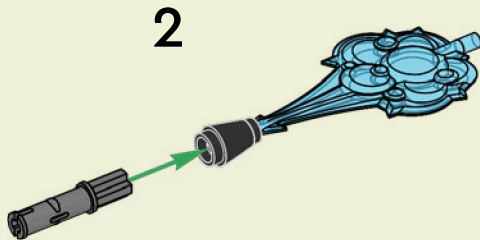
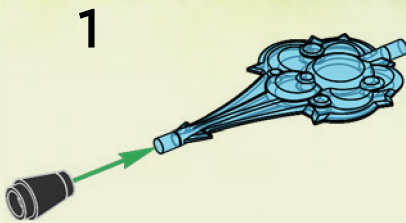

2x

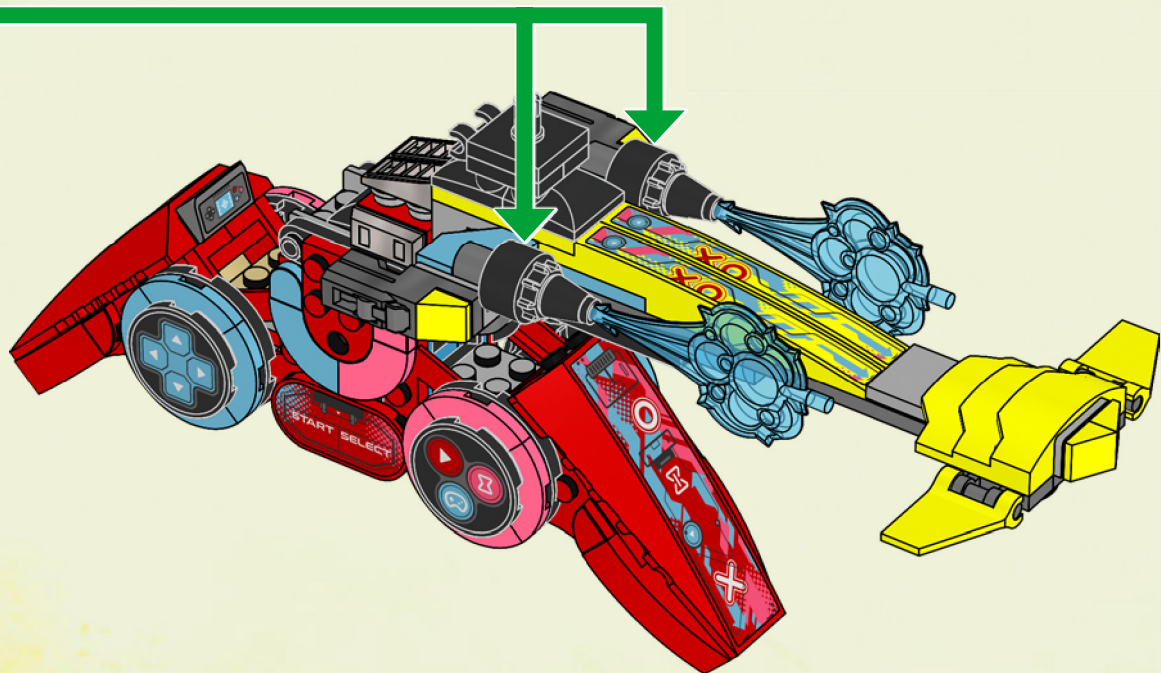

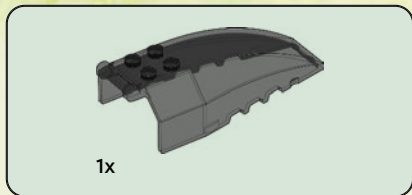

99

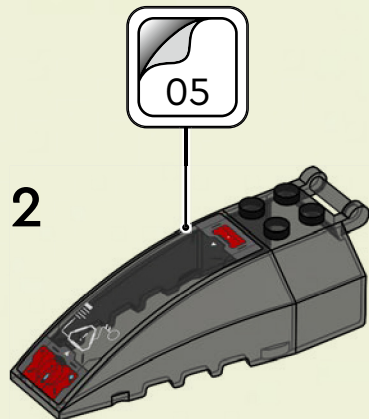
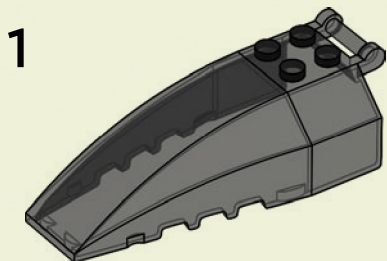

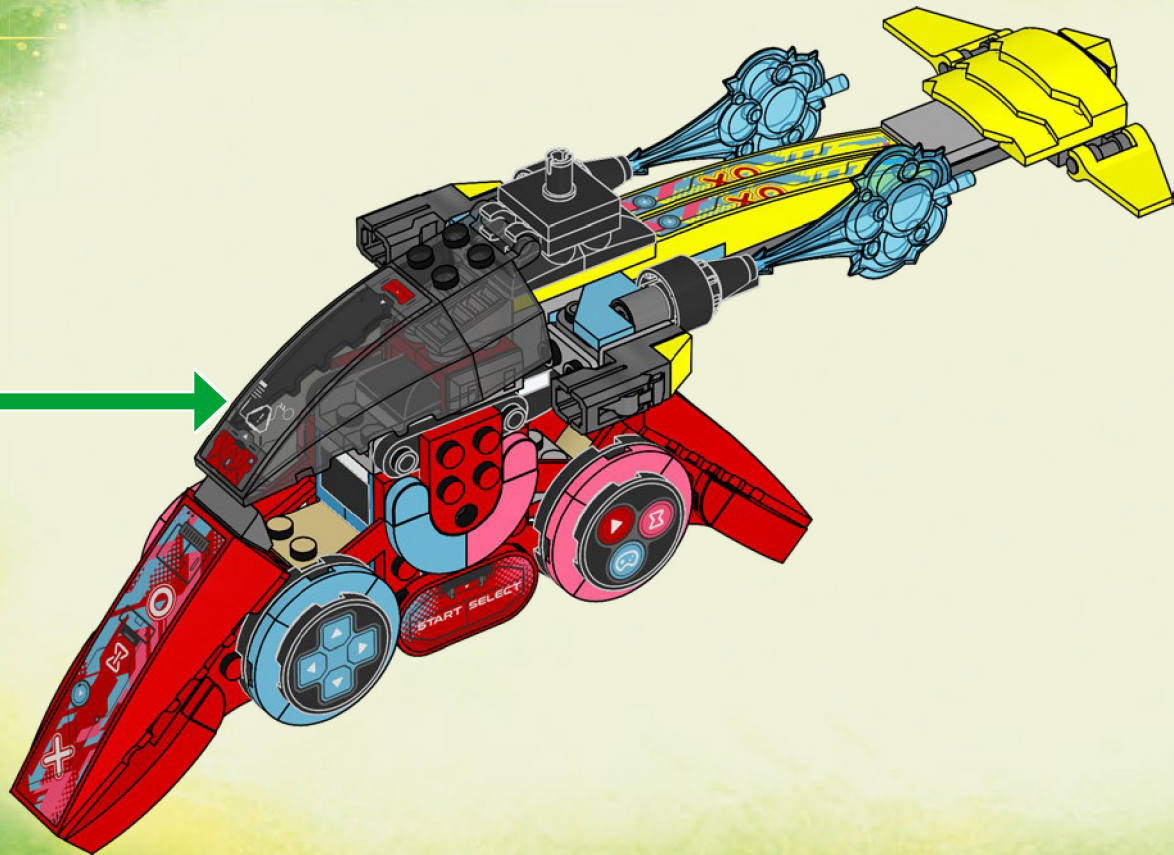

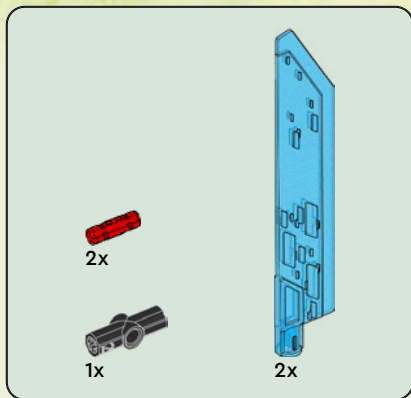

100

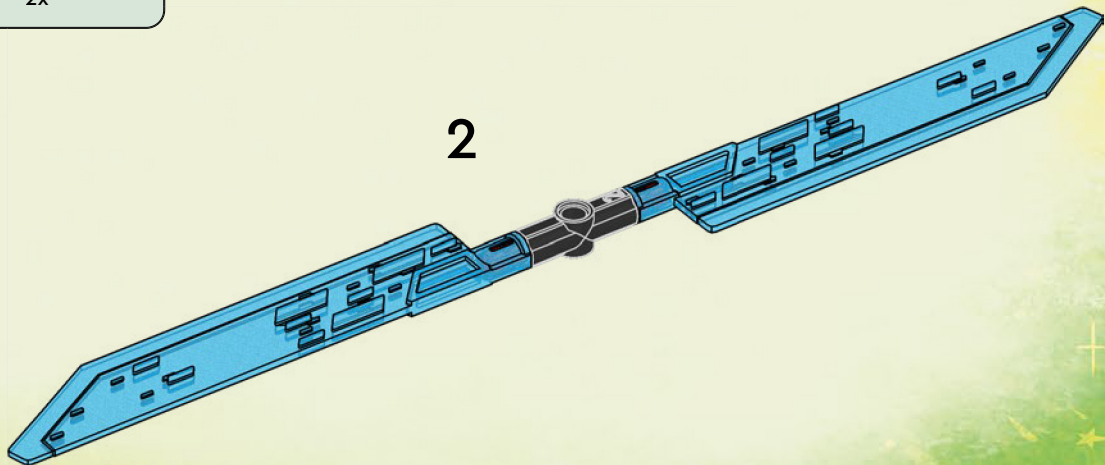
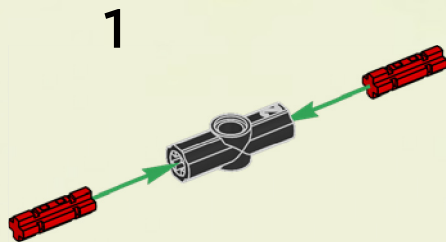

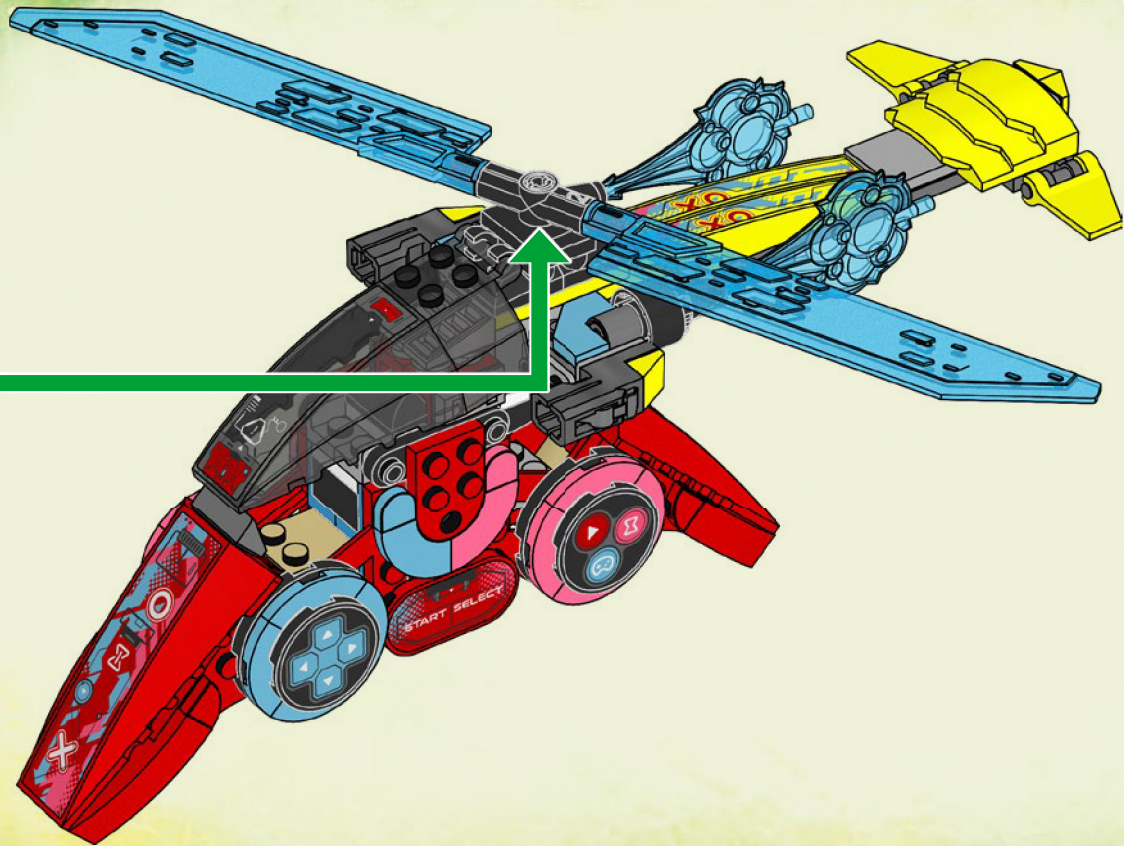



4x

101

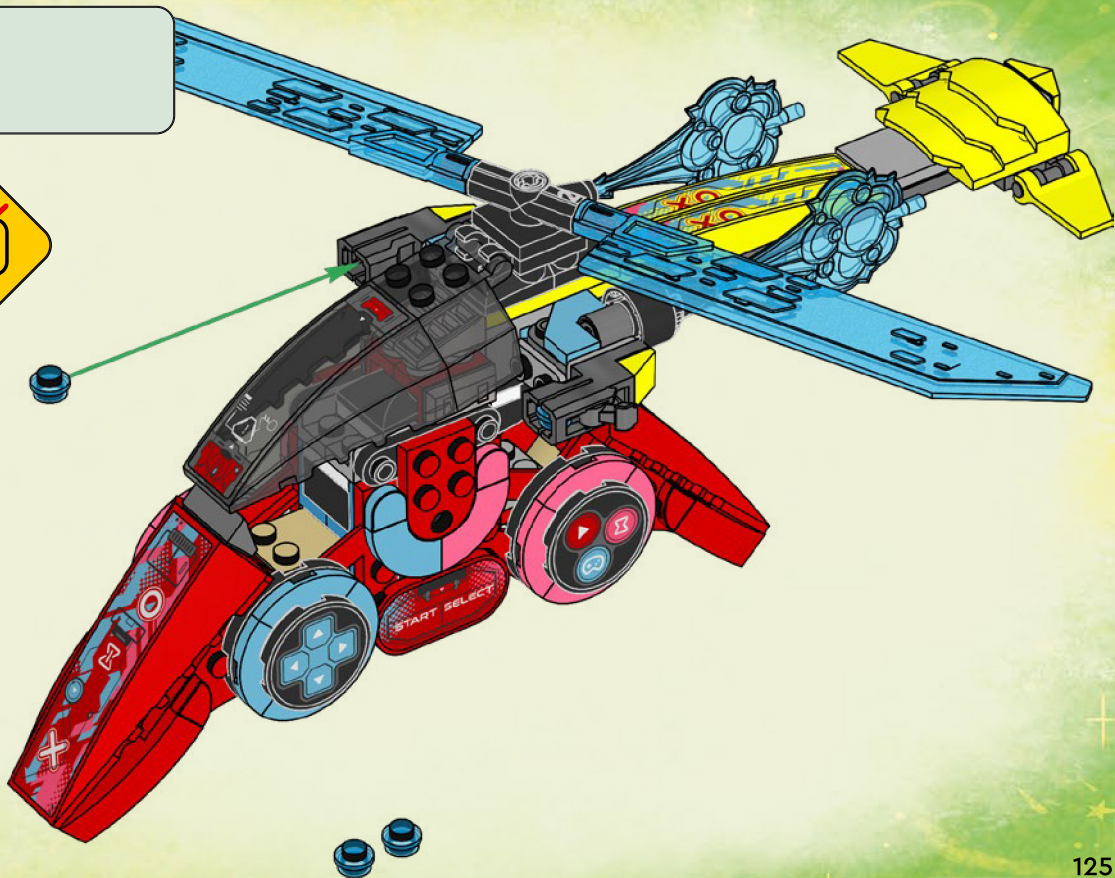

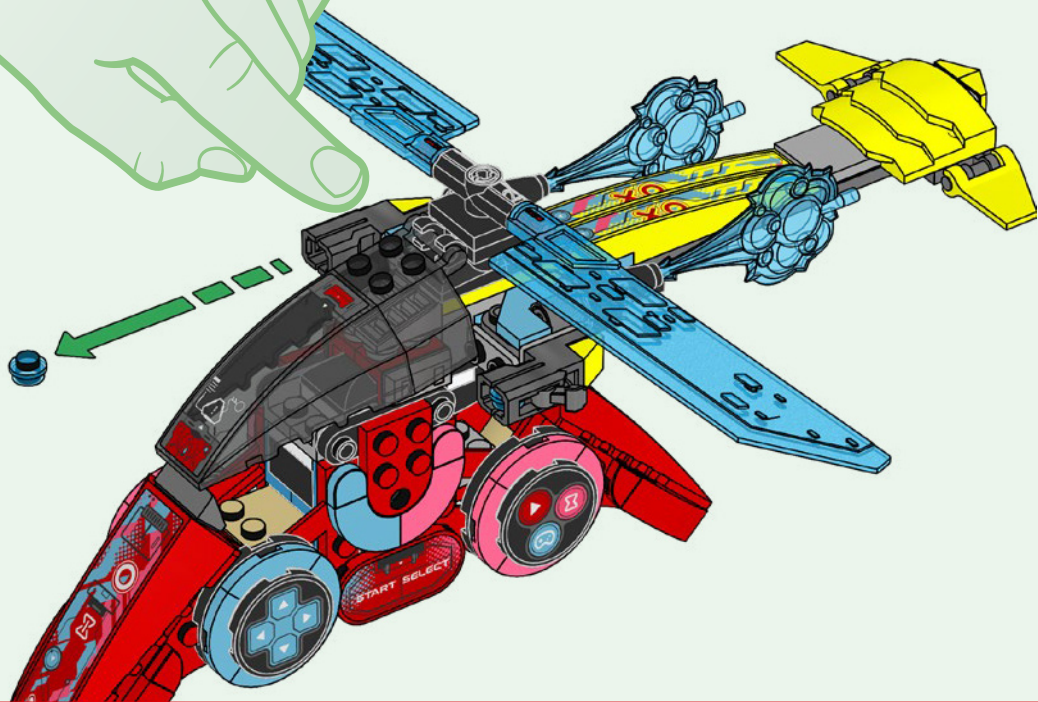





DREAMZZZ



71497



71491



71490



71489



71491



71497



DREAMZZZ

WATCH
SERIES
ONLINE 



Watch series online
Schau dir die Serie online an
Regarde la série en ligne
Guarda la serie online
Mira la serie en Internet
Assistir à série online
在线观看
Oglądaj serial w internecie

Sleduj seriál online
Pozri si seriál online
Nézd a sorozatot online
Vizionează serialul online
Глядайте сериала онлайн
Skaties seriālu tiešsaistē
Vaata sarja veebist
Žiūrėk serialą internetu





6x
6322489



2x
6168642



1x
6348055



2x
302301



1x
6529259



1x
6512375



2x
302001



2x
4624086



3x
4218749



1x
6271228



1x
6221467



1x
6223427



4x
6170390



2x
4142865



1x
6523339



8x
6117974



1x
6105976



2x
6424086



2x
4188189



3x
6438015



4x
6045937



4x
6519440



4x
6394888

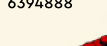

3x
379521



2x
6468176



2x
4206482



1x
6523337



4x
6315887



2x
4529236



2x
6270091



4x
6196548



3x
403226



2x
6291069



1x
6156991



3x
6016172



2x
6336989



2x
6061032



4x
6394979



1x
6313191



1x
6211476



1x
6271869



4x
6376695



2x
6428167



4x
6254045



2x
6039869



4x
4515350



1x
300126



2x
302026



1x
4188534



1x
303426



1x
6523340



4x
6514055



2x
6171732



2x
6530956



1x
6514026



4x
4211525



2x
6439041



2x
6326078



8x
6004990



1x
4211397



3x
6347992



2x
4560183



1x
4211406



1x
6166069



2x
6360675



16x
6221607

1x
4567887

5x
4211042

2x
6019987

2x
4210660

2x
6015356

2x
6469463

8x
6271127

1x
6000970

1x
6501459

2x
6270108

2x
6208446

2x
6167922

2x
6345952

12x
6439745

2x
6375606

2x
6510358

2x
6525399

4x
6445843

2x
6348141

10x
6258069

2x
6119107

1x
4619513

1x
6146926

2x
6475308

10x
6250024

2x
6514353

4x
6427900

2x
6527224

1x
6388037

1x
6527704

2x
6527706

1x
6507965

1x
6490731

 [LEGO.com/service](https://www.LEGO.com/service)



YOU COULD
WIN



Scan this QR code or go to
LEGO.COM/PRODUCTFEEDBACK and give
us your short feedback about this LEGO® set
for a chance to win a cool LEGO prize.

Terms and Conditions apply*



EN: YOU COULD WIN. Terms and Conditions apply* **DE: Du könntest GEWINNEN.** Es gelten die Teilnahmebedingungen* **FR: Tu pourrais GAGNER.** Des conditions s'appliquent* **IT: Potresti VINCERE tu.** Termini e condizioni sono applicabili* **ES: Puedes GANAR.** Aplican términos y condiciones* **PT: Poderá GANHAR.** Aplicam-se termos e condições* **ZH: 轻松获奖. 条款和条件适用*** **PL: Szansa na WYGRANĄ.** Obowiązują warunki korzystania* **CS: Máte šanci VYHRÁT.** Platí všeobecné smluvní podmínky* **SK: Máte šancu VYHRAŤ.** Platia všeobecné zmluvné podmienky* **HU: TE IS NYERHETSZ.** Felhasználási feltételek érvényesek* **RO: Ai putea CÂȘTIGA.** Se aplică termenii și condiții* **BG: Можете да СПЕЧЕЛИТЕ.** Има определени правила и условия* **LV: Tu vari LAIMĒT.** Ir spēkā noteikumi un nosacījumi.* **ET: Sul on võimalus VÕITA.** Kehtivad tingimused* **LT: Jūs galite LAIMĖTI.** Taikomos sąlygos*

*[LEGO.com/productfeedback-terms](https://www.lego.com/productfeedback/terms)