



DREAMZZZ

71490







LEGO® Builder



LEGO.com/sustainable-packaging



 ^{FR} **DONNEZ**
OU
RECYCLEZ

 OU  OU 

ASSOCIATION MAGASIN DÉCHÈTERIE

Adresses sur quefairedemesdechets.fr



Q LEGO® Builder

BUILDER



Apple and the Apple logo are trademarks of Apple Inc., registered in the U.S. and other countries and regions. App Store is a service mark of Apple Inc. Google Play and the Google Play logo are trademarks of Google LLC. Tencent and the Tencent logo are trademarks of Tencent Inc.

Q [LEGO.com/devicecheck](https://www.lego.com/devicecheck)

EN Ask parents' permission before going online | DE Eltern um Erlaubnis bitten, bevor du online gehst | FR Demande l'autorisation d'un parent avant d'aller en ligne | IT Chiedi il permesso ai tuoi genitori prima di andare online | ES Pídeles permiso a tus papás antes de conectarte a Internet | PT Pede autorização aos pais antes de acederes online | ZH 上网前应先征得父母的同意 | PL Poproś rodziców o zgodę, zanim wejdiesz do Internetu | CS Než půjdeš na internet, požádej rodiče o svolení | SK Skôr než pôjdeš na internet, vypýtaj si povolenie od rodičov | HU Kérj szülői engedélyt, mielőtt online csatlakoznál! | RO Cere permisiunea părinților înainte de a te conecta online | BG Поискайте разрешение от родител, преди да влезете онлайн | LV Pirms došanās tiešsaistē palūdz atļauju vecākiem | ET Enne Interneti kasutamist küsi vanematelt luba | LT Prieš prisijungdami prie interneto, atsiklauskite tėvų

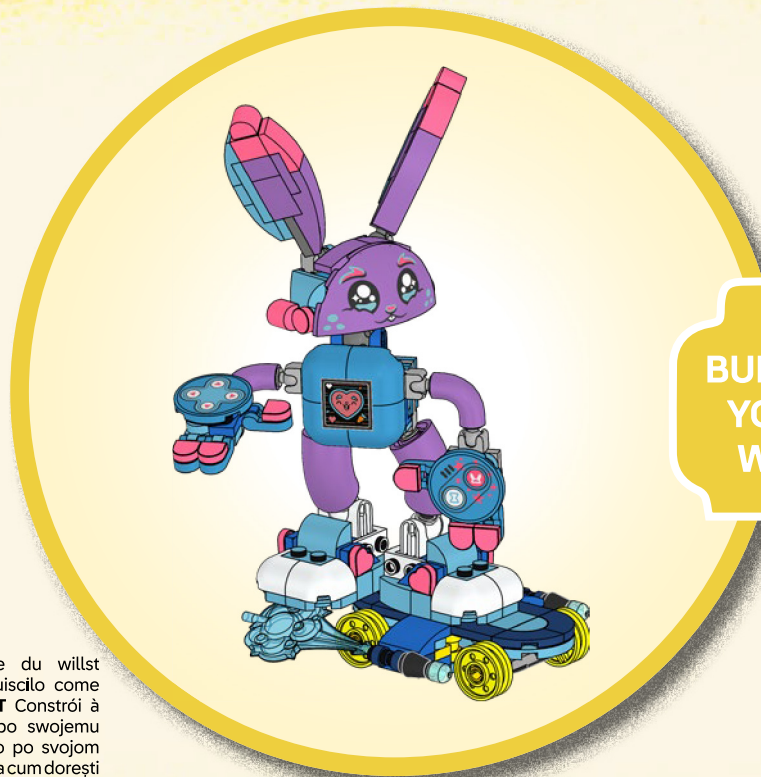

**BUILD IT
YOUR
WAY**



EN Build It Your Way | **DE** Bau, wie du willst
| **FR** Construisez à votre façon | **IT** Costruiscilo come
vuoi tu | **ES** Constrúyelo a tu manera | **PT** Constrói à
Tua Maneira | **ZH** 自由拼搭 | **PL** Zbuduj po swojemu
| **CS** Postavte to po svém | **SK** Postavte to po svojom
| **HU** Építs kedved szerint! | **RO** Construięște așa cum dorești
| **BG** Постройте го по своя начин | **LV** Būvē tieši tā, kā
vēlies | **ET** Ehita enda moodi | **LT** Sukonstruokite savaip

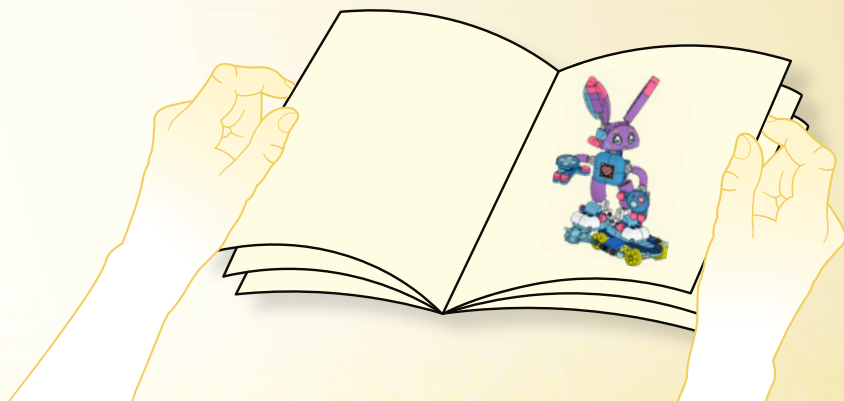
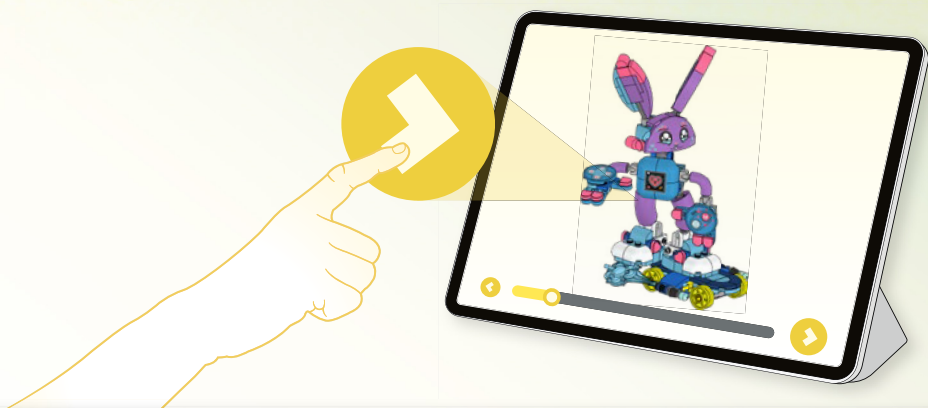







1

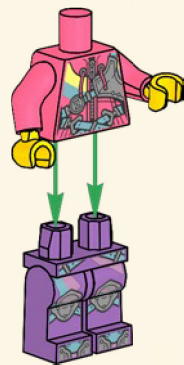

2

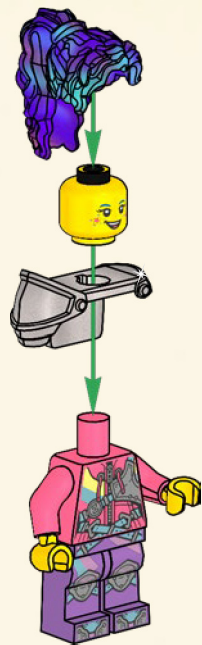

3

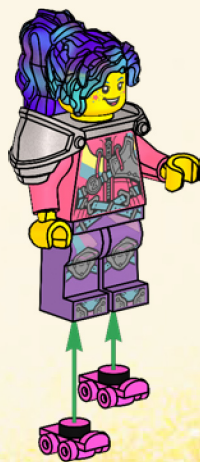

4



1



2





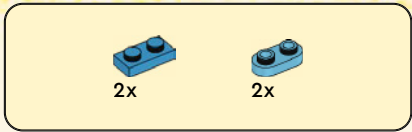
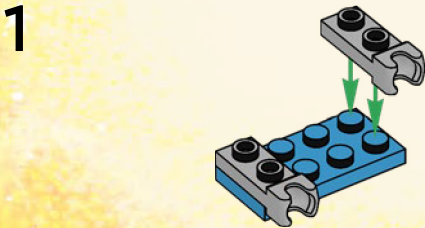
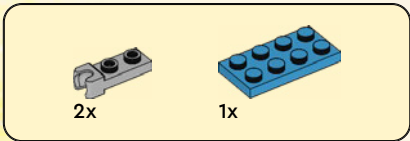
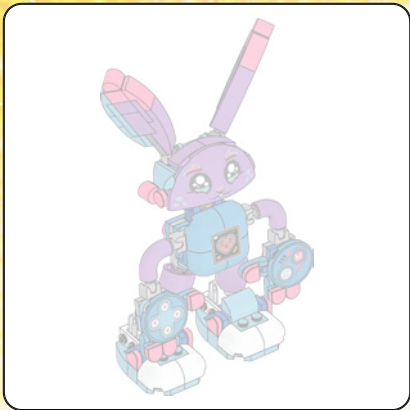

2

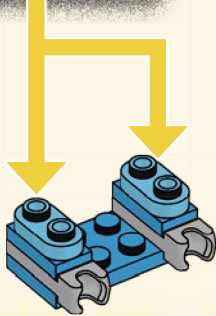
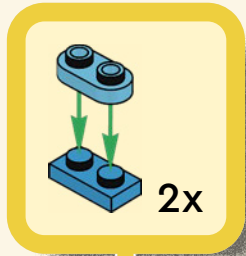

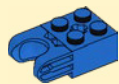

1x

3

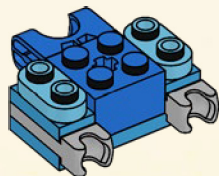

2x

4

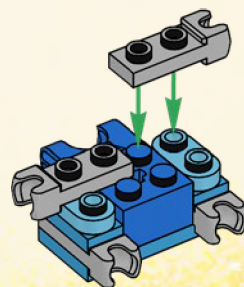



2x

5



2x

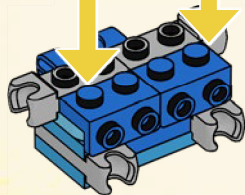

1x



1x

6

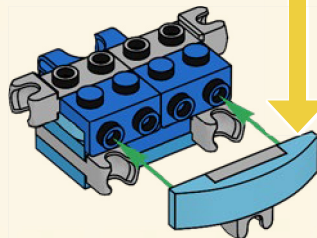
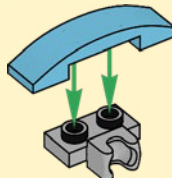



1x

7

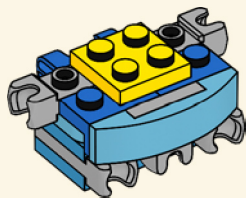

4x

8

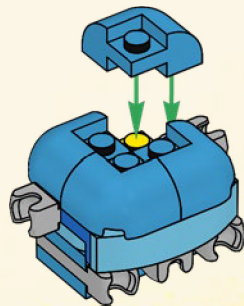



1x

9

1



2

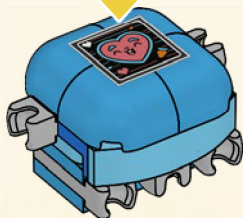



10

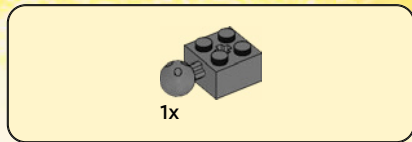
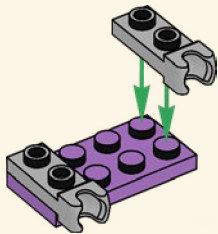

11

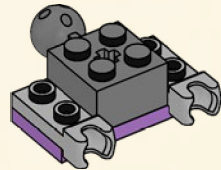



2x

12

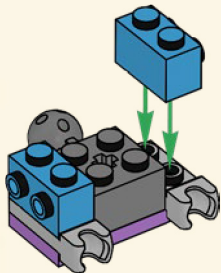

1x



1x

13

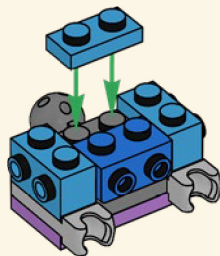

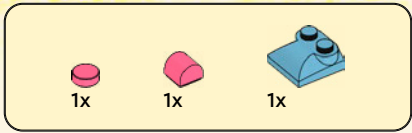

14

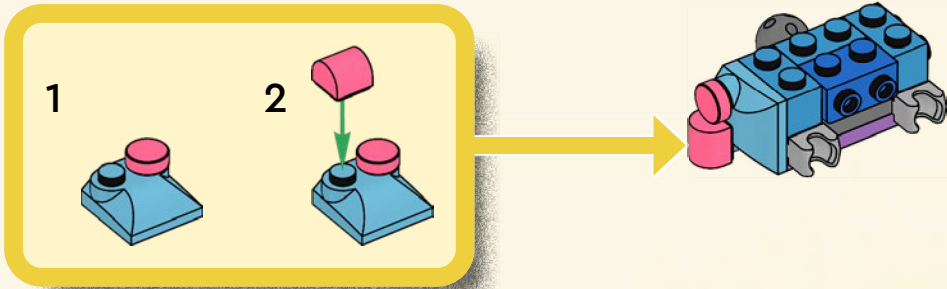



15

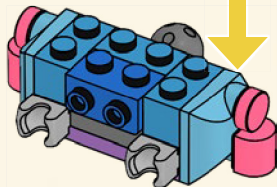
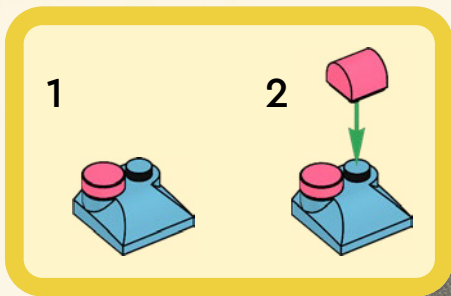



2x



1x

16

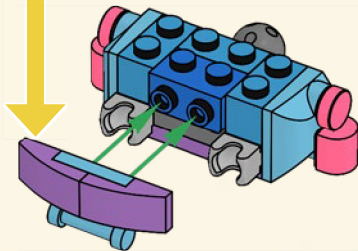
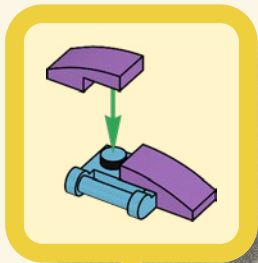

1x

17

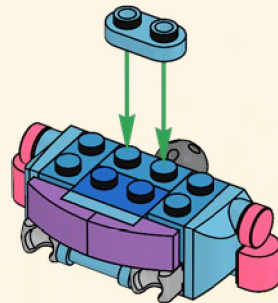



18

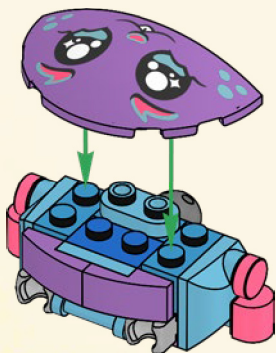

19

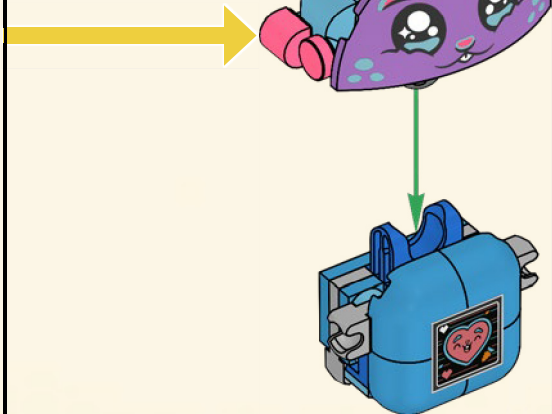

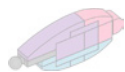

2x



1x



1x

20

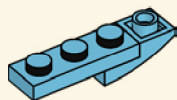

1x



1x

21

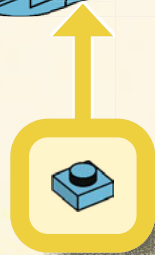
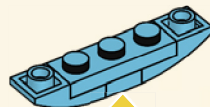



1x



1x

22

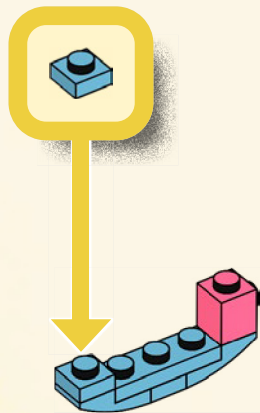

1x



1x

23

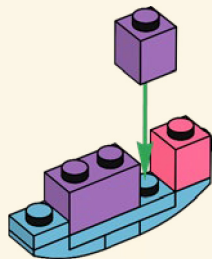



1x



1x

24

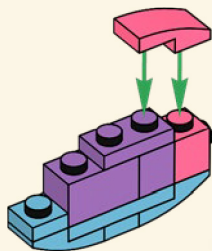

1x

25

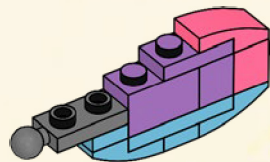



1x

26

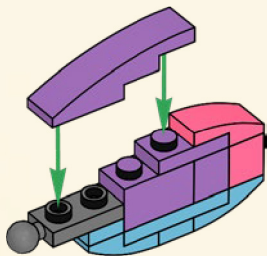

1x

27

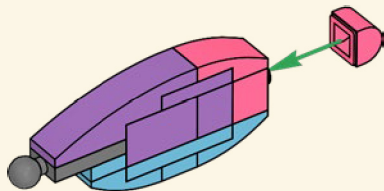

2x

28

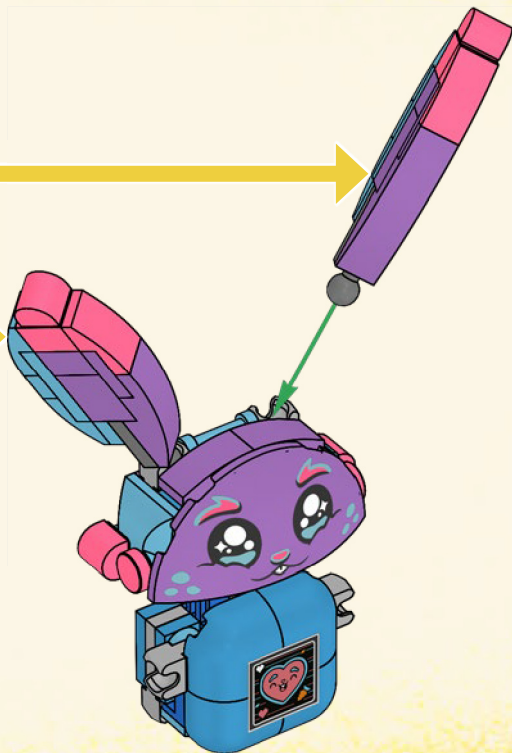

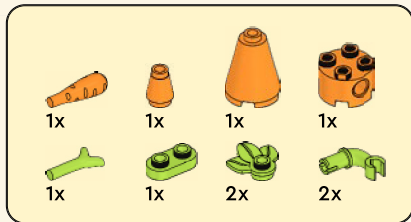

1



2

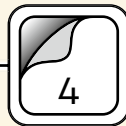



3



4



5

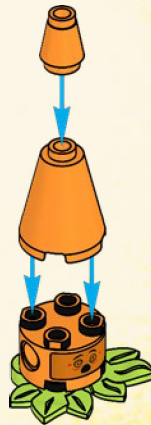

6

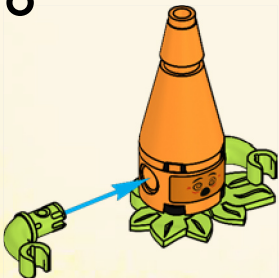

7

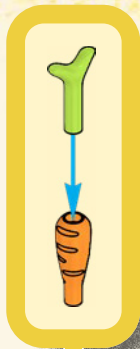
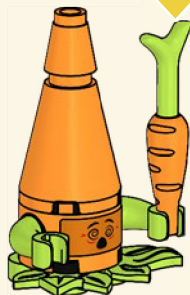





2x



1x

29



2x

30

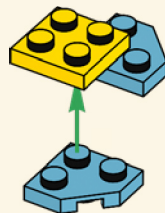



2x

31

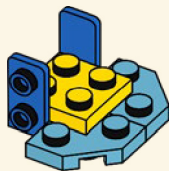

2x

32





1x

33

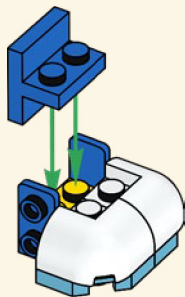



1x

34

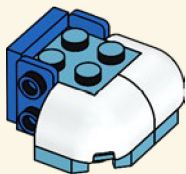

1x

35

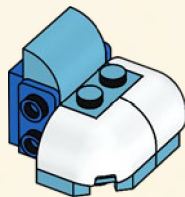



2x

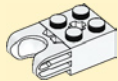

1x

36

1

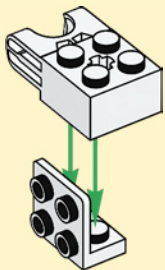

2

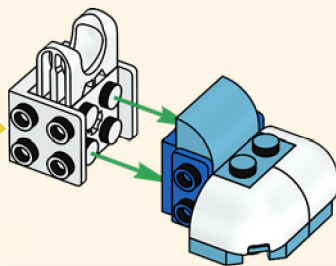
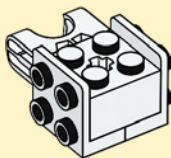



1x

37

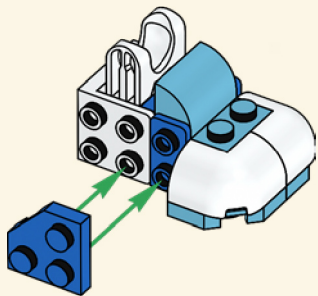

1x



1x

38

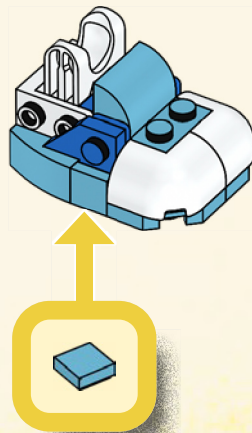



1x

39

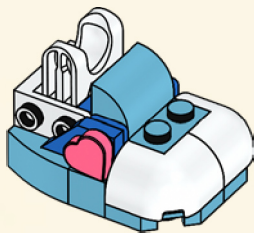

1x

40

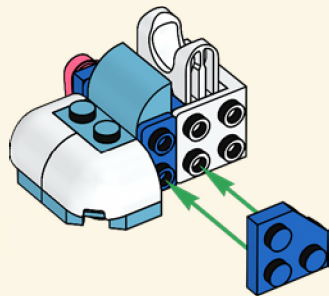



1x



1x

41

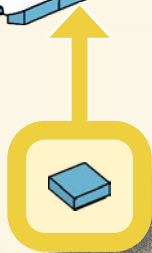
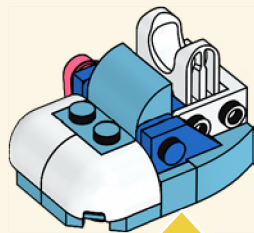

1x

42

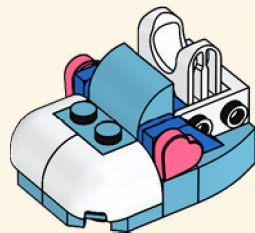

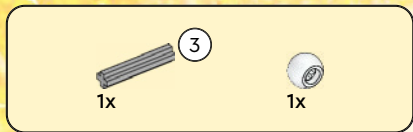

43

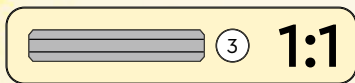
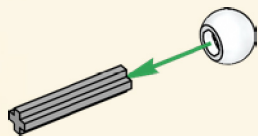

44

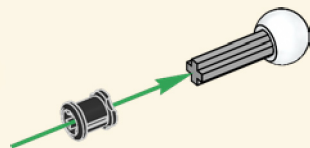



45

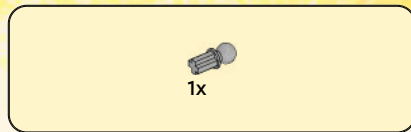
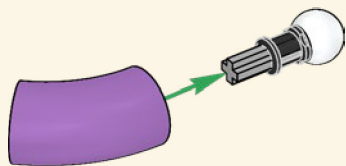

46

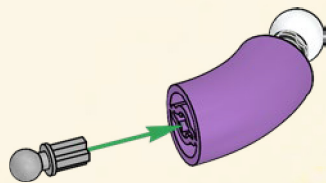

47

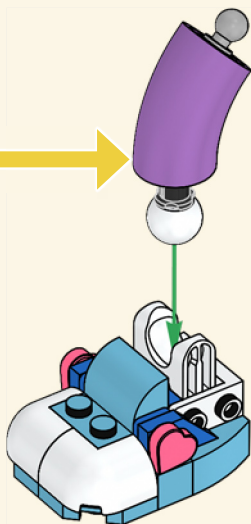

2x

48

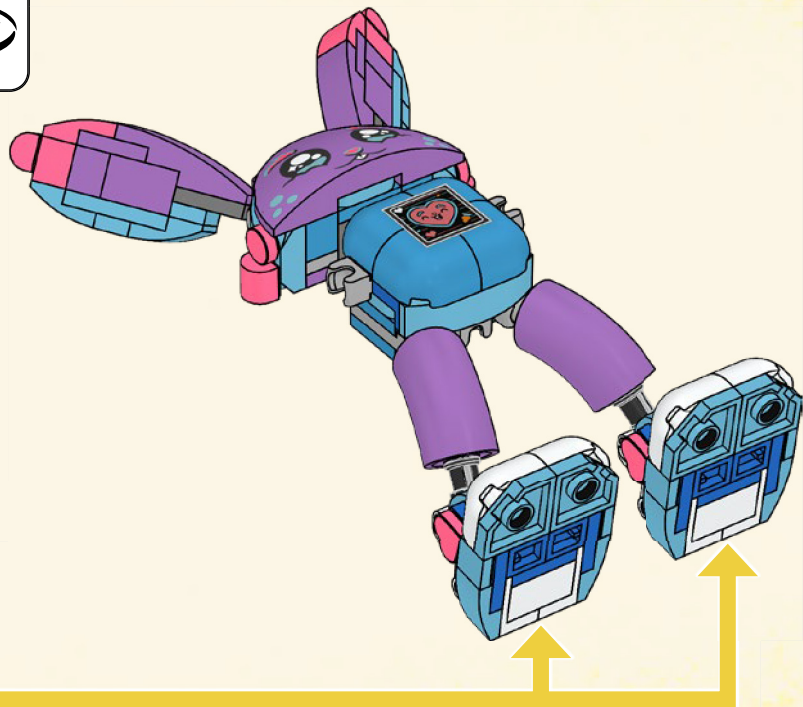



1x



1x

49

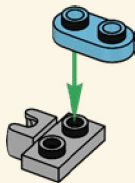

1x

50

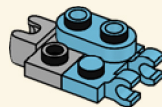



1x

51

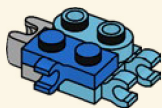

1x

52

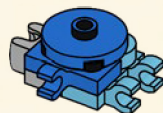

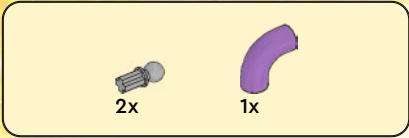

53

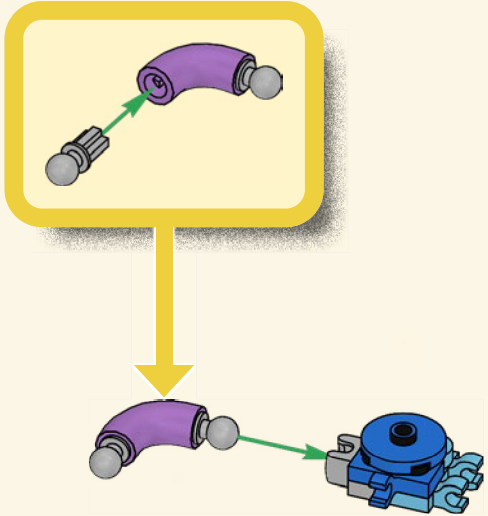



3x



3x

54

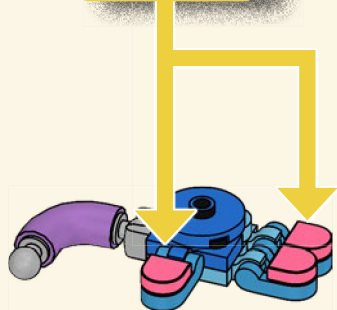

1x

55

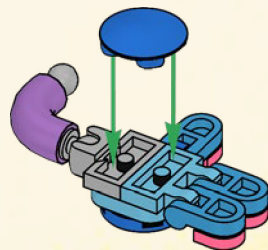



1x

56

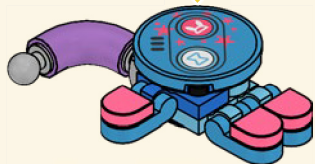
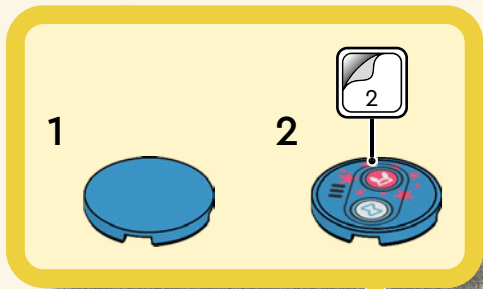

57

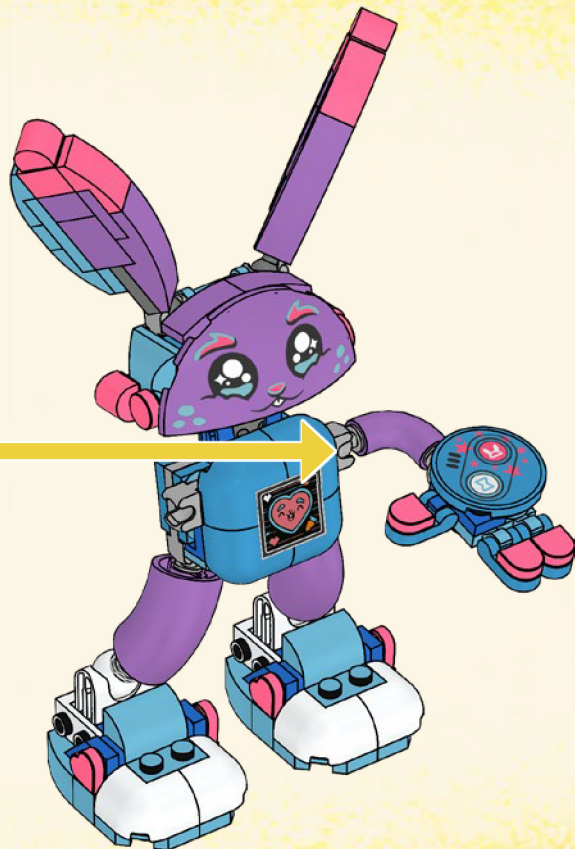
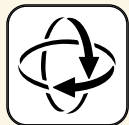



1x



1x

58

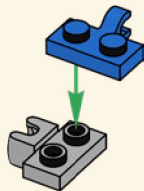

1x

59

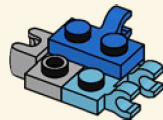



1x

60

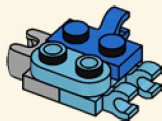

1x

61

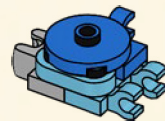



3x



3x

62

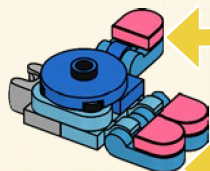

2x

1x

63

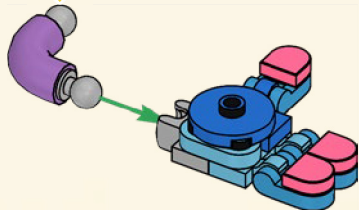
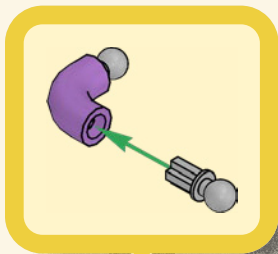

1x

64

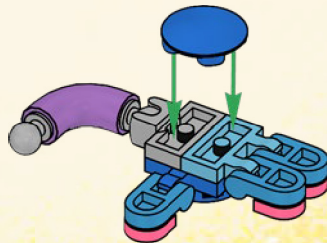



1x

65

1



2



3

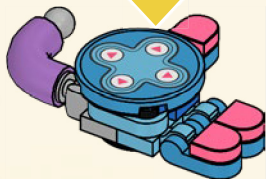

66

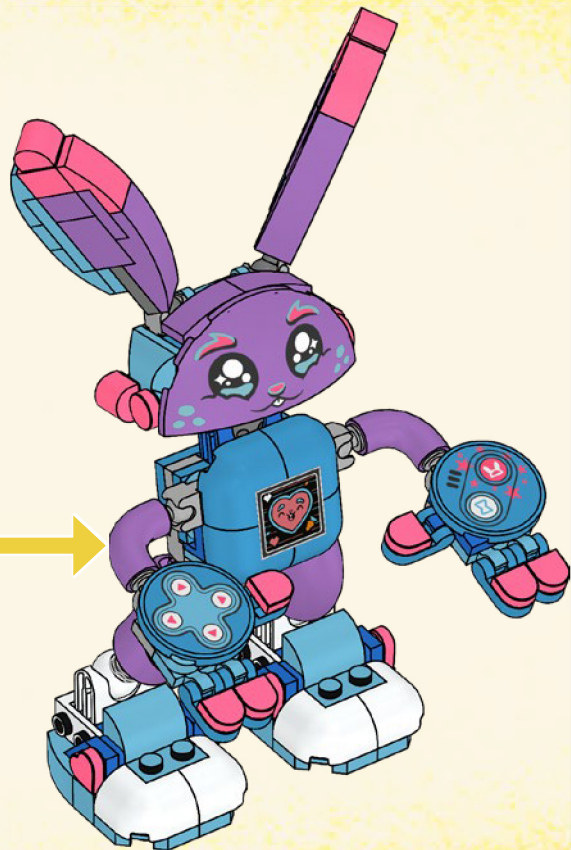



67

1



2



3



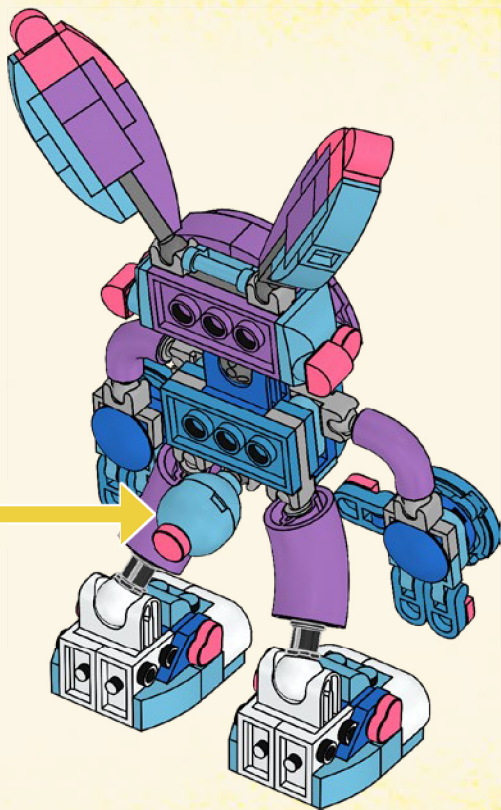



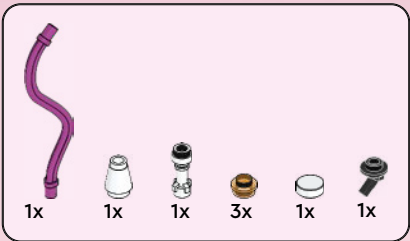
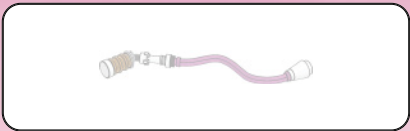

1



2



3



4



5

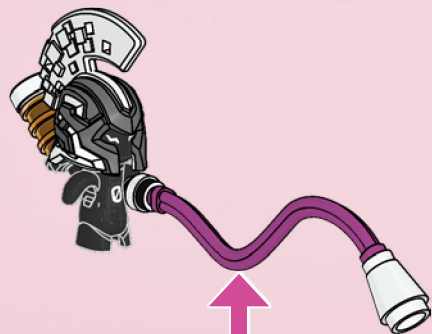



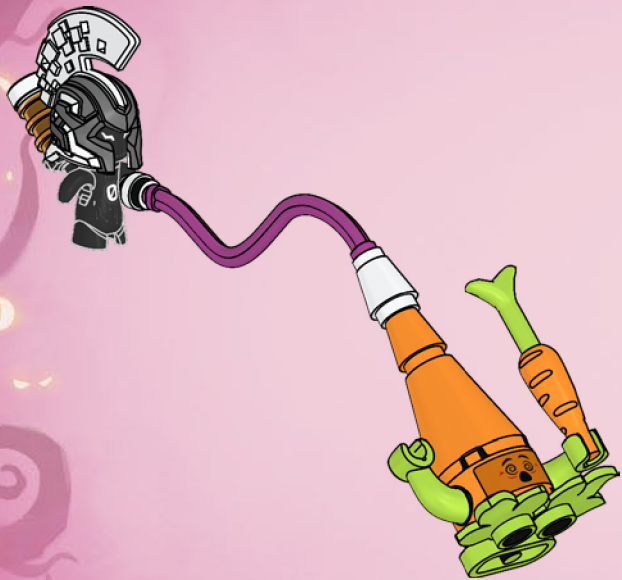



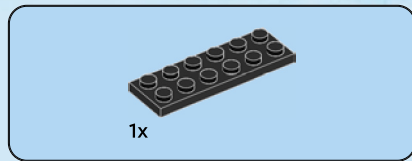
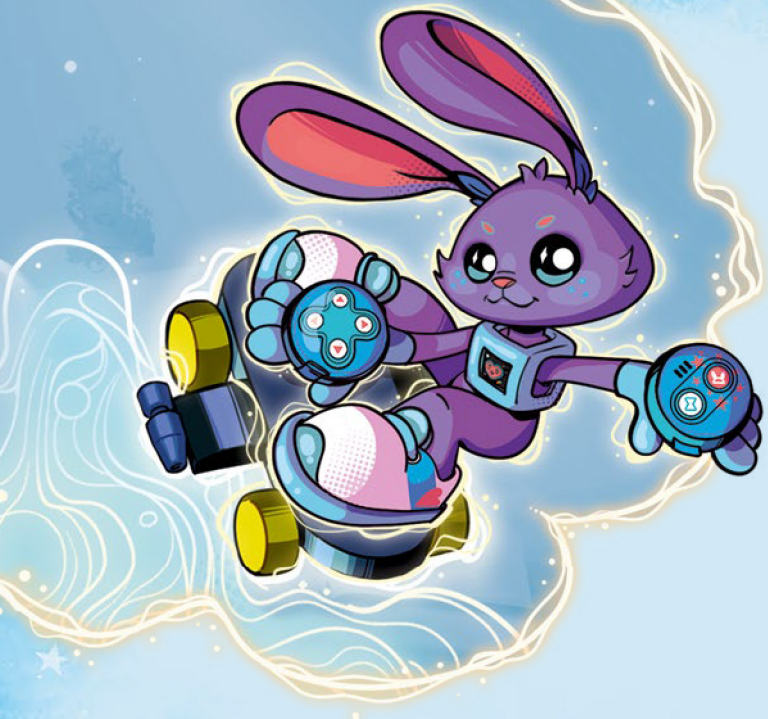

1x

1

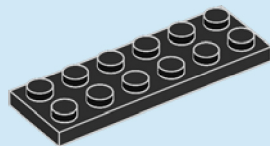



2x

2

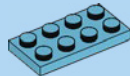
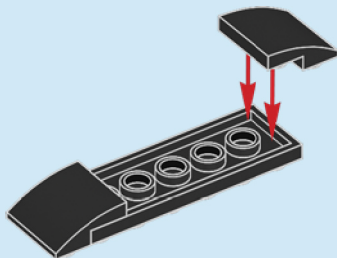

1x

3

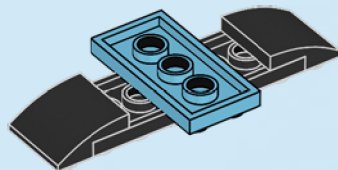

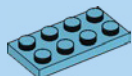

1x

4

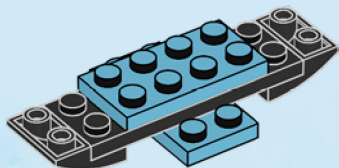

1x

5

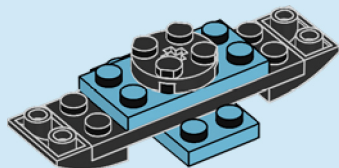

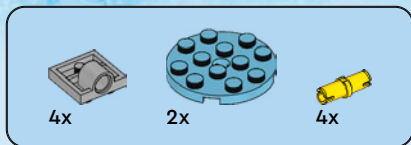

6

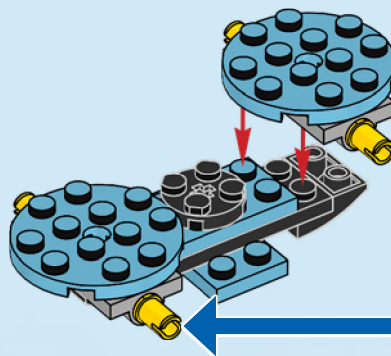
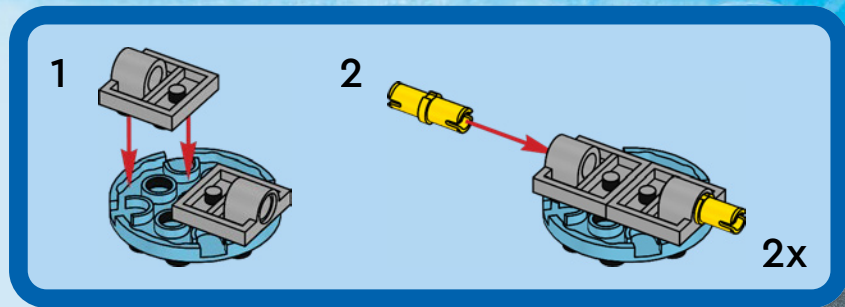



2x

7

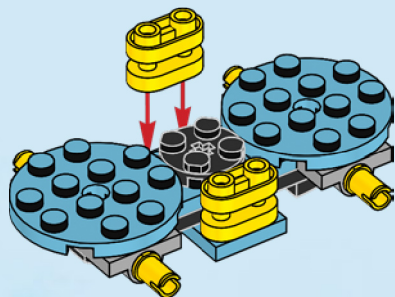

2x

8

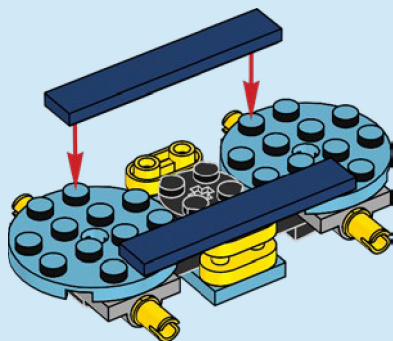



2x

9

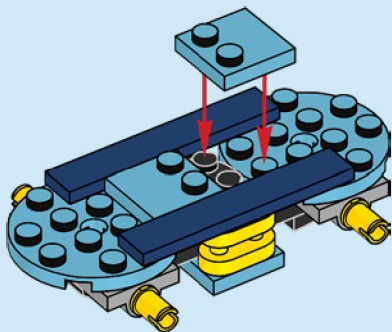

4x

10

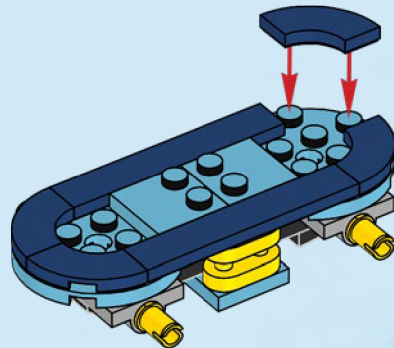



2x



2x

11

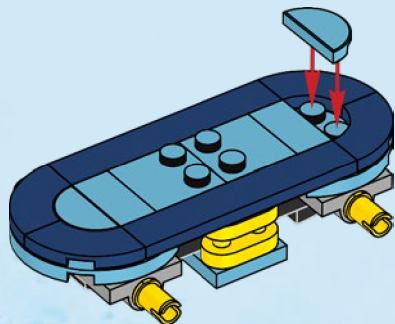

4x

12

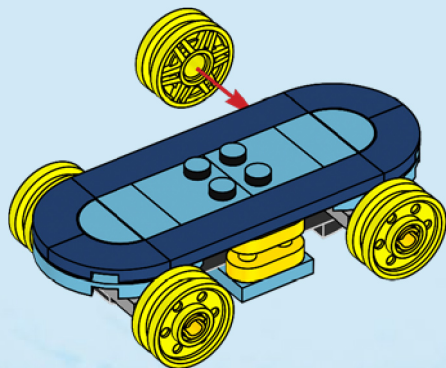

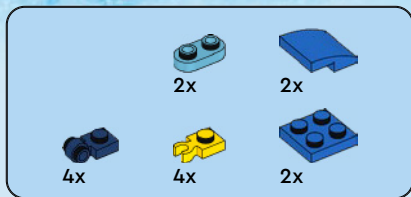

13

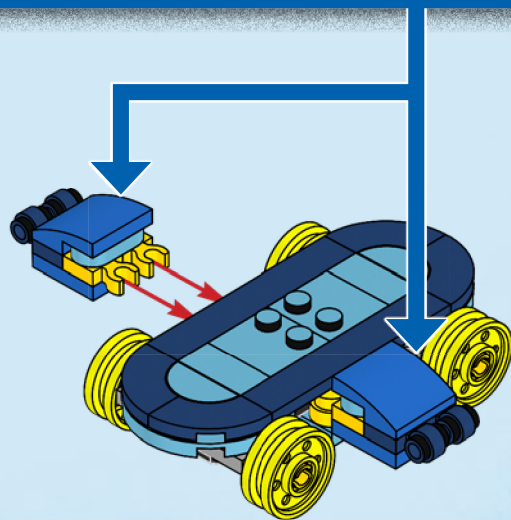
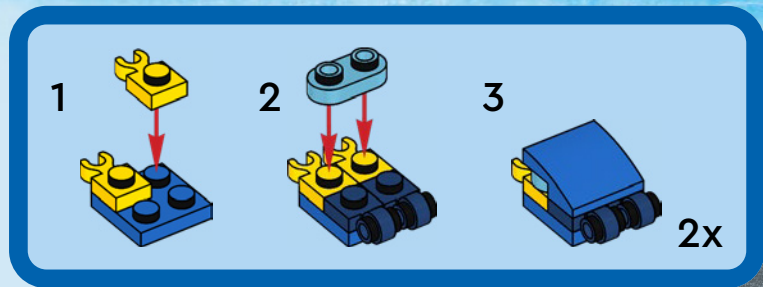



2x



2x

14



2x

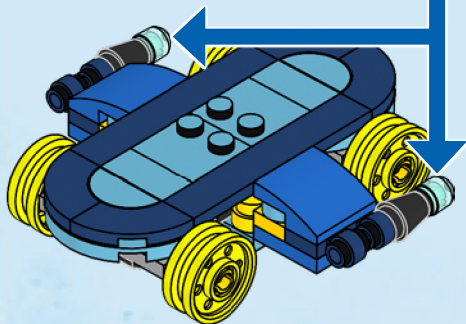

2x

15

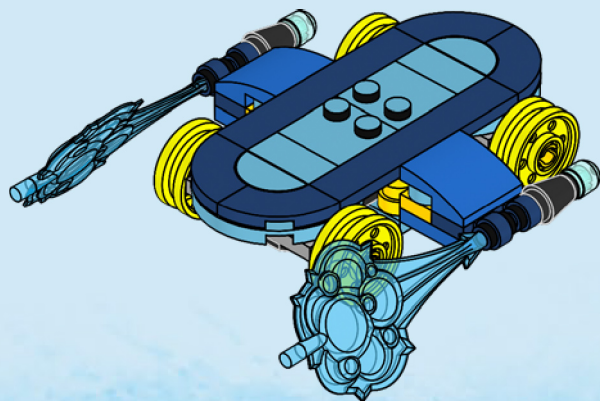



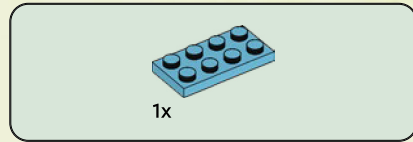

1

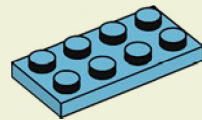



1x

2

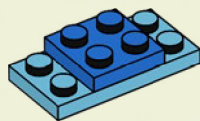

1x



1x

3

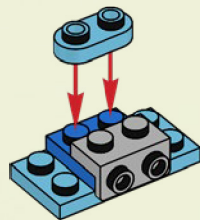



2x

4

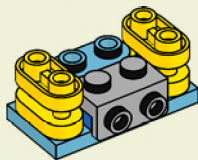



1x

5

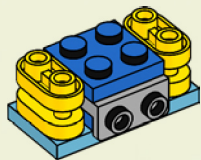

2x

6

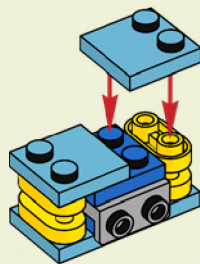

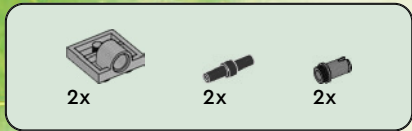

7

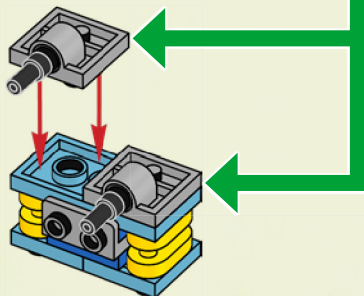
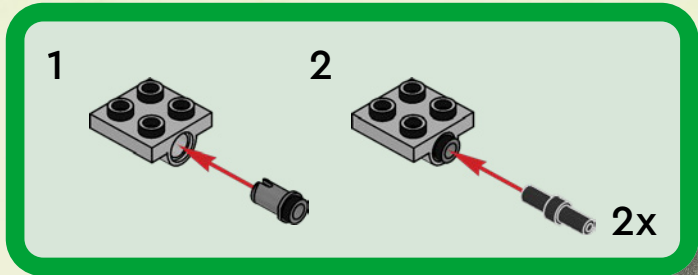



2x

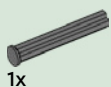

1x

4



1x

8

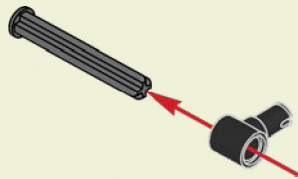

4

1:1



2x



1x

9

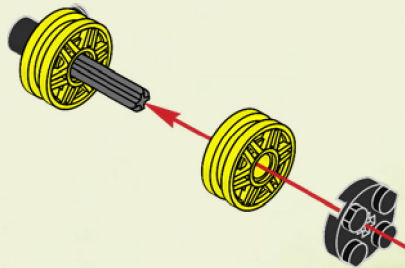



1x

10

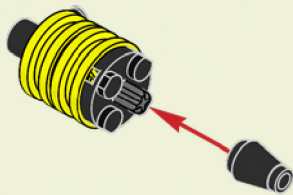



11

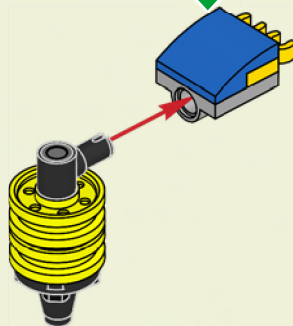
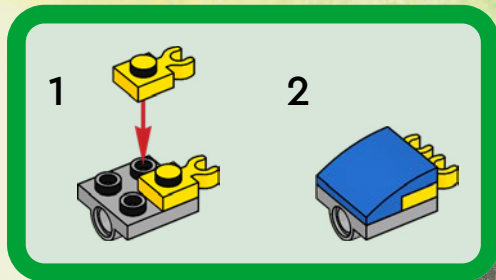

2x

12

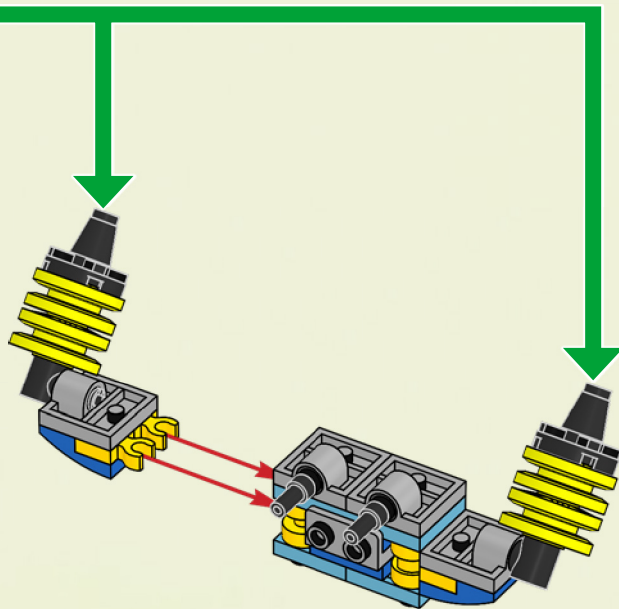

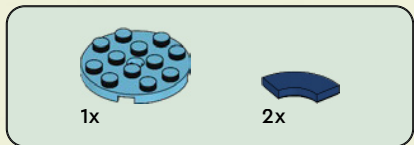

13

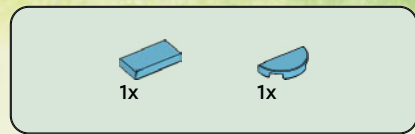
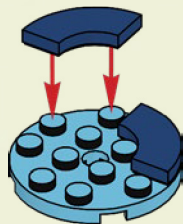

14

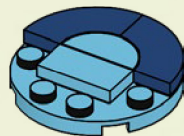



1x



1x

15

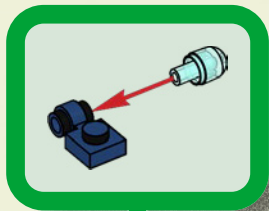

1x



1x



1x

16



1

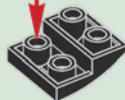

2



17

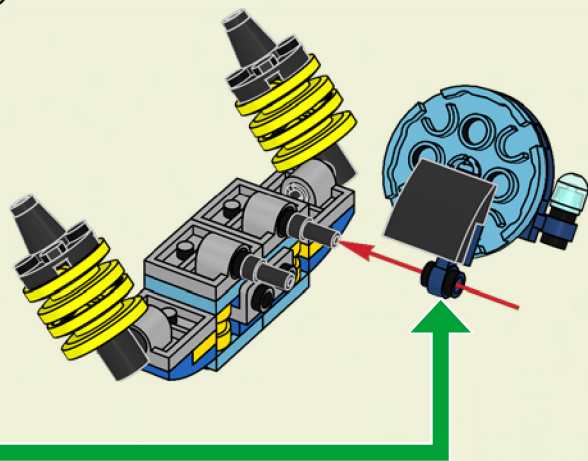



1x



2x

18

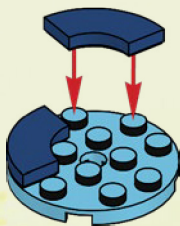

1x



1x

19





1x



1x

20

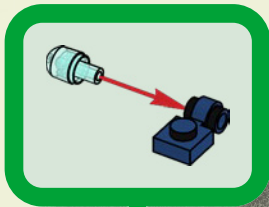

1x



1x



1x

21



1

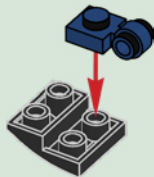

2

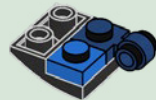

22

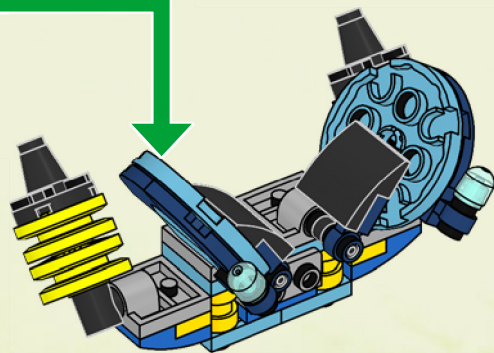



2x

23

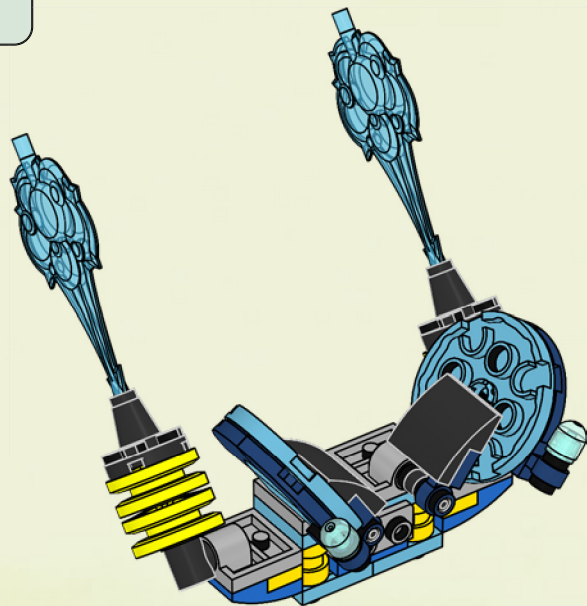

24

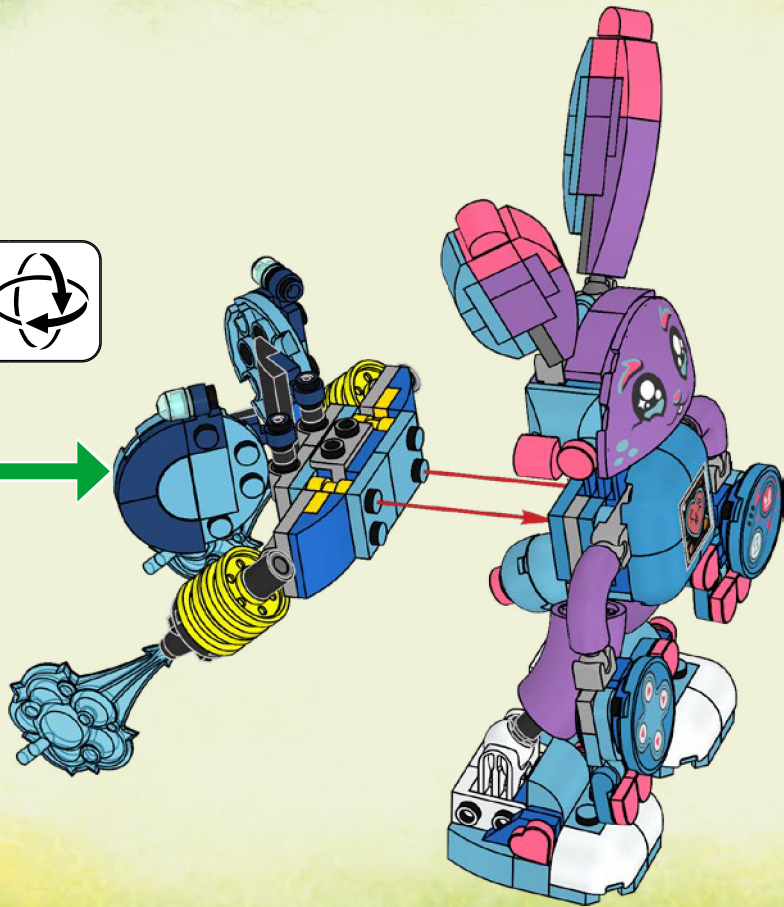





DREAMZZZ



71497



71491



71490



71489



71491



71497



DREAMZZZ

WATCH
SERIES
ONLINE 



Watch series online
Schau dir die Serie online an
Regarde la série en ligne
Guarda la serie online
Mira la serie en Internet
Assistir à série online
在线观看
Oglądaj serial w internecie

Sleduj seriál online
Pozri si seriál online
Nézd a sorozatot online
Vizionează serialul online
Гледайте сериала онлайн
Skaties seriālu tiešsaistē
Vaata sarja veebist
Žiūrėk serialą internetu





1x
6040333



1x
6284572



1x
4518400



2x
6052864



1x
6528261



4x
6097637



4x
6519991



2x
6360826



2x
302423



2x
4278276

94



4x
6344218



2x
6194417



4x
6390153



2x
6313131



3x
6163471



2x
6446707



2x
6116786



2x
302223



1x
6406931



1x
6434190



2x
6529612



4x
6348065



4x
6331822



3x
302224



2x
4529236



1x
6510193



2x
6332148



1x
6523345



1x
6523346



2x
6371584



2x
403226



2x
6282140



1x
306826



2x
6211476



1x
379526



2x
6507870



1x
6247792



2x
6530956



1x
4518029



1x
6533789



1x
6120639



1x
6424015



1x
6264062



2x
6286831



1x
6420268



2x
6320142



1x
6527625



4x
6328107



4x
6199898



2x
4252437



3x
6240227



6x
6443149



3x
6043656



1x
4654582



4x
6045988



2x
4211815



6x
6043639

3

2x
6395635

1x
6364352

2x
6123814

2x
6083620

1x
4497253

1x
6190252

1x
6501459

1x
6301362

6x
6481638

3x
4653988

2x
6523387

4x
6529613

2x
6529284

1x
6210675

2x
6346263

4x
4655243

4x
6097493

2x
6510074

1x
6132411

1x
6429058

2x
6236578

4x
6071246

4x
6249415

4x
6529615

2x
4649741

2x
6337269

1x
6236582

2x
4625032

7x
6396673

2x
6439273

2x
6357615

2x
6119107

1x
6097093

2x
6102828

2x
4655256

2x
4651903

2x
6482111

1x
6537303

2x
4619512

2x
4623598

2x
6136331

2x
6529611

2x
6529614

1x
4619516

1x
6523347

3x
6311436

4x
6488474

6x
6475308

2x
6261292

4x
6422223

2x
6258075

1x
6529016

1x
6530803

1x
6503197

4x
6529084

4

 [LEGO.com/service](https://www.LEGO.com/service)

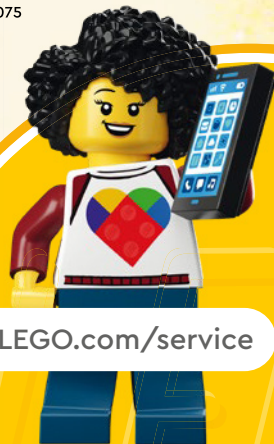

**YOU COULD
WIN**



Scan this QR code or go to
LEGO.COM/PRODUCTFEEDBACK and give
us your short feedback about this LEGO® set
for a chance to win a cool LEGO prize.

Terms and Conditions apply*

EN: YOU COULD WIN. Terms and Conditions apply* **DE: Du könntest GEWINNEN.** Es gelten die Teilnahmebedingungen* **FR: Tu pourrais GAGNER.** Des conditions s'appliquent* **IT: Potresti VINCERE tu.** Termini e condizioni sono applicabili* **ES: Puedes GANAR.** Aplican términos y condiciones* **PT: Poderá GANHAR.** Aplicam-se termos e condições* **ZH: 轻松获奖. 条款和条件适用*** **PL: Szansa na WYGRANĄ.** Obowiązują warunki korzystania* **CS: Máte šanci VYHRÁT.** Platí všeobecné smluvní podmínky* **SK: Máte šancu VYHRAŤ.** Platia všeobecné zmluvné podmienky* **HU: TE IS NYERHETSZ.** Felhasználási feltételek érvényesek* **RO: Ai putea CÂȘTIGA.** Se aplică termenii și condiții* **BG: Можете да СПЕЧЕЛИТЕ.** Има определени правила и условия* **LV: Tu vari LAIMĒT.** Ir spēkā noteikumi un nosacījumi.* **ET: Sul on võimalus VÕITA.** Kehtivad tingimused* **LT: Jūs galite LAIMĖTI.** Taikomos sąlygos*

*[LEGO.com/productfeedback/terms](https://www.lego.com/productfeedback/terms)