



MINECRAFT

21269







Q LEGO® Builder



LEGO.com/sustainable-packaging



 ^{FR} **DONNEZ**
OU
RECYCLEZ

 OU  OU 

ASSOCIATION MAGASIN DÉCHÈTERIE

Adresses sur quefairedemesdechets.fr

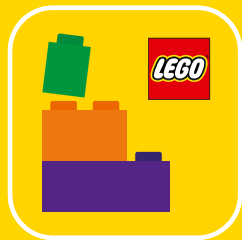

Q LEGO® Builder

BUILDER



Apple and the Apple logo are trademarks of Apple Inc., registered in the U.S. and other countries and regions. App Store is a service mark of Apple Inc. Google Play and the Google Play logo are trademarks of Google LLC. Tencent and the Tencent logo are trademarks of Tencent Inc.

Q LEGO.com/devicecheck

EN Ask parents' permission before going online | DE Eltern um Erlaubnis bitten, bevor du online gehst | FR Demande l'autorisation d'un parent avant d'aller en ligne | IT Chiedi il permesso ai tuoi genitori prima di andare online | ES Pídeles permiso a tus papás antes de conectarte a Internet | PT Pede autorização aos pais antes de acederes online | ZH 上网前应先征得父母的同意 | PL Poproś rodziców o zgodę, zanim wejdiesz do Internetu | CS Než půjdeš na internet, požádej rodiče o svolení | SK Skôr než pôjdeš na internet, vypýtaj si povolenie od rodičov | HU Kérj szülői engedélyt, mielőtt online csatlakoznál! | RO Cere permisiunea părinților înainte de a te conecta online | BG Поискайте разрешение от родител, преди да влезете онлайн | LV Pirms došanās tiešsaistē palūdz atļauju vecākiem | ET Enne Interneti kasutamist küsi vanematelt luba | LT Prieš prisijungdami prie interneto, atsiklauskite tėvų

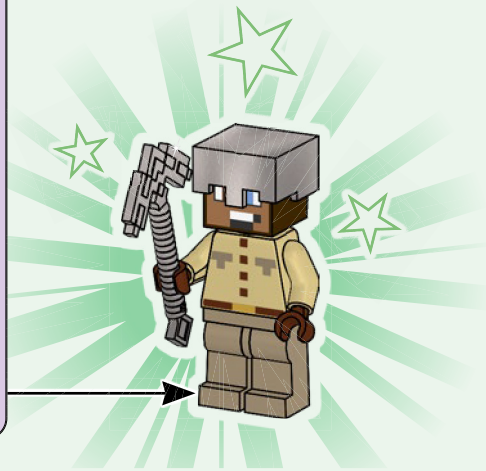
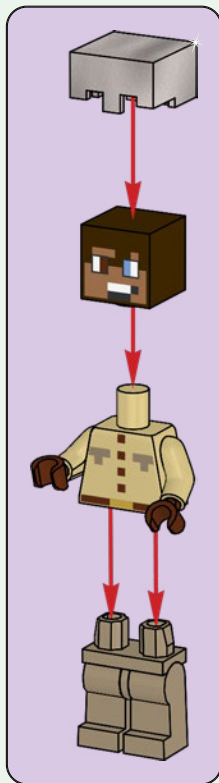

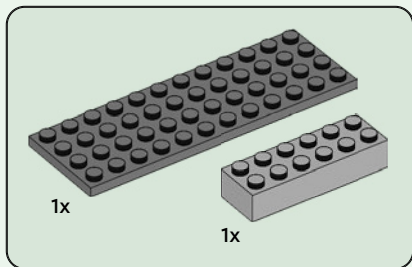

1

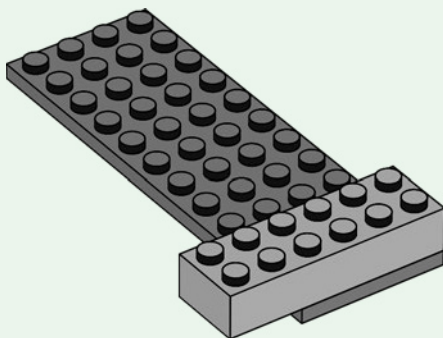

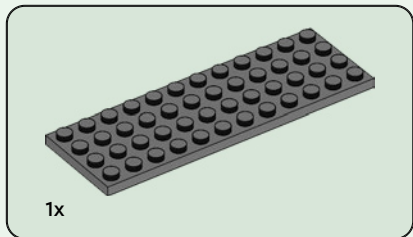

2

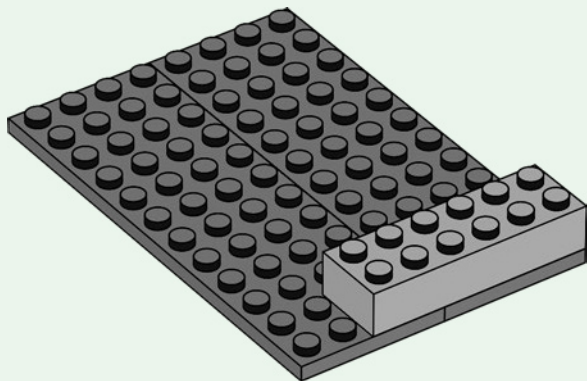

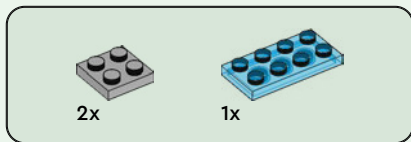

3

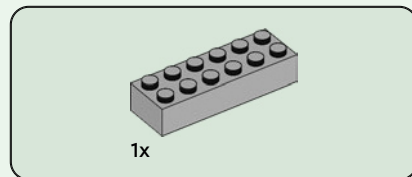
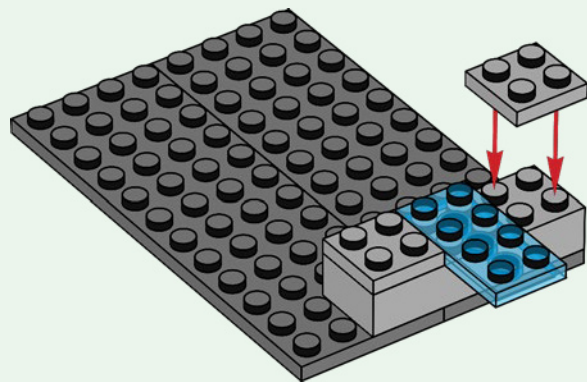

4

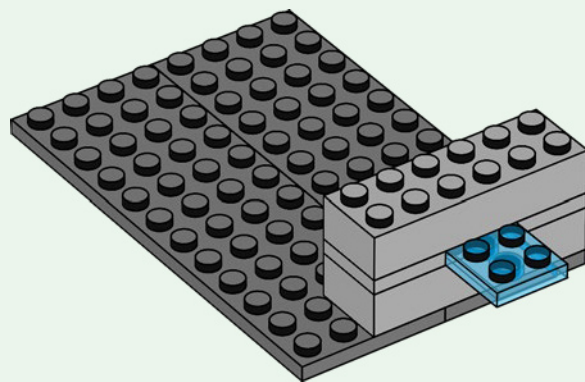

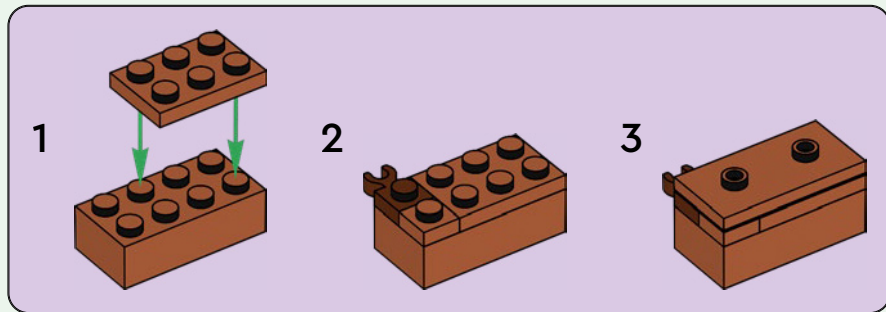
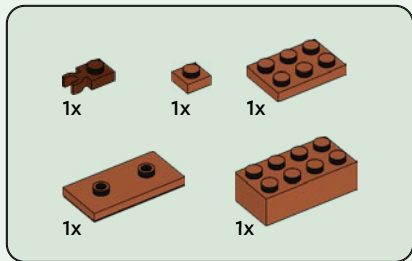

5

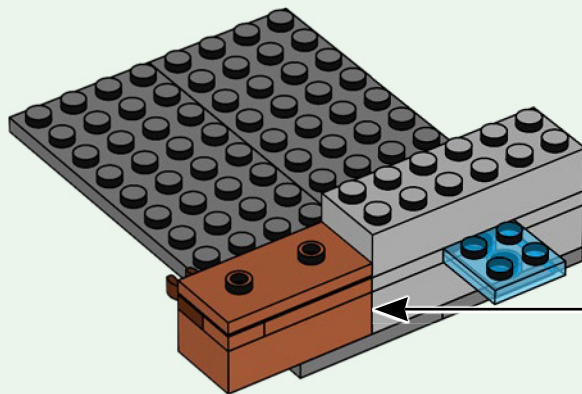

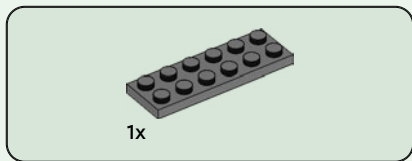

6

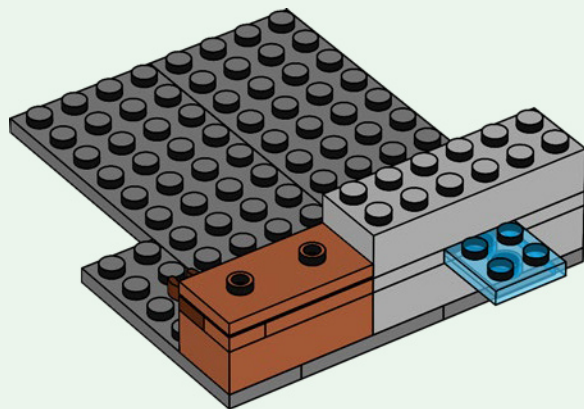



3x

7

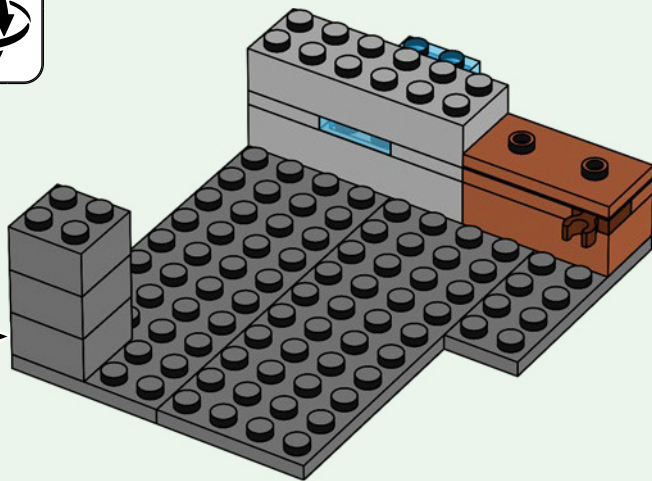
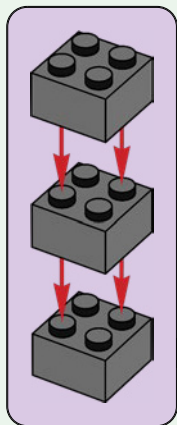



1x

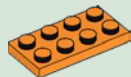

1x

8

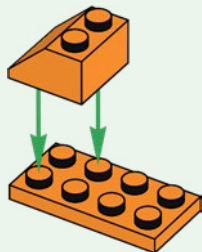

1x



1x

9

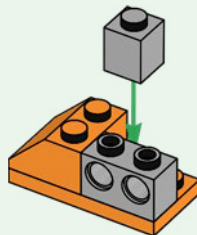

1x



2x

10

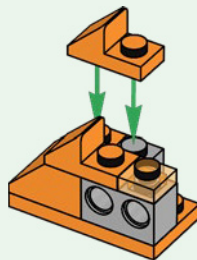



1x

11

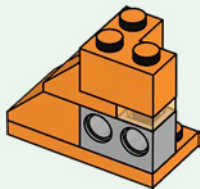

12

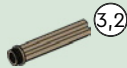

1x



1x

12

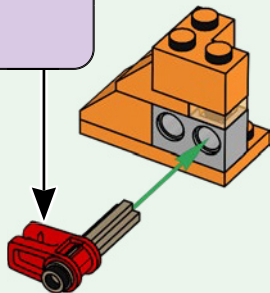
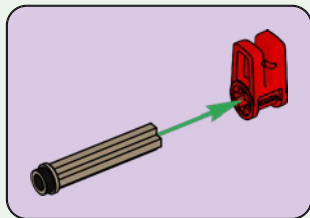

3,2

1:1



1x

13

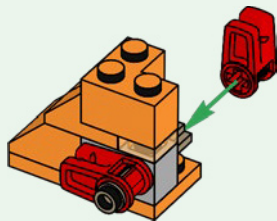

14

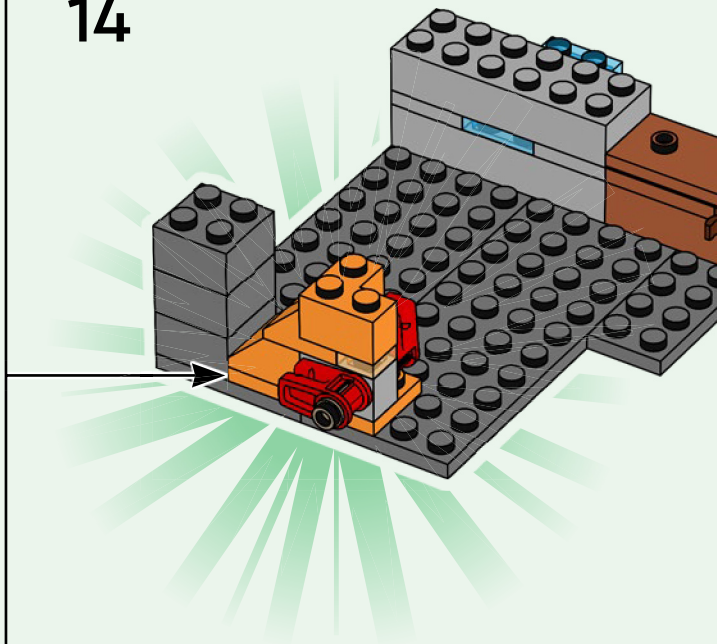

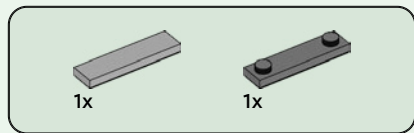

15

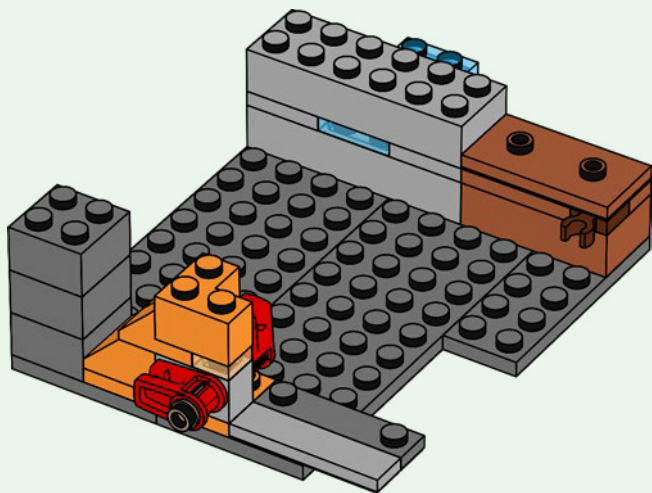

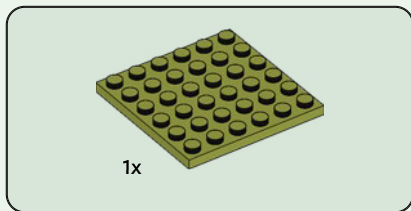

16

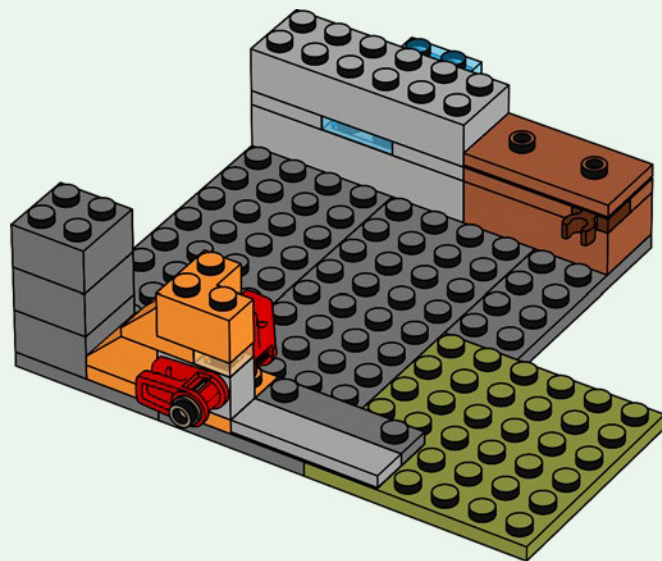

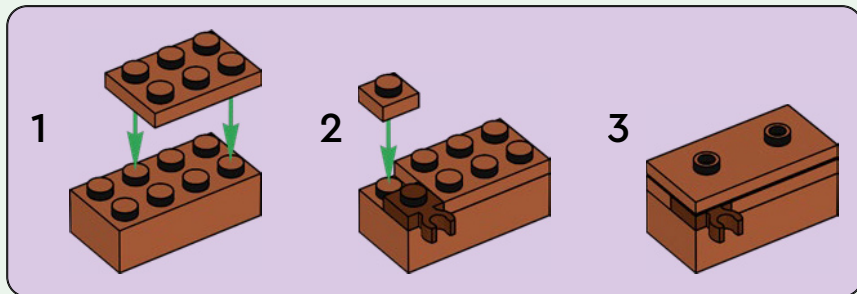
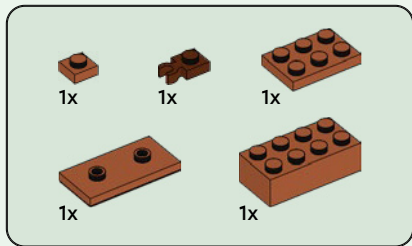

17

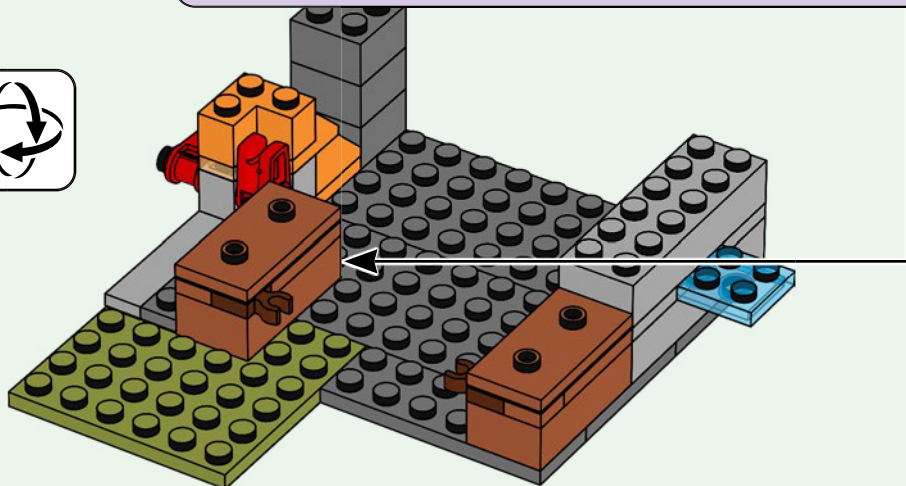

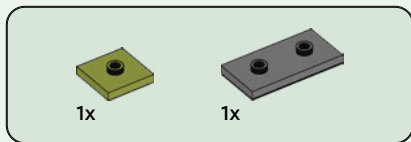

18

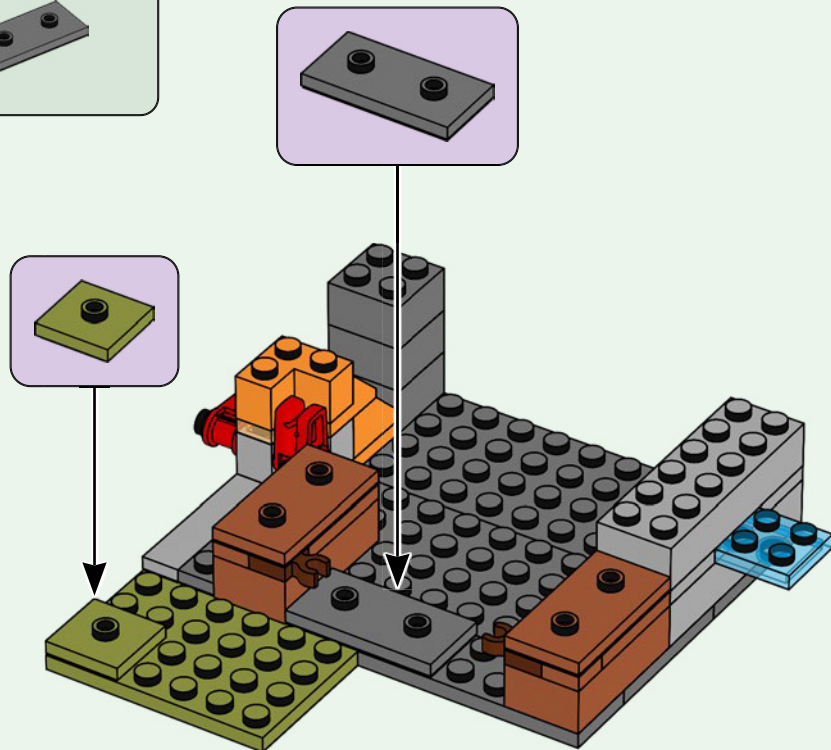

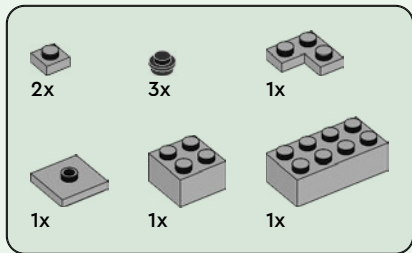

19

1

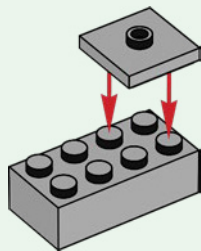

2

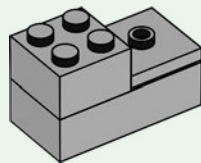

3

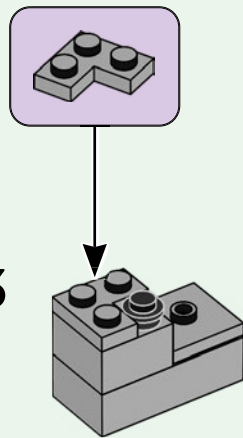

4

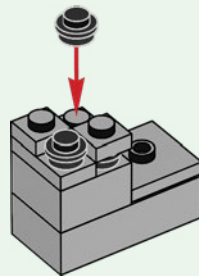

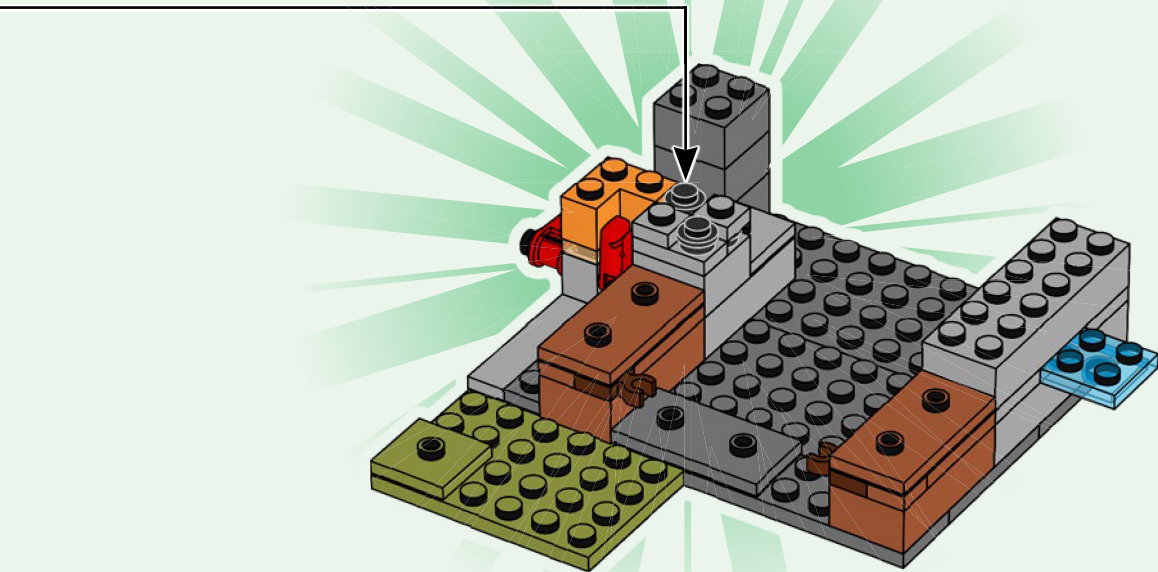

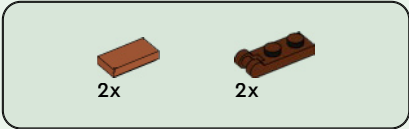

20

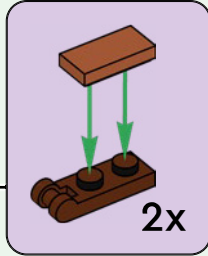
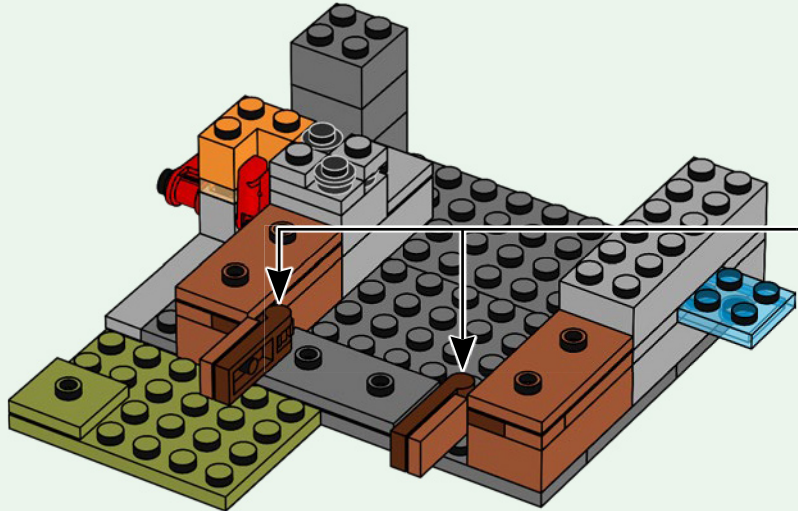

21

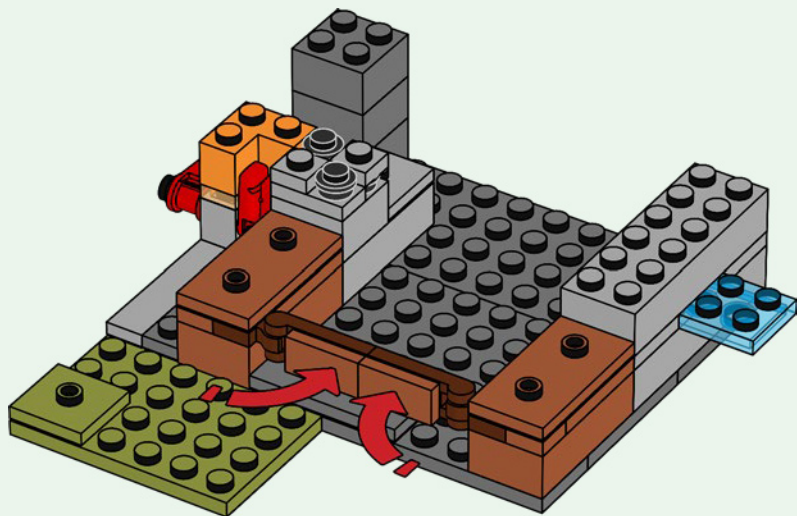

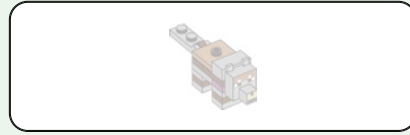

22

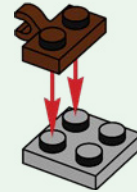



1x



1x

23

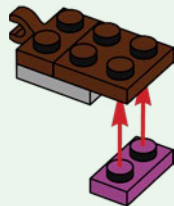

2x



4x

24

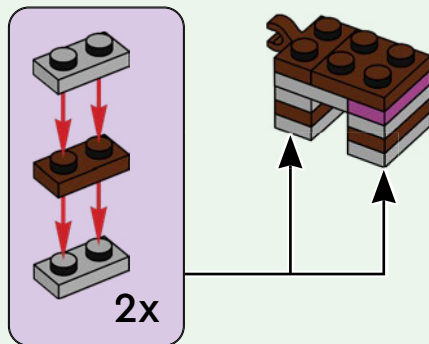

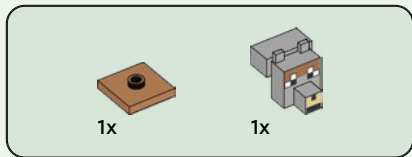

25

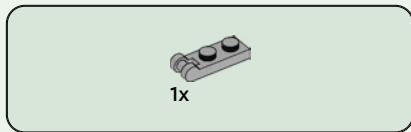
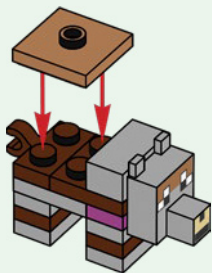

26

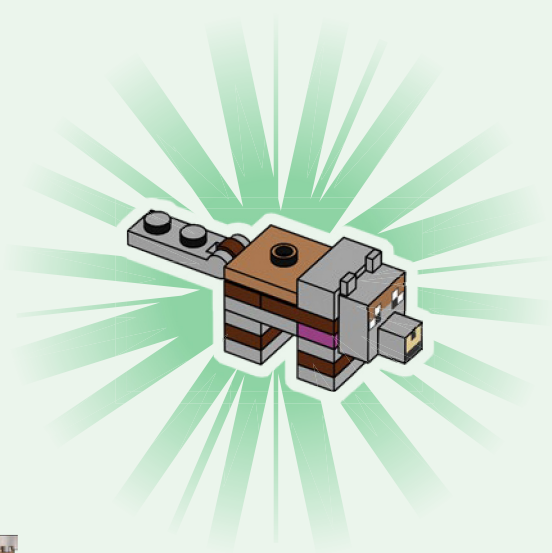



2x

27

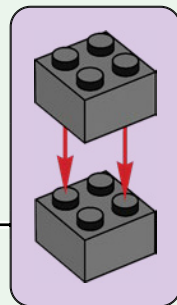
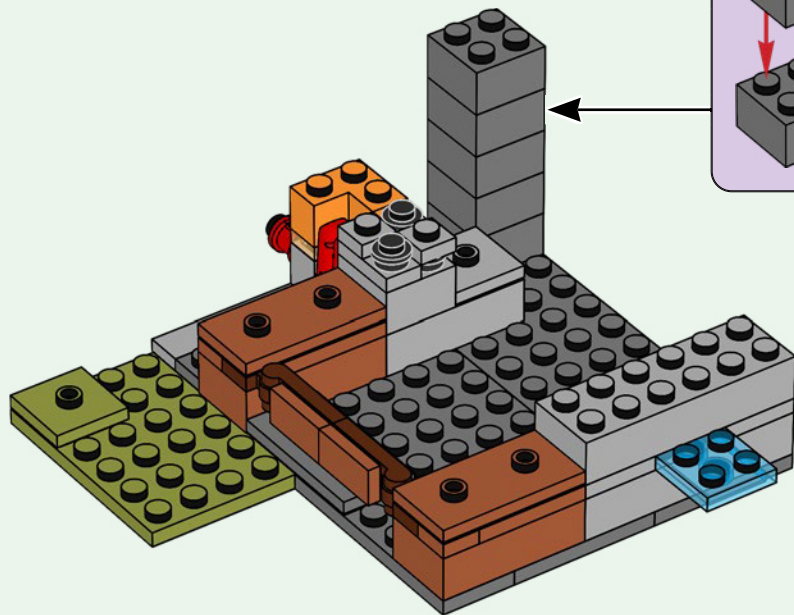

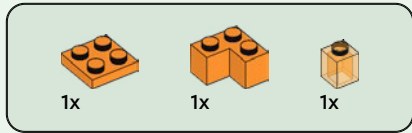

28

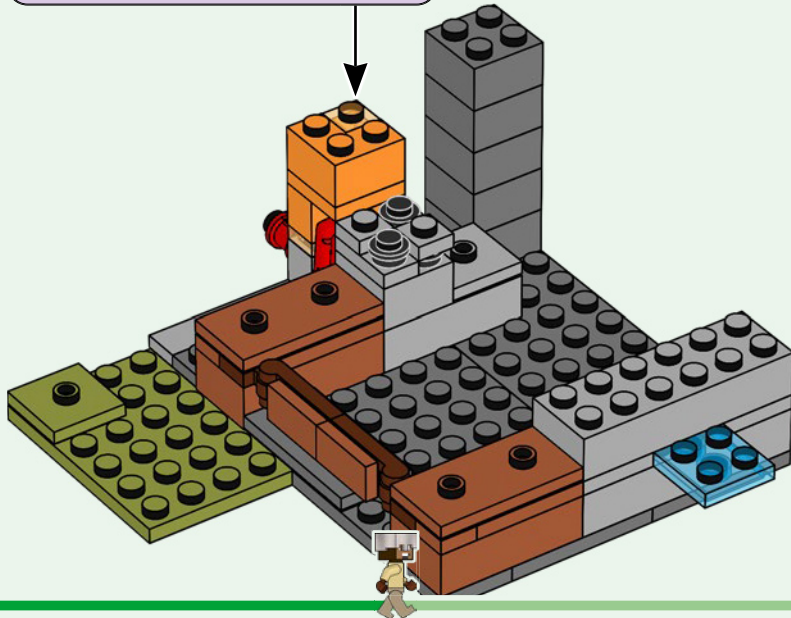
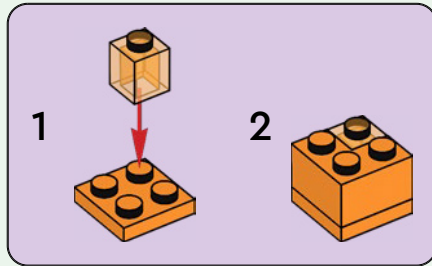

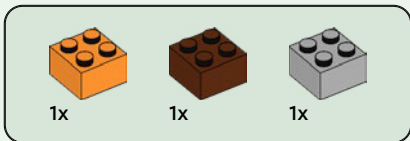

29

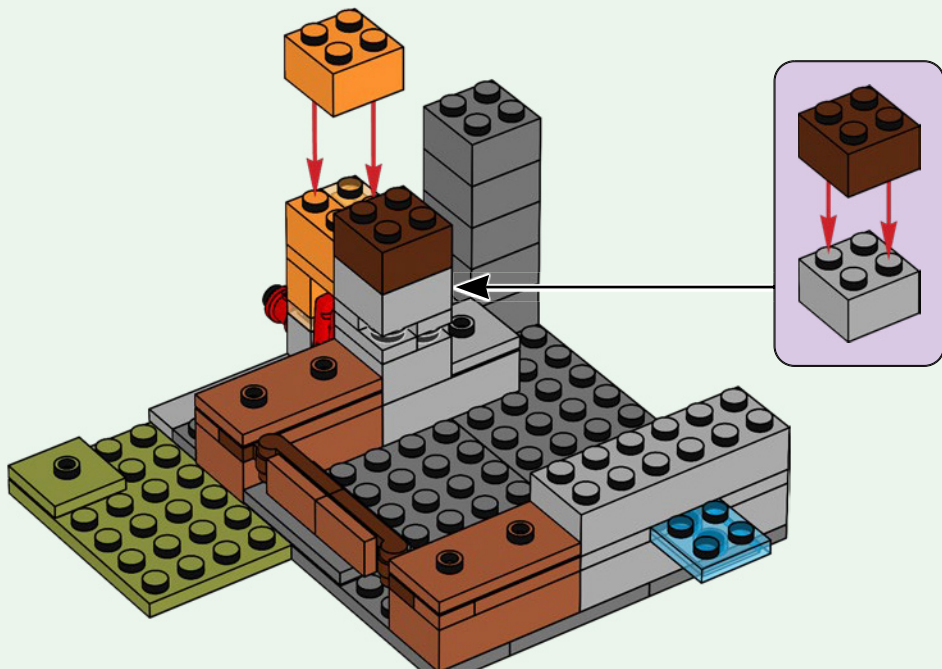

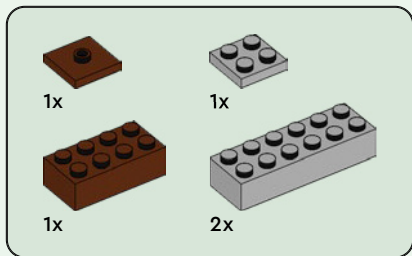

30

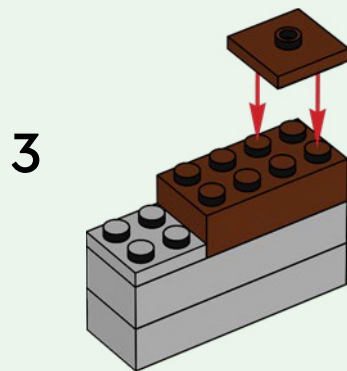
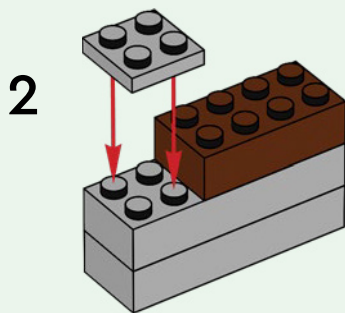
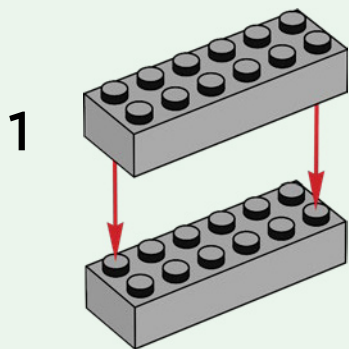

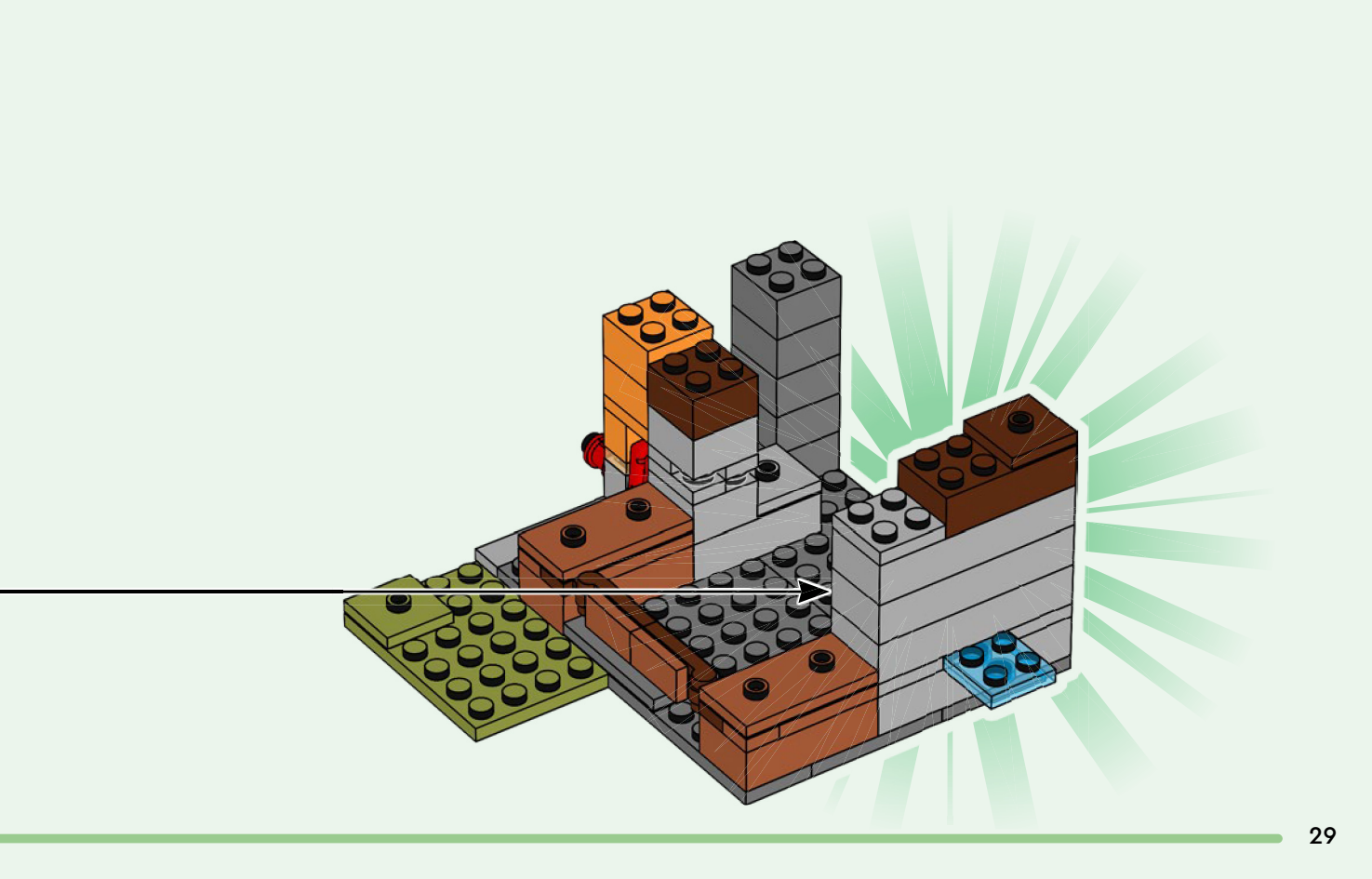

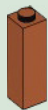

2x

31

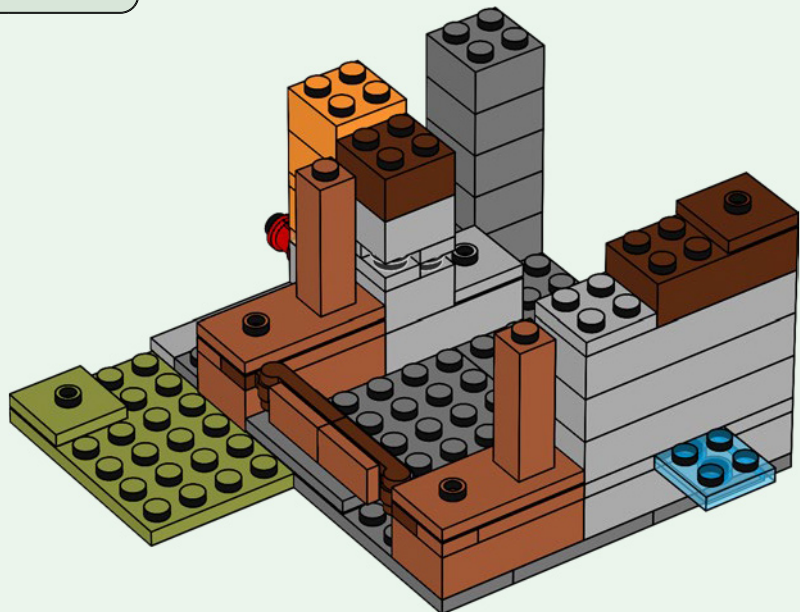



2x

32

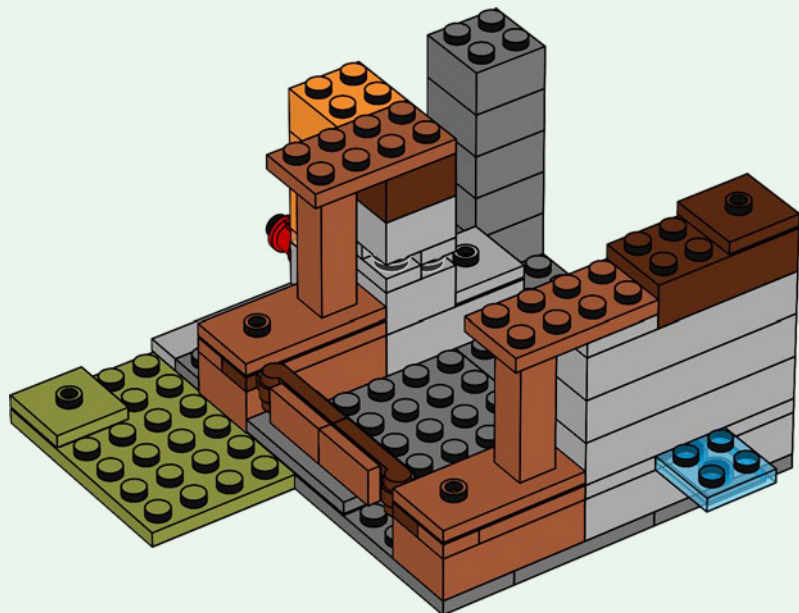

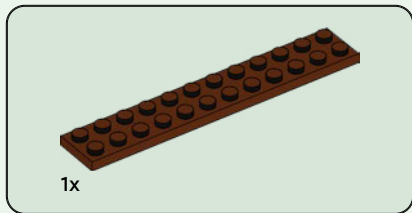

33

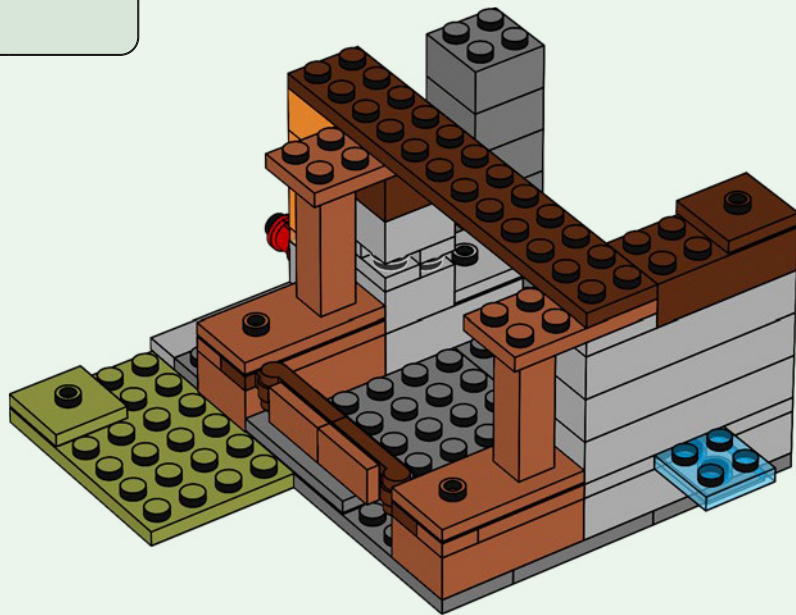

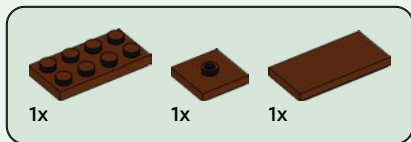

34

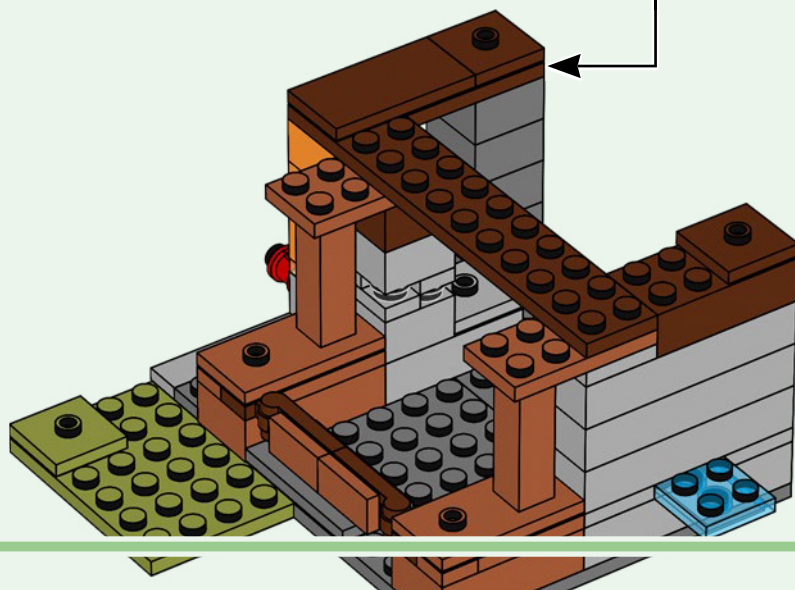
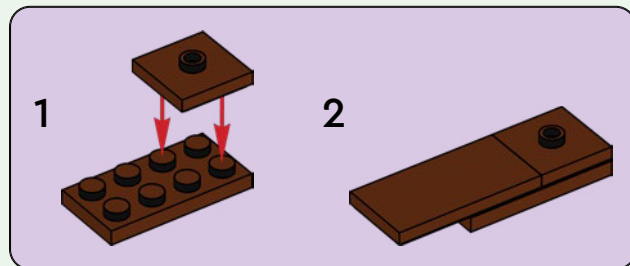



3x

35

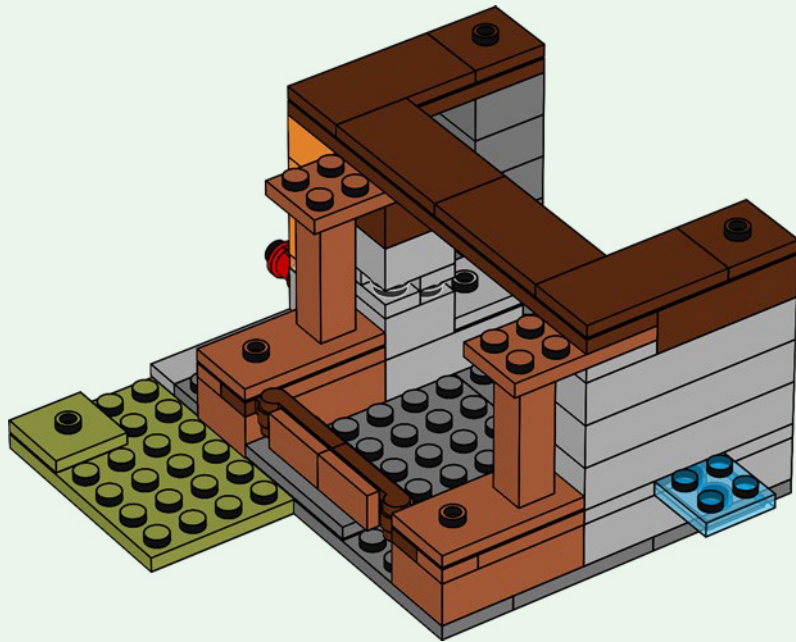

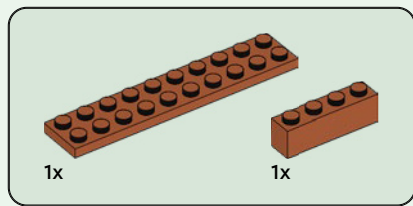

36

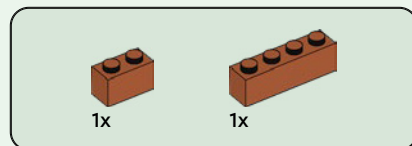
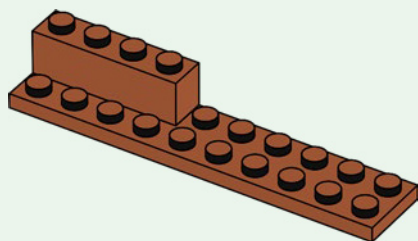

37

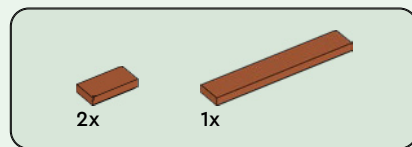
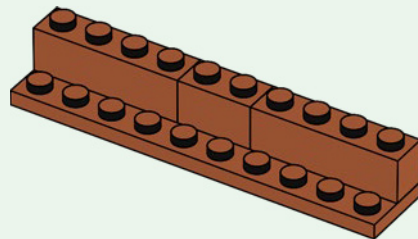

38

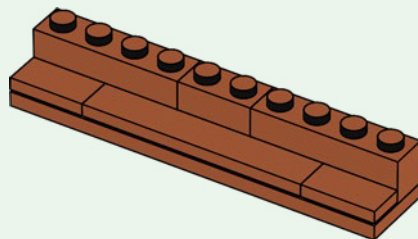

39

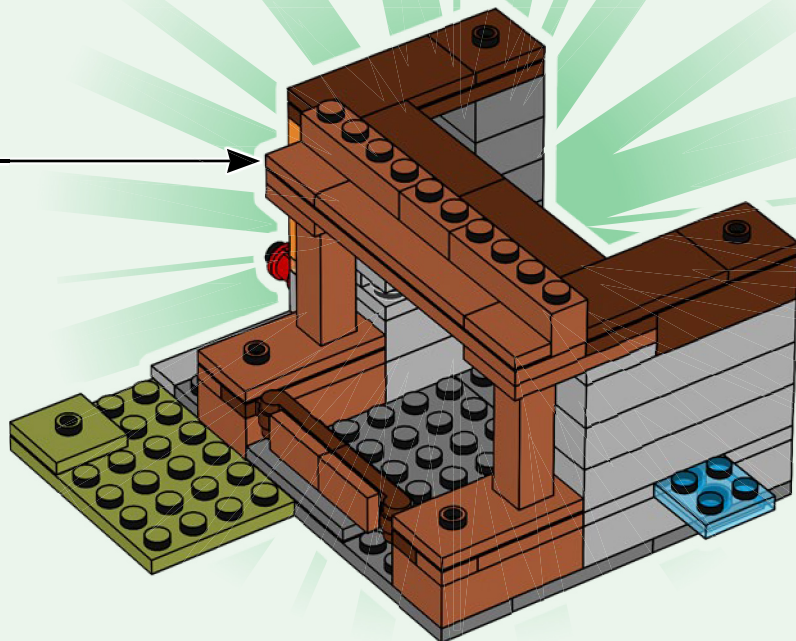

40

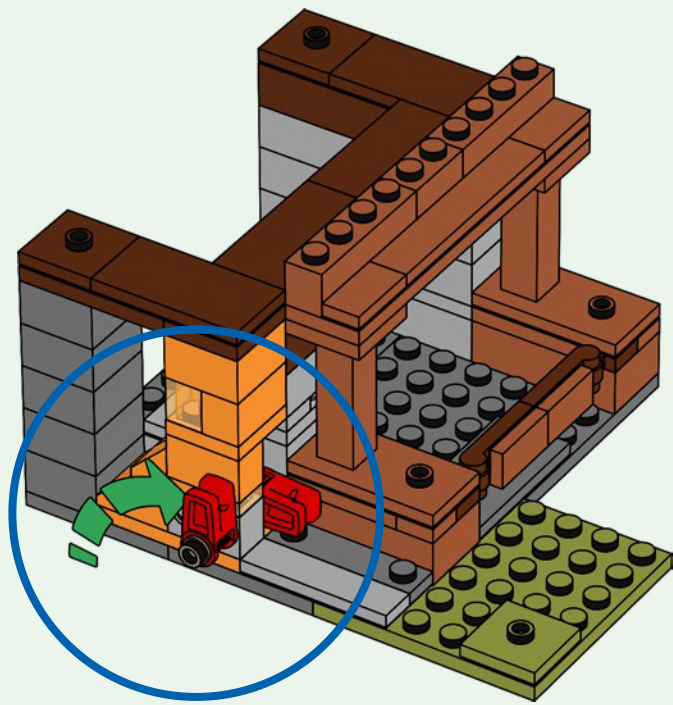

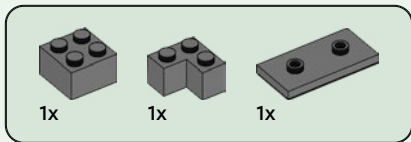

41

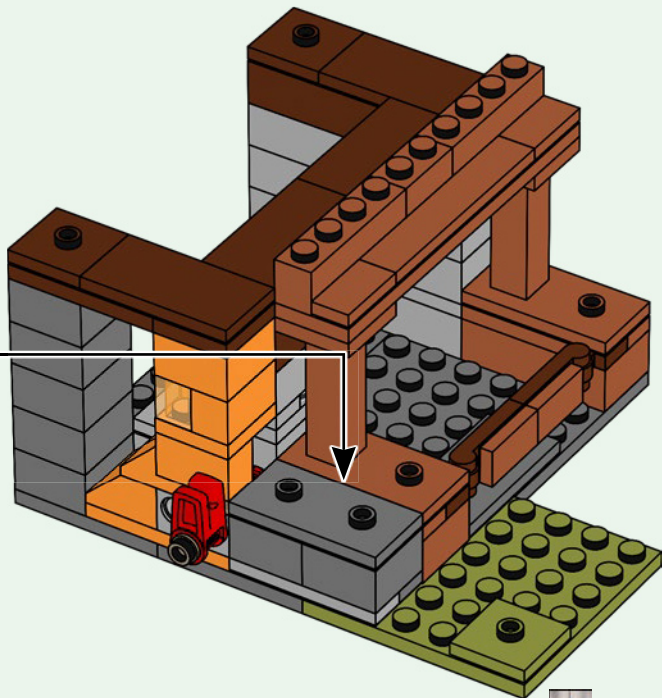
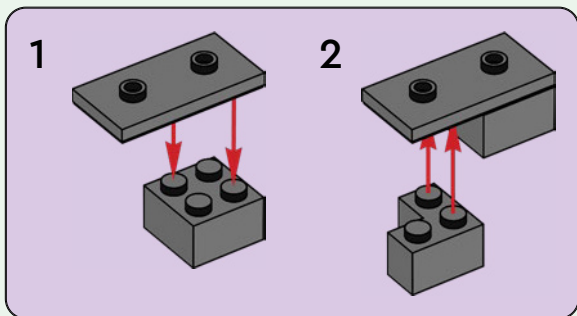



3x



1x

42

1

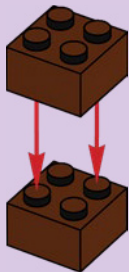

2

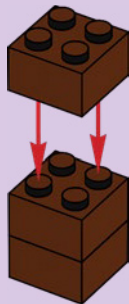

3

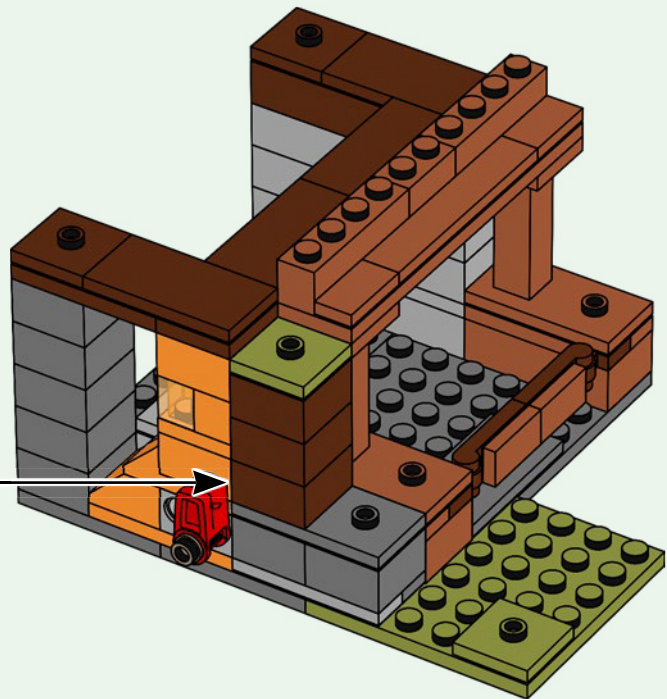
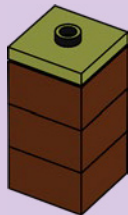

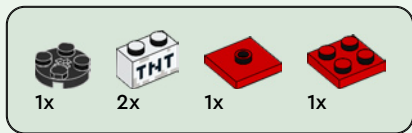

43

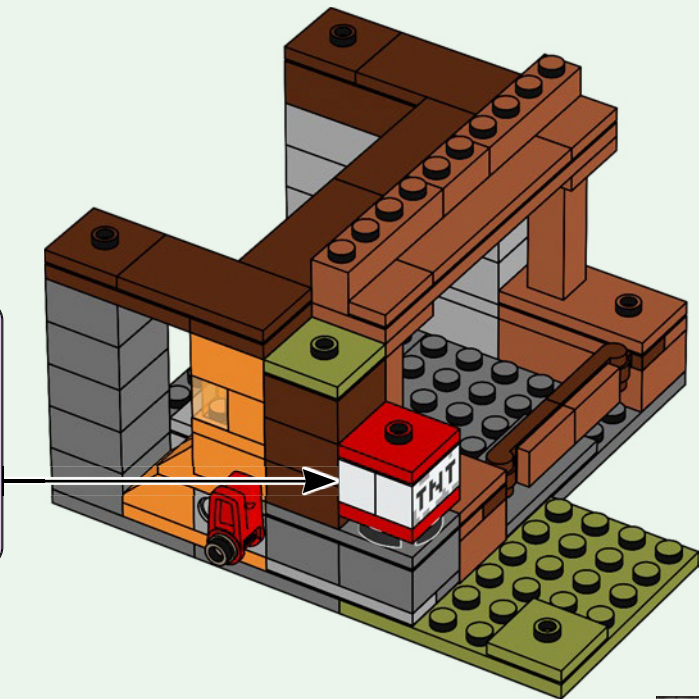
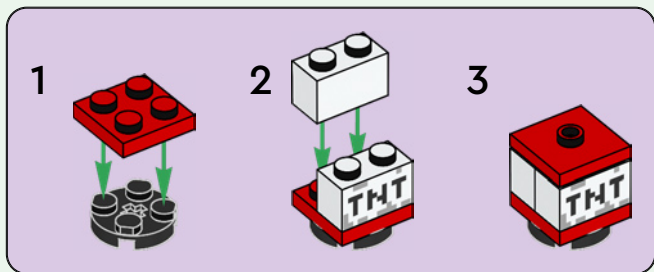

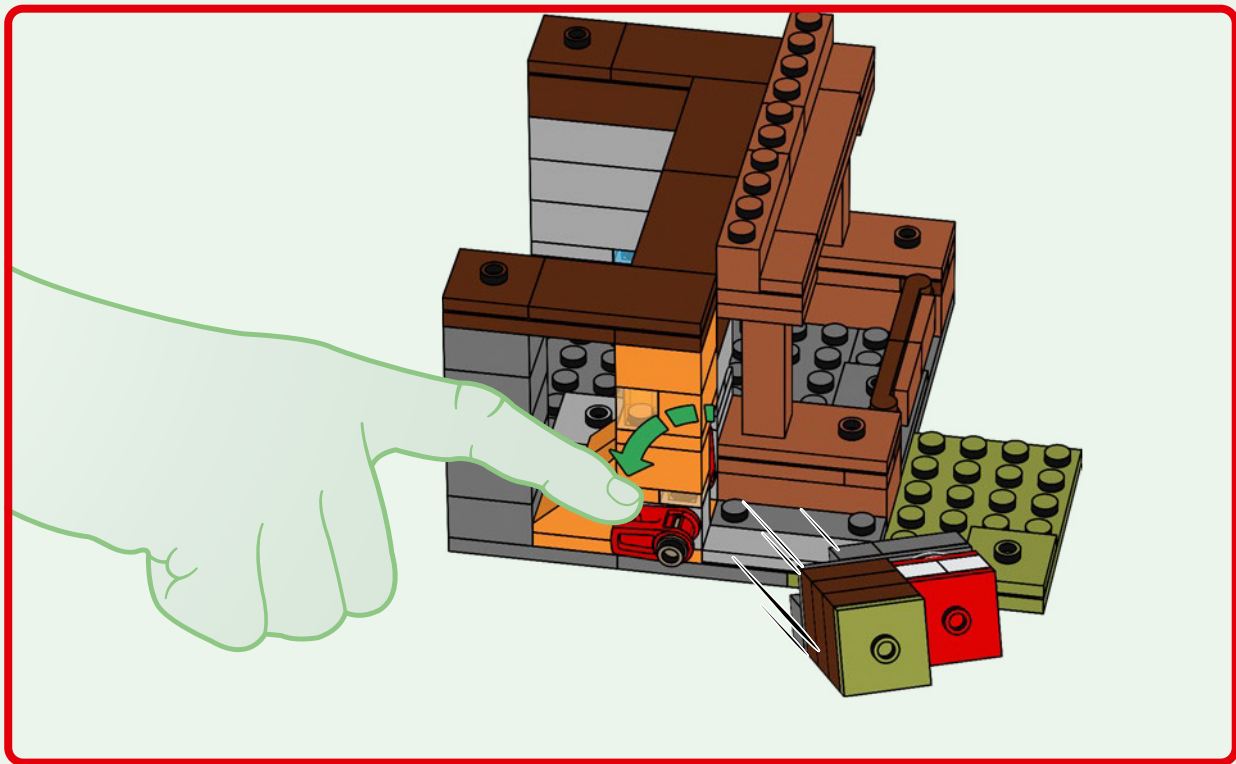

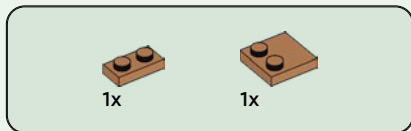

44

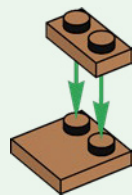



1x

45



1x

46



1x

47





1x

48



1x

49

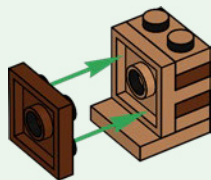

2x

50

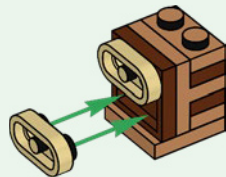



1x

51



1x

52



1x

53

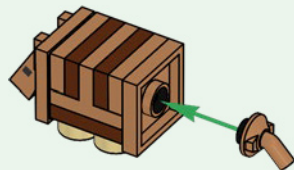

2x

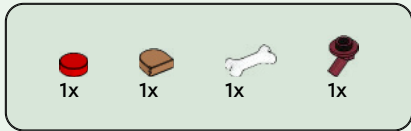

54

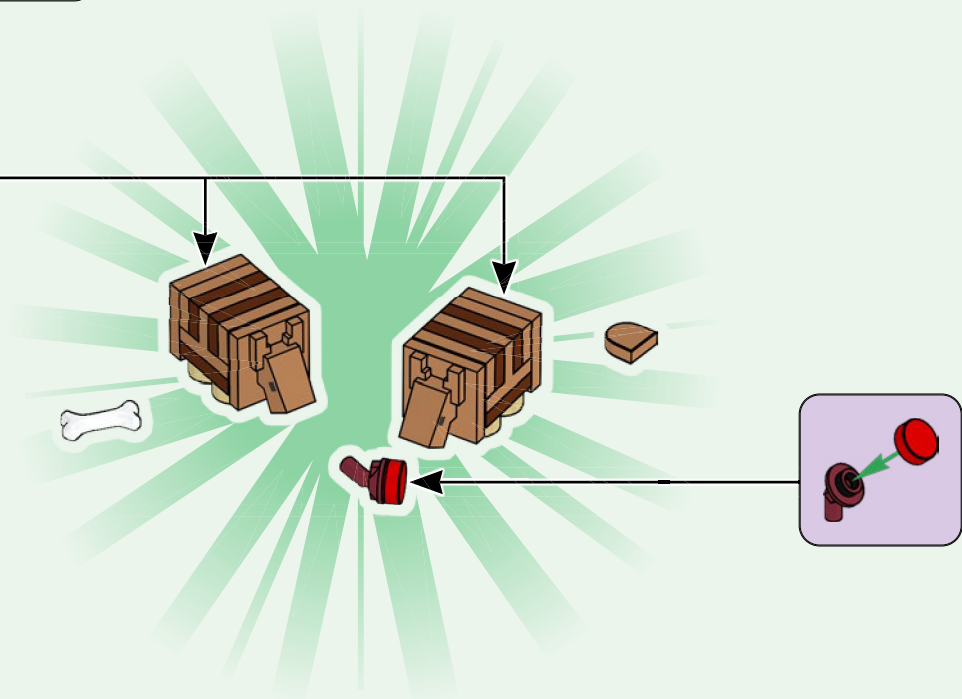



4x



2x



2x

55

1



2



3



2x

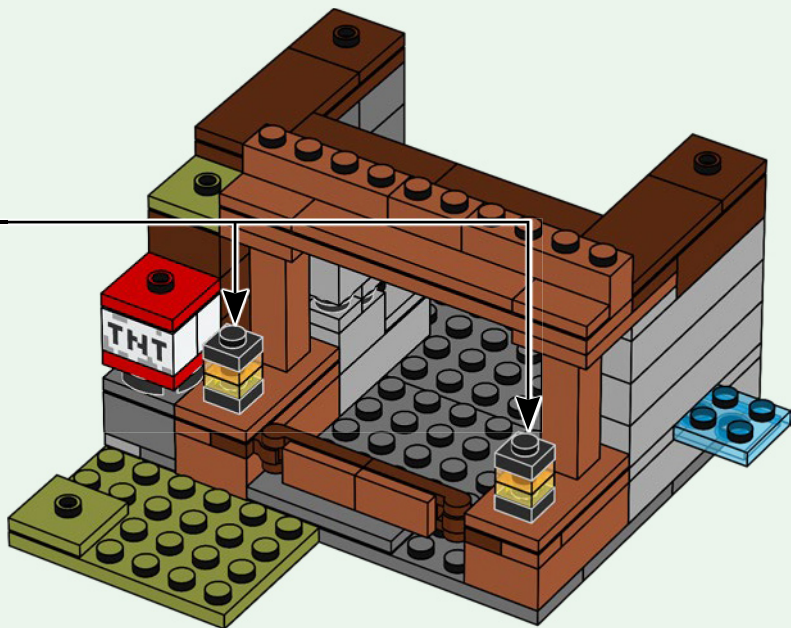

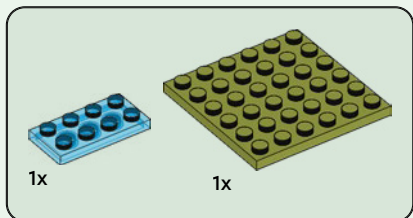
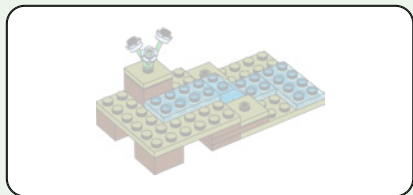

56

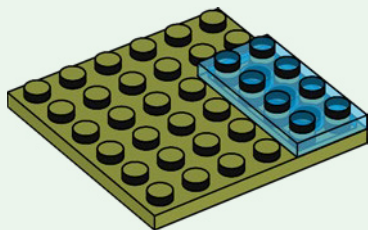



1x

57

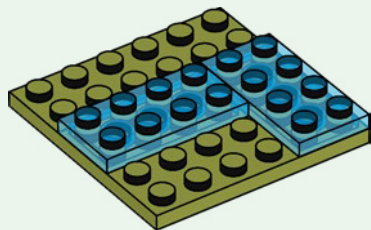

1x

58

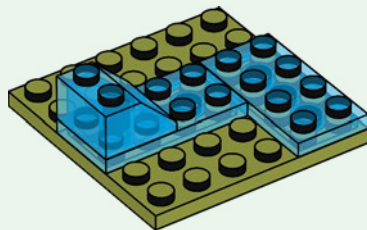

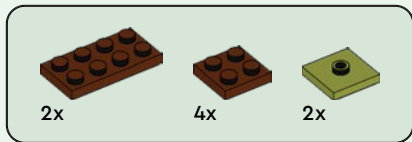

59

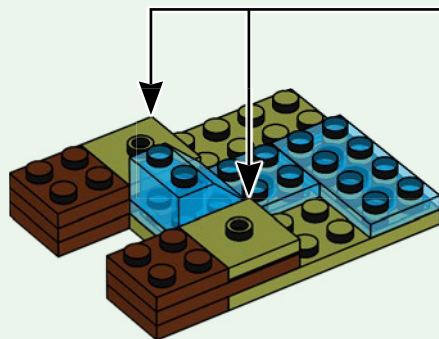
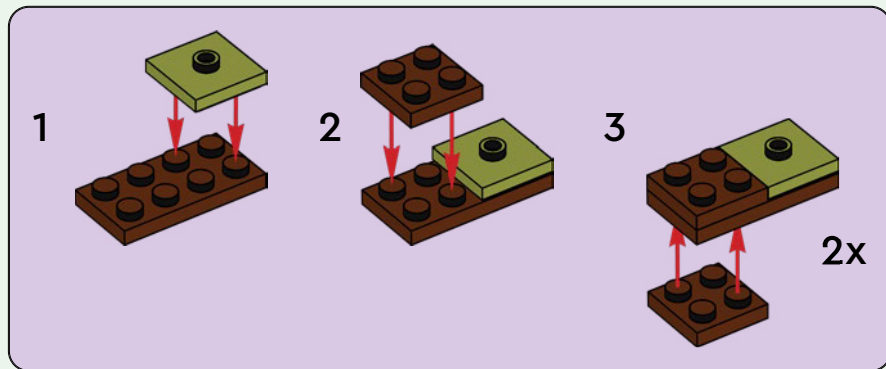

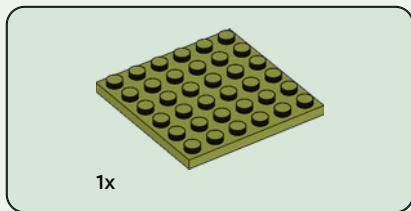

60

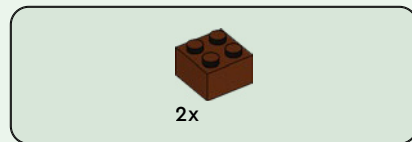
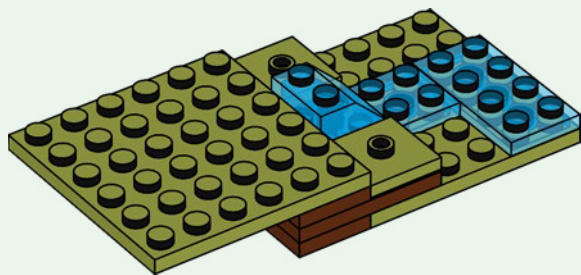

61

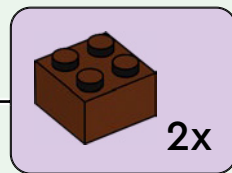
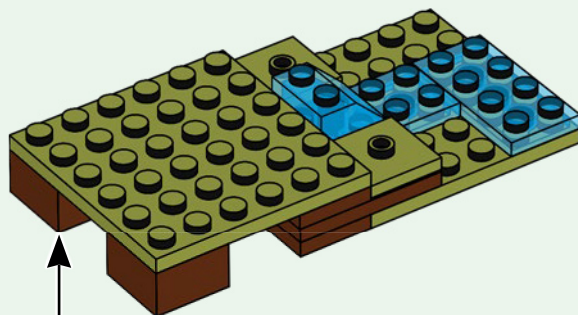



1x

62

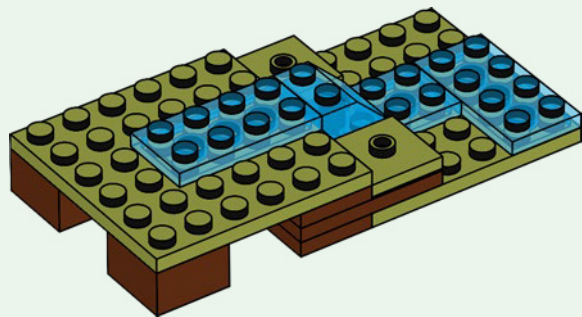

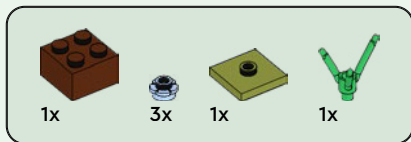

63

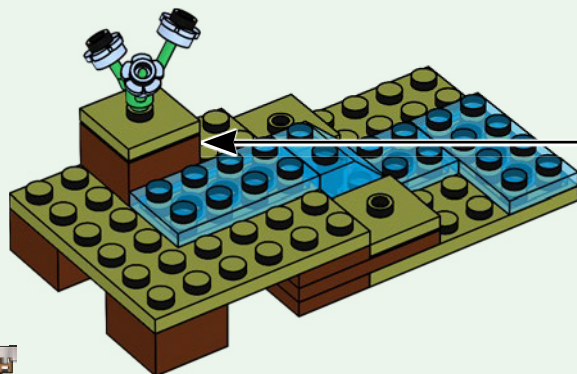
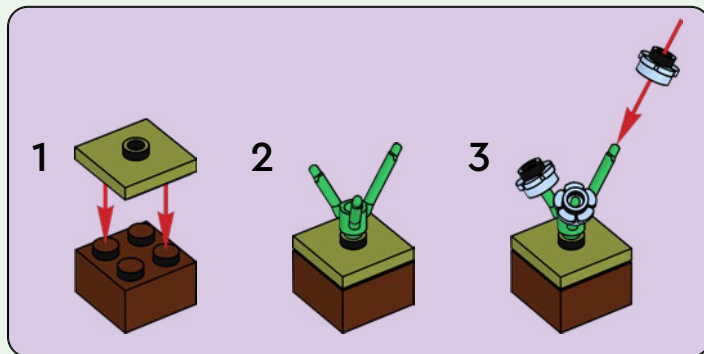

64

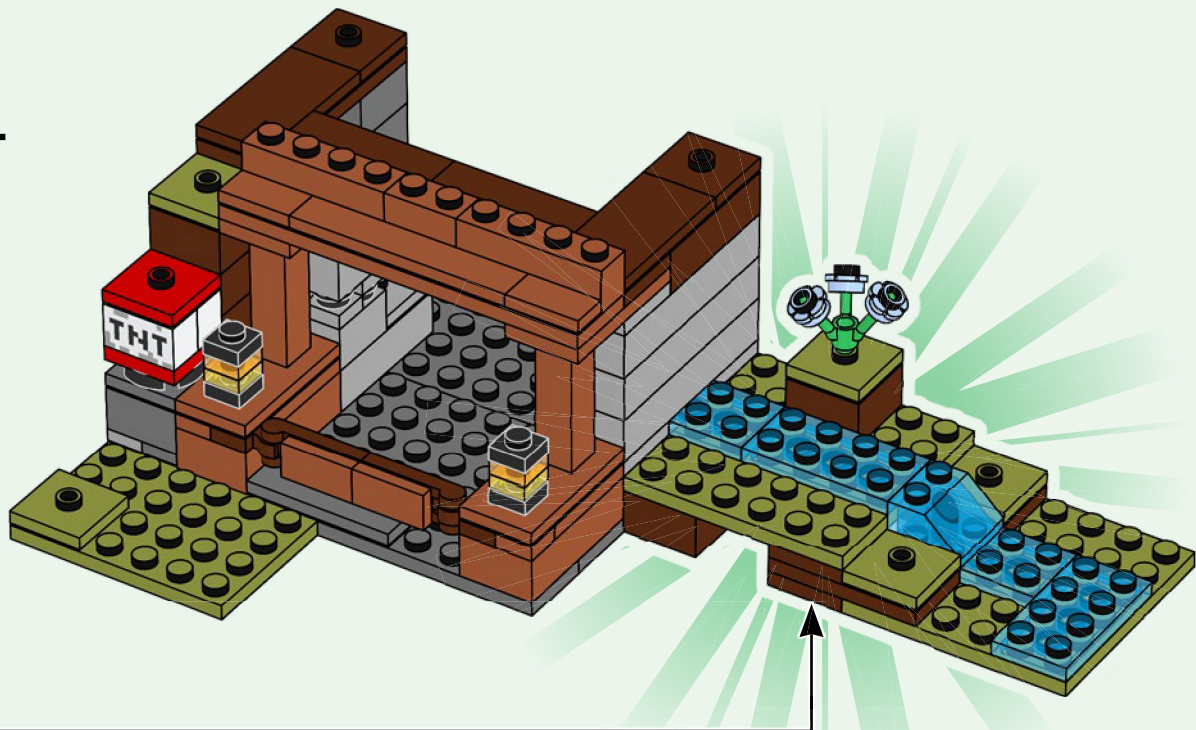



2x



1x

65



1

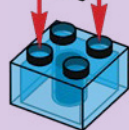
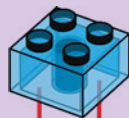

2

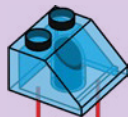

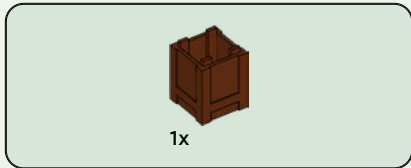

66

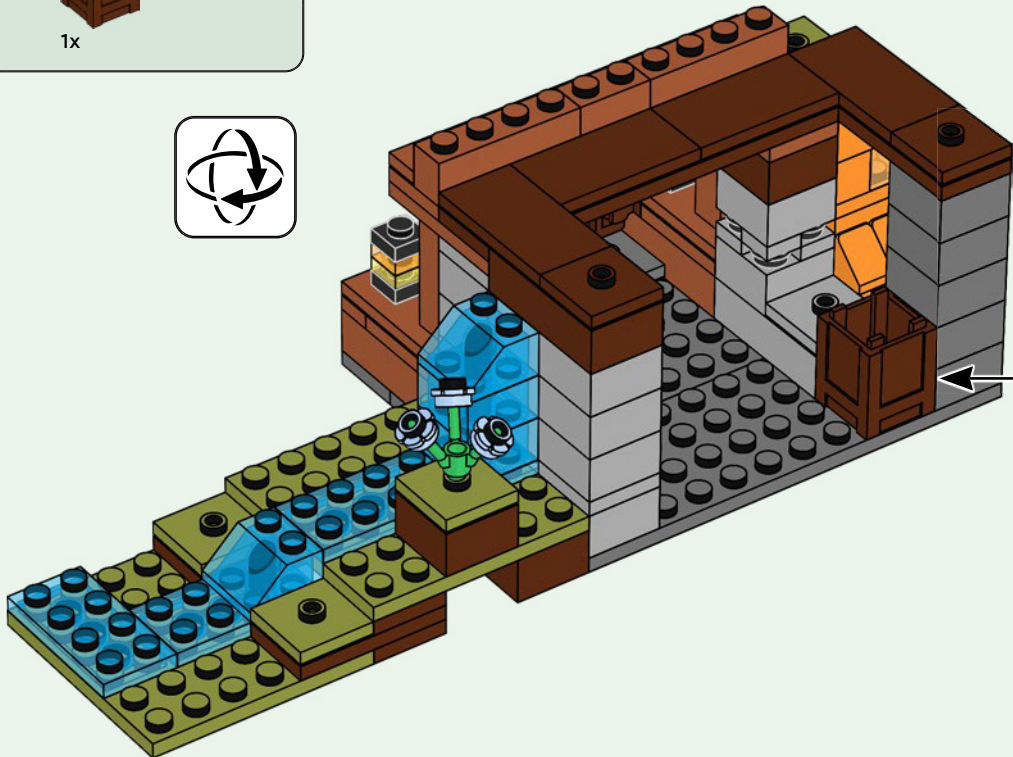

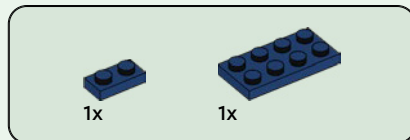
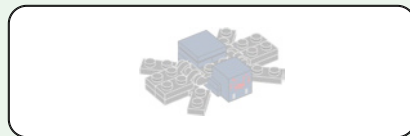

67

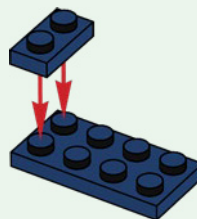



2x

68



2x

69

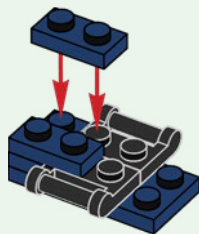

1x

70

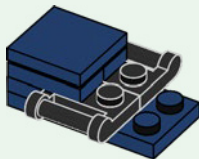

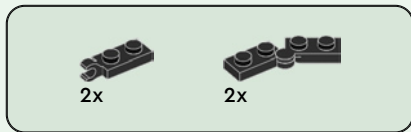

71

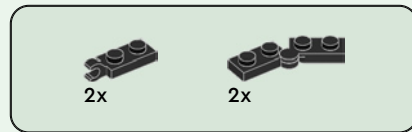
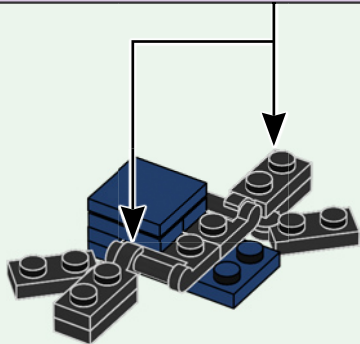
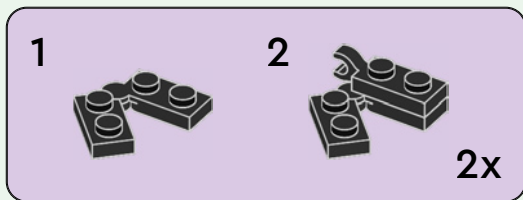

72

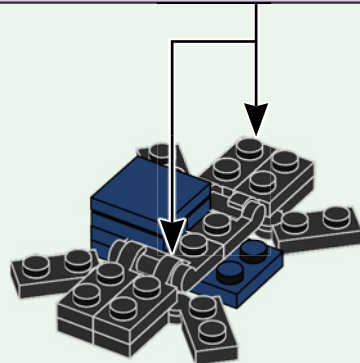
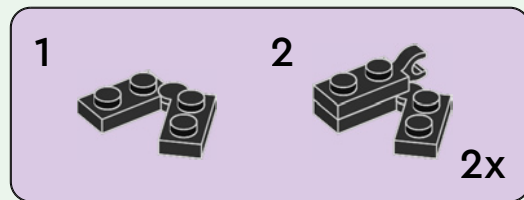



1x

73

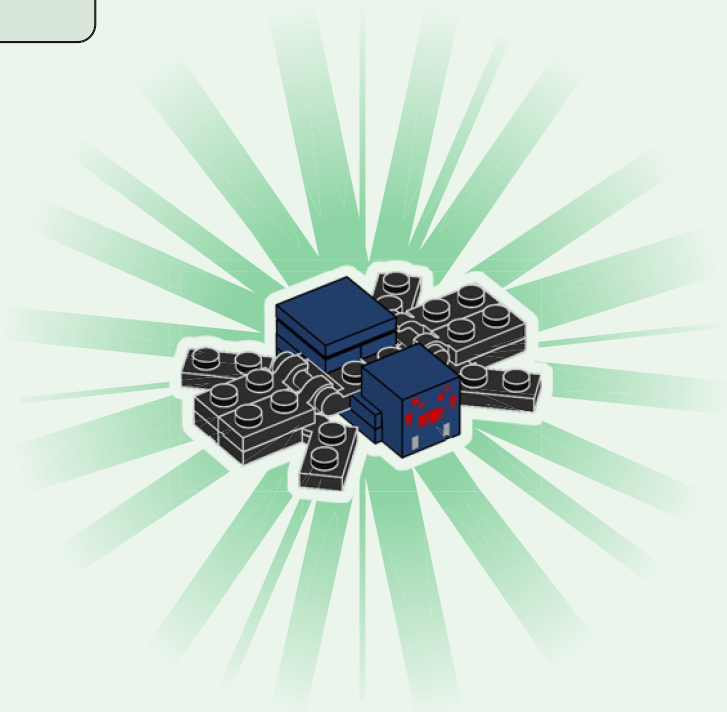

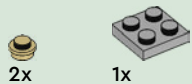

2x

1x

74

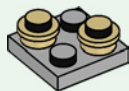

2x

75

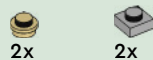

2x

2x

76

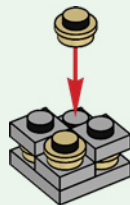

1x

77

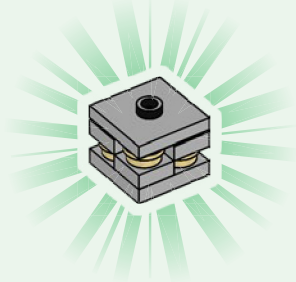

78

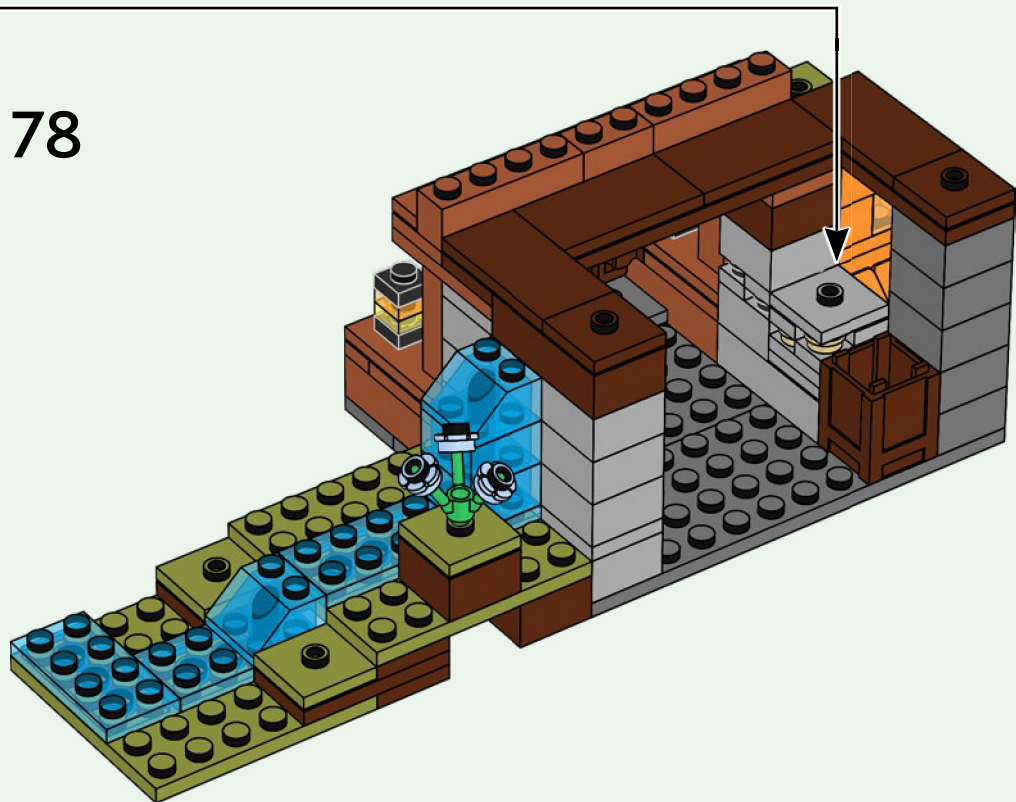



1x



2x

79



2x

80



2x



2x

81

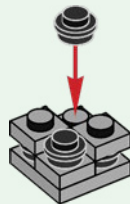

1x

82

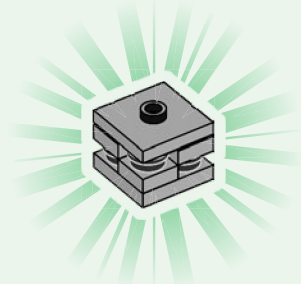

83

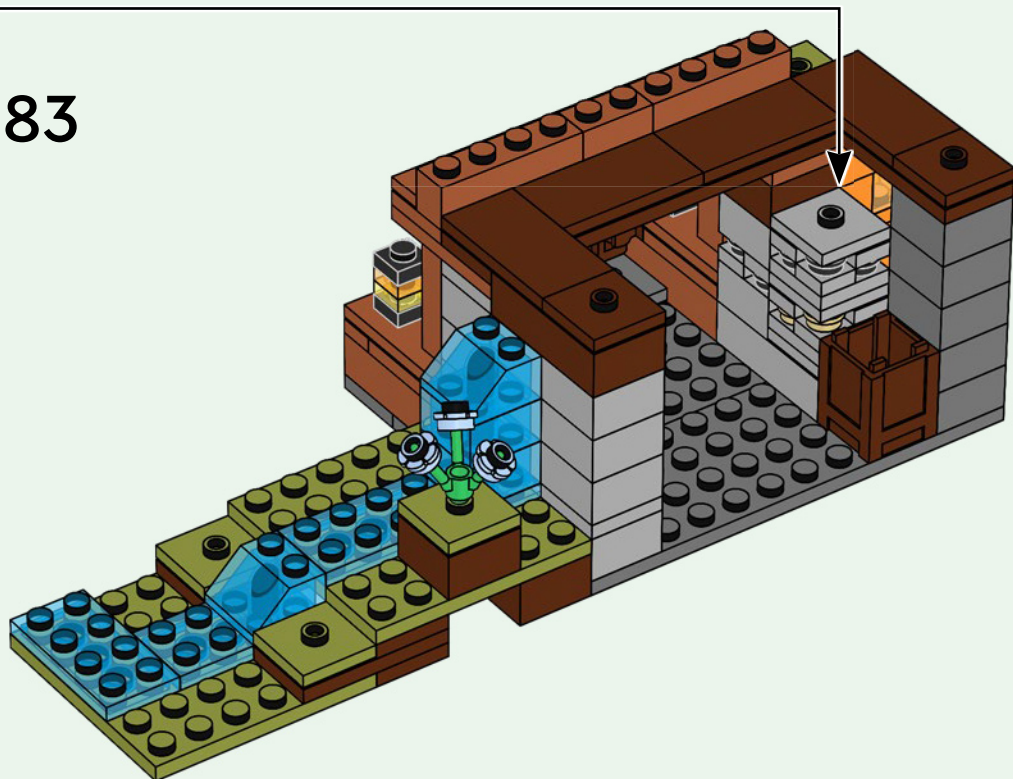



1x



1x

84

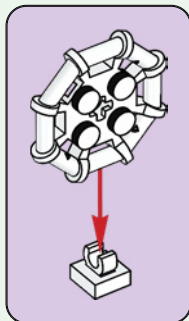

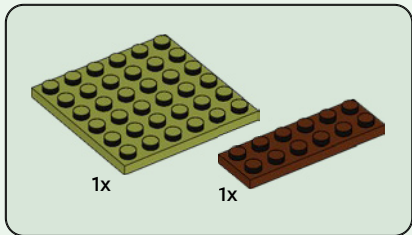
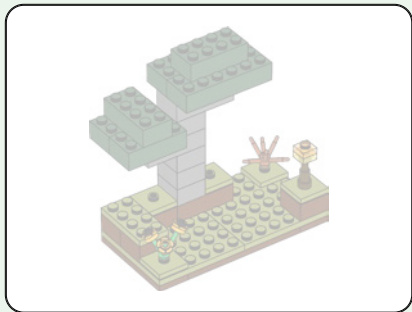

85

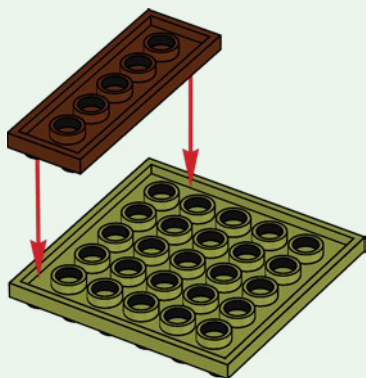

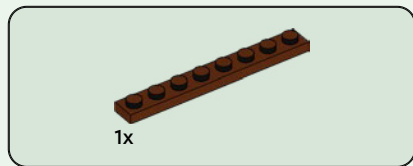

86

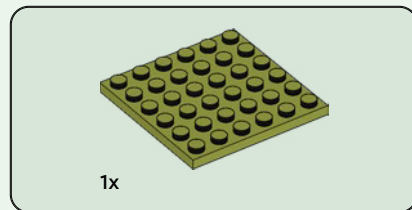
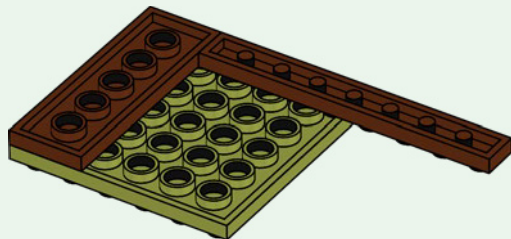

87

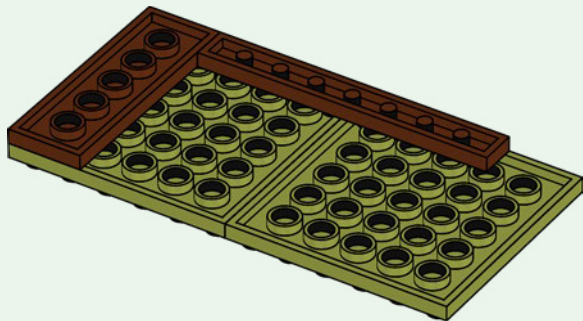

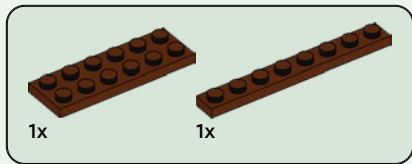

88

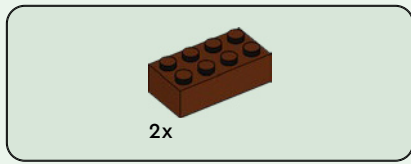
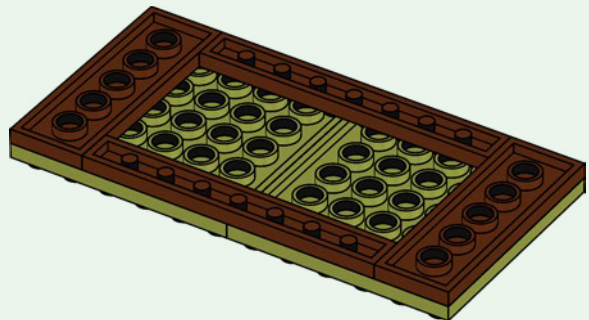

89

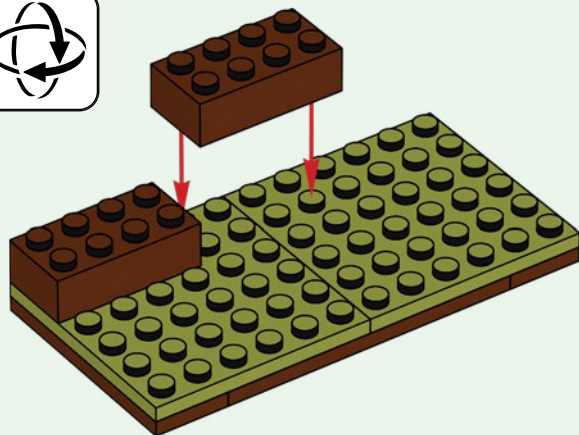

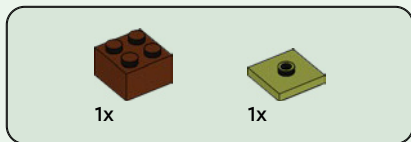

90

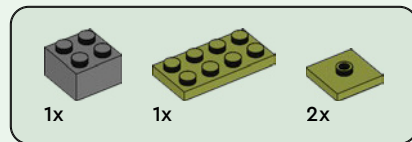
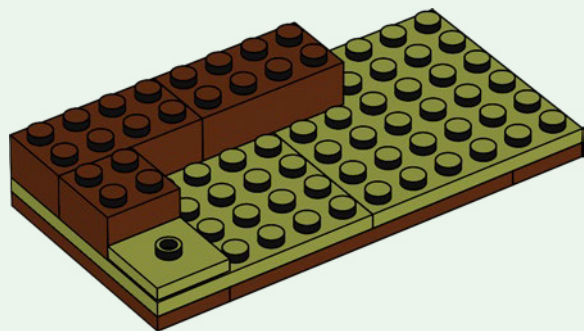

91

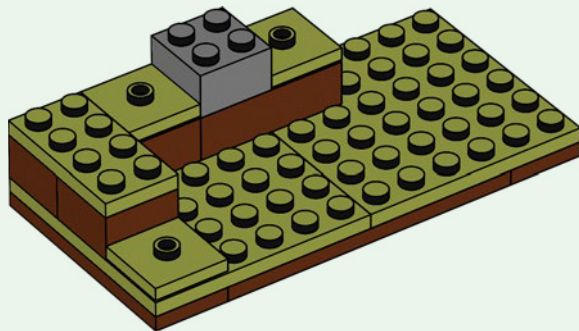

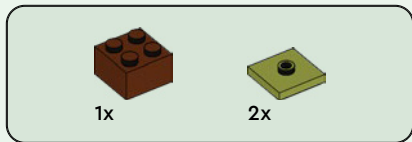

92

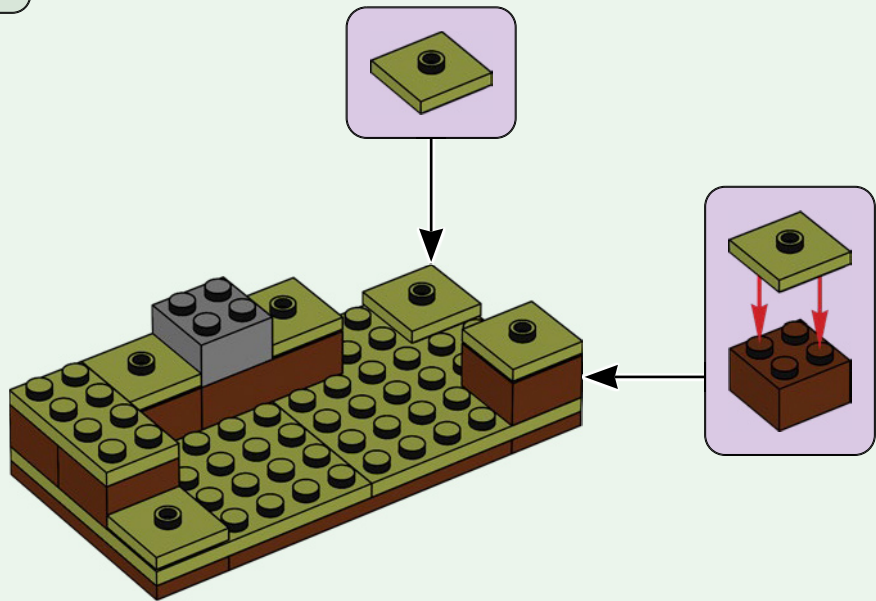

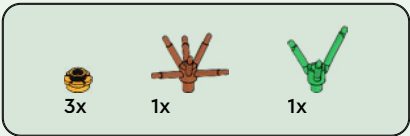

93

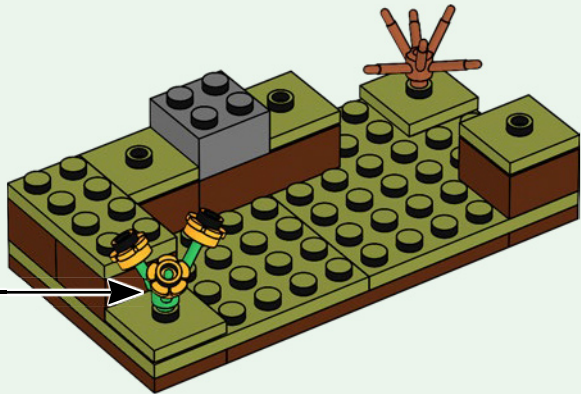
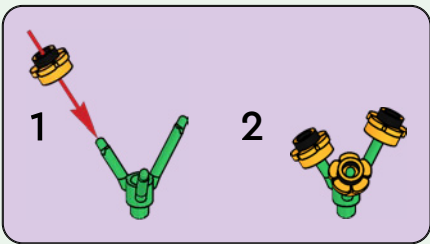



2x

94

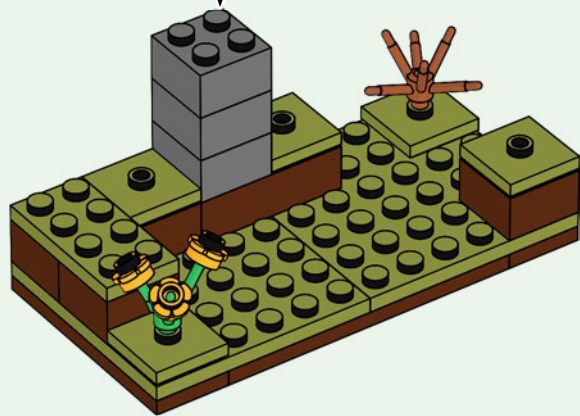
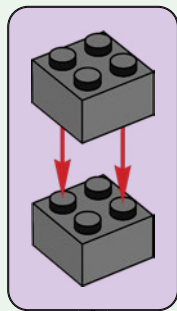

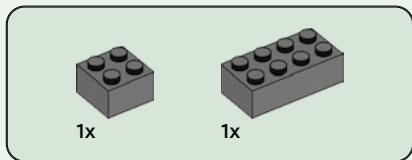
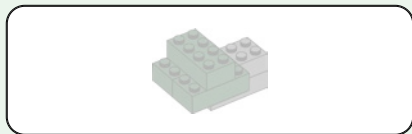

95

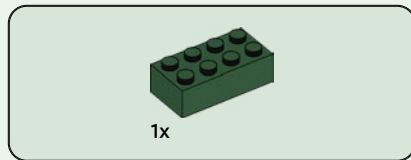
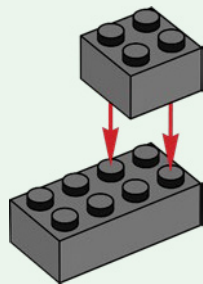

96

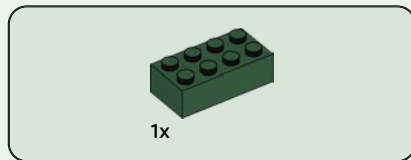
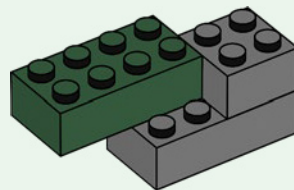

97

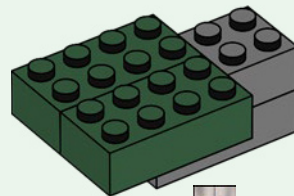

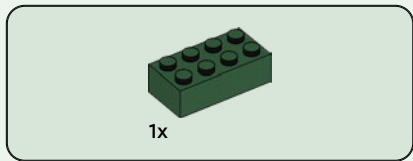

98

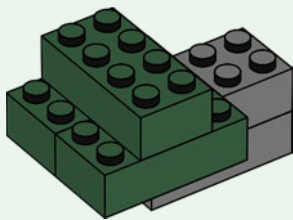

99

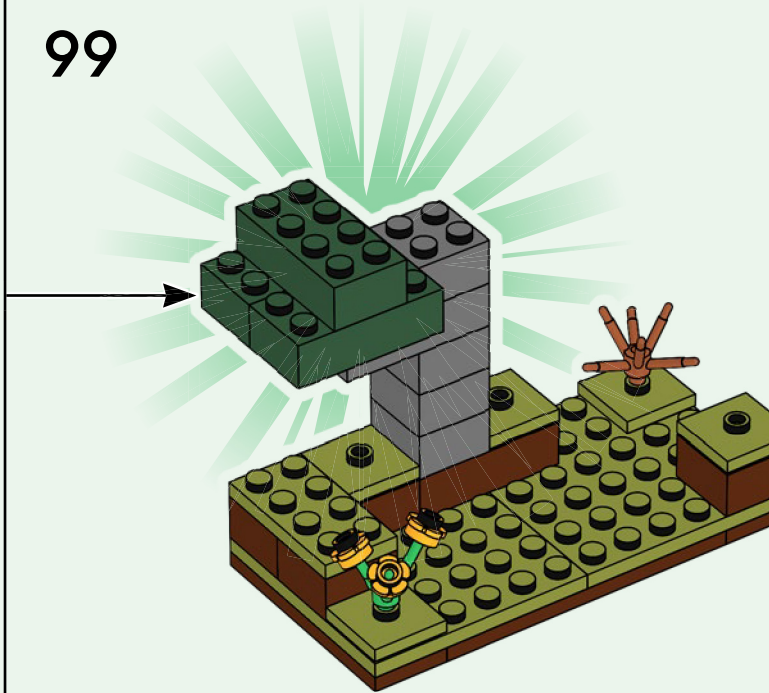

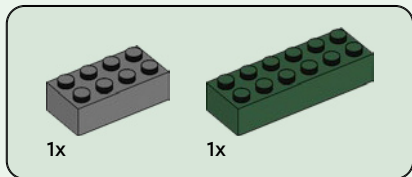
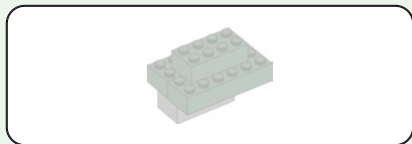

100

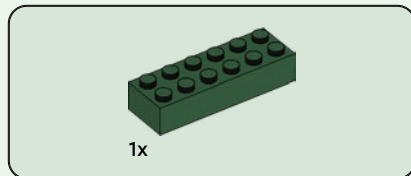
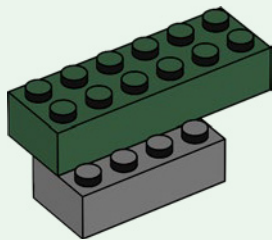

101

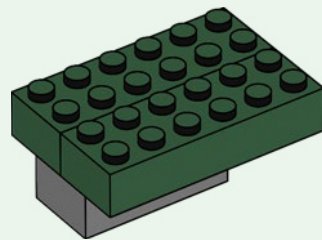

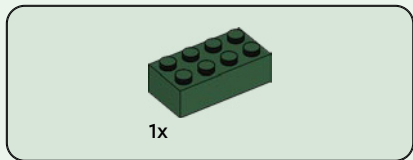

102

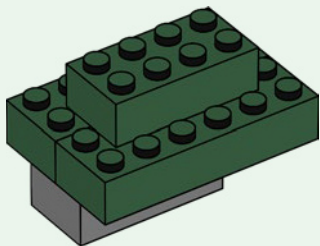

103

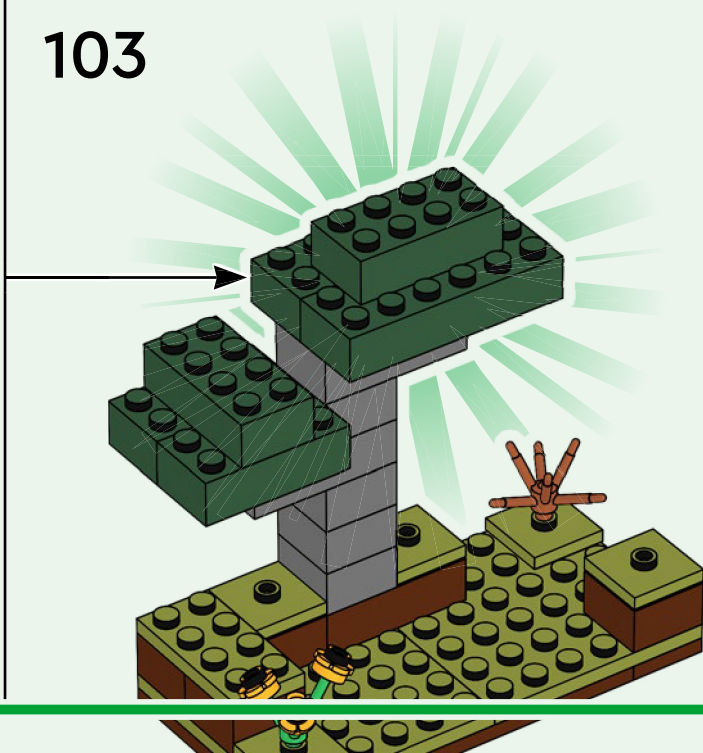



1x



1x



1x

104

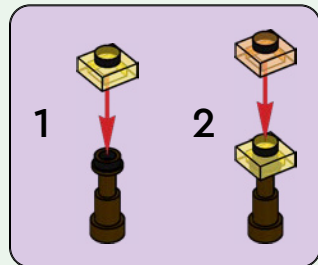
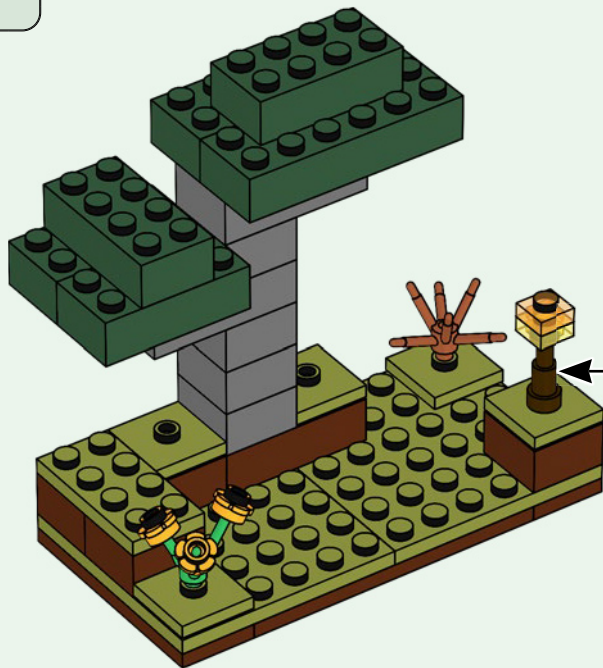

1

2



105

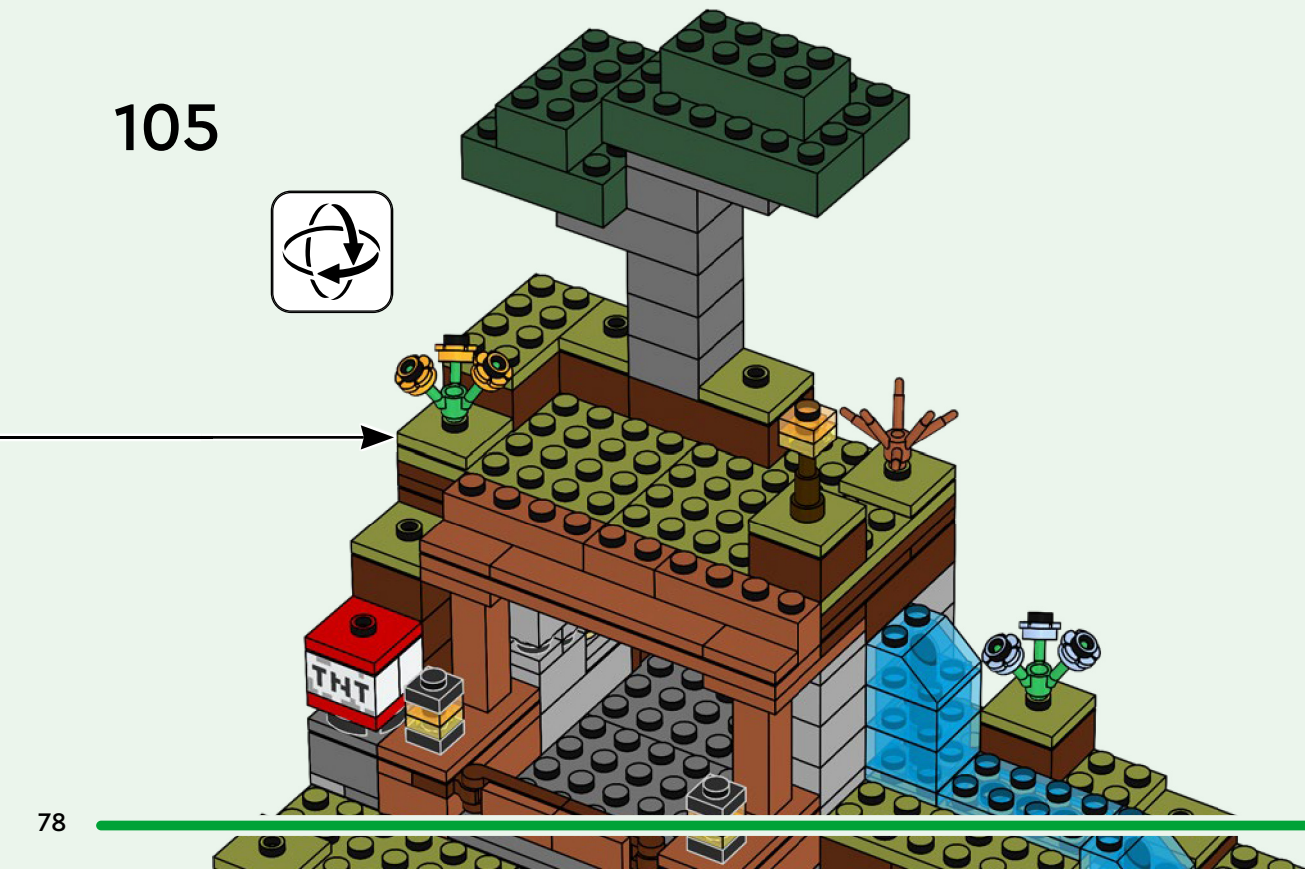





MINECRAFT



21269



21268



21267





1x
6348055



1x
6360202



2x
6097028



1x
6009016



4x
4161734



4x
6212758



1x
6529033



1x
6284574



2x
6263067



1x
302221



1x
6126048



7x
614126



4x
302426



1x
403226



4x
6336989



2x
4225201



4x
6416444



2x
6269971



2x
6397875



2x
6186012



4x
4614158



1x
4579659



1x
6269941



2x
6359717



2x
6223040



2x
6288614



2x
6487946



2x
4535928

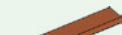

1x
6359696



1x
6351327



2x
6514091



2x
6514101



4x
6513941



3x
6513966



2x
6445444



1x
4153825



1x
4159007



2x
6212079



1x
4118828



1x
4158355



1x
6103415



1x
4524098



1x
6031821



3x
4528981



1x
6528886



1x
4205004



1x
4667595



4x
4260493



2x
6215657



1x
6510194



1x
6240550



4x
6513961



3x
6209681



2x
6337003



6x
4211150



1x
6313124



2x
4565394



9x
4211210



7x
4216695



1x
4520638



2x
6102975



3x
4211201



4x
4579690



3x
4211186

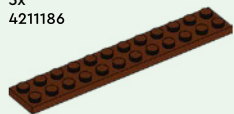

1x
4225700



2x
4216945



2x
4211247



10x
4211399



1x
4211389



1x
4211541



4x
4211398



1x
6528882



6x
4211397



3x
6126082



2x
4211387



1x
4211353



1x
4515369



1x
4211356



1x
4211385

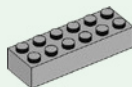

4x
4211795



3x
6209683



1x
6528879



1x
4538950



2x
6510192



1x
6349124



2x
6528881



4x
6218360



2x
6313599



2x
6528998



3x
6102994



1x
6104264



1x
6214216



10x
6212080



1x
6020144



5x
6528997



10x
4211060



1x
4211109



1x
6257592



2x
6307616



2x
4211085



1x
4211002

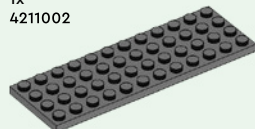

2x
4210706



 [LEGO.com/service](https://www.LEGO.com/service)

YOU COULD
WIN

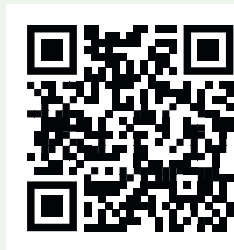

Scan this QR code or go to
LEGO.COM/PRODUCTFEEDBACK and give
us your short feedback about this LEGO® set
for a chance to win a cool LEGO prize.

Terms and Conditions apply*

EN: YOU COULD WIN. Terms and Conditions apply* **DE: Du könntest GEWINNEN.** Es gelten die Teilnahmebedingungen* **FR: Tu pourrais GAGNER.** Des conditions s'appliquent* **IT: Potresti VINCERE tu.** Termini e condizioni sono applicabili* **ES: Puedes GANAR.** Aplican términos y condiciones* **PT: Poderá GANHAR.** Aplicam-se termos e condições* **ZH: 轻松获奖. 条款和条件适用*** **PL: Szansa na WYGRANĄ.** Obowiązują warunki korzystania* **CS: Máte šanci VYHRÁT.** Platí všeobecné smluvní podmínky* **SK: Máte šancu VYHRAŤ.** Platia všeobecné zmluvné podmienky* **HU: TE IS NYERHETSZ.** Felhasználási feltételek érvényesek* **RO: Ai putea CÂȘTIGA.** Se aplică termenii și condiții* **BG: Можете да СПЕЧЕЛИТЕ.** Има определени правила и условия* **LV: Tu vari LAIMĒT.** Ir spēkā noteikumi un nosacījumi.* **ET: Sul on võimalus VÕITA.** Kehtivad tingimused* **LT: Jūs galite LAIMĖTI.** Taikomos sąlygos*

*[LEGO.com/productfeedback-terms](https://www.lego.com/productfeedback-terms)

LEGO and the LEGO logo are trademarks of the LEGO Group. ©2025 The LEGO Group.

© 2025 Mojang AB. All Rights Reserved. Minecraft, the Minecraft logo, the Mojang Studios logo and the Creeper logo are trademarks of the Microsoft group of companies.

6556011