



Harry Potter



76439



1

2

3



LEGO® Builder



LEGO.com/sustainable-packaging



FR
DONNEZ
OU
RECYCLEZ



OU



OU



ASSOCIATION

MAGASIN

DÉCHÈTERIE

Adresses sur quefairedemesdechets.fr

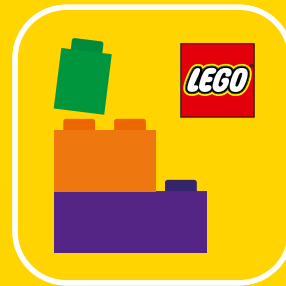

🔍 LEGO® Builder

BUILDER

Download on the
App Store

GET IT ON
Google Play

腾讯应用宝
安卓应用商店

Apple and the Apple logo are trademarks of Apple Inc., registered in the U.S. and other countries and regions. App Store is a service mark of Apple Inc. Google Play and the Google Play logo are trademarks of Google LLC. Tencent and the Tencent logo are trademarks of Tencent Inc.

🔍 LEGO.com/devicecheck

EN Ask parents' permission before going online | DE Eltern um Erlaubnis bitten, bevor du online gehst | FR Demande l'autorisation d'un parent avant d'aller en ligne | IT Chiedi il permesso ai tuoi genitori prima di andare online | ES Pídeles permiso a tus papás antes de conectarte a Internet | PT Peça autorização aos pais antes de acederes online | ZH 上网前应先征得父母的同意 | PL Poproś rodziców o zgodę, zanim wejdiesz do Internetu | CS Než půjdeš na internet, požádej rodiče o svolení | SK Skôr než pôjdeš na internet, vypýtaj si povolenie od rodičov | HU Kérj szülői engedélyt, mielőtt online csatlakoznál! | RO Cere permisiunea părinților înainte de a te conecta online | BG Поискайте разрешение от родител, преди да влезете онлайн | LV Pirms došanās tiešsaistē palūdz atļauju vecākiem | ET Enne Interneti kasutamist küsi vanematelt luba | LT Prieš prisijungdami prie interneto, atsklauskite tėvų

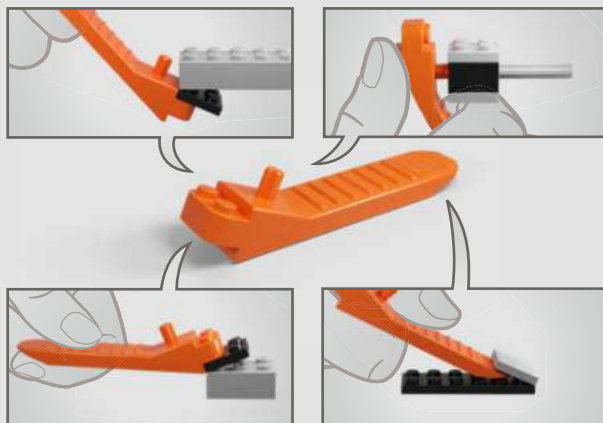

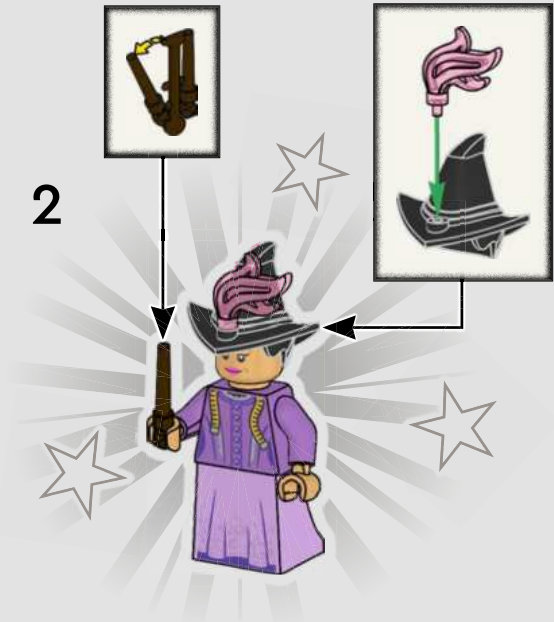
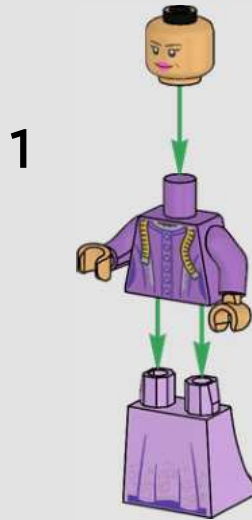

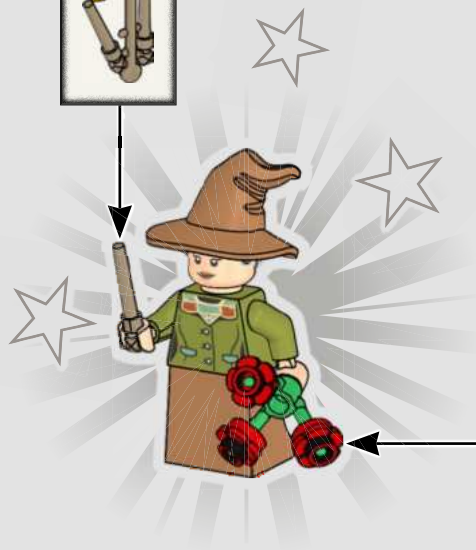
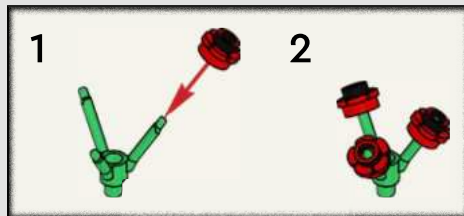

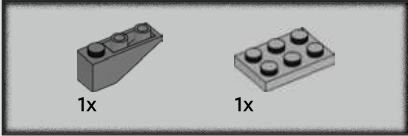

1

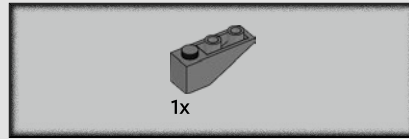
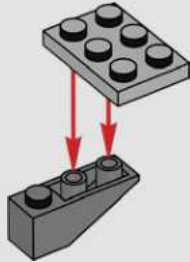

2

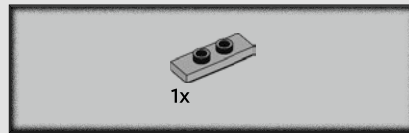
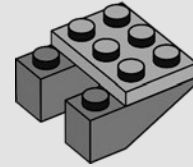

3

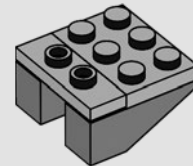



4

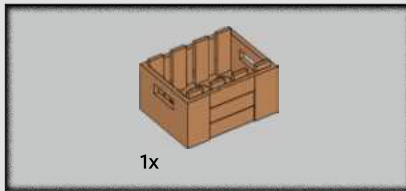
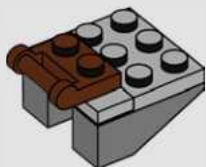

5

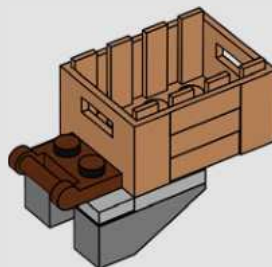



6

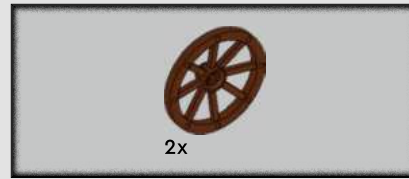
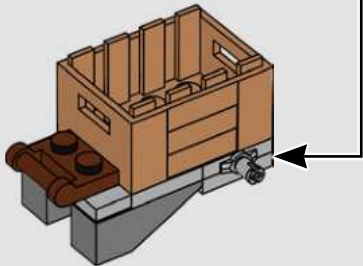
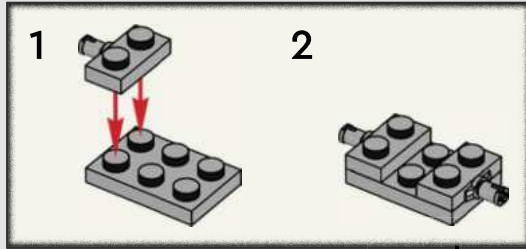

7

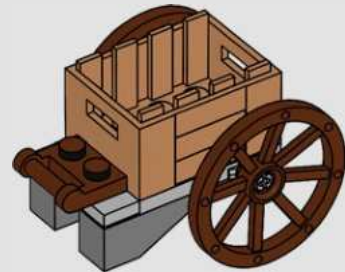

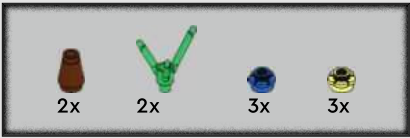

8

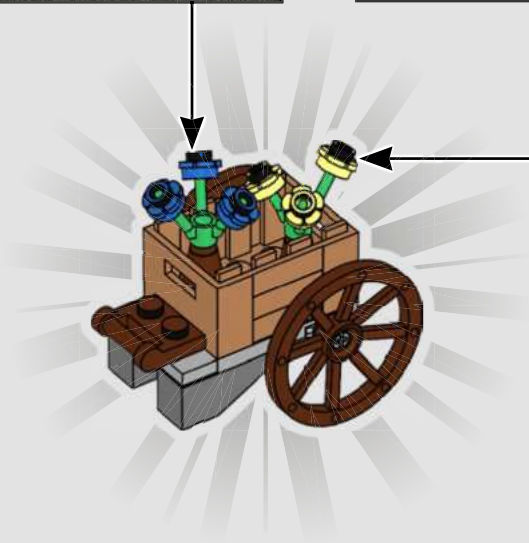
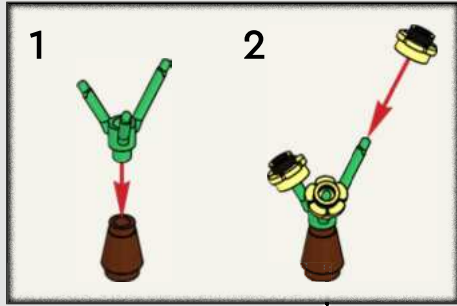
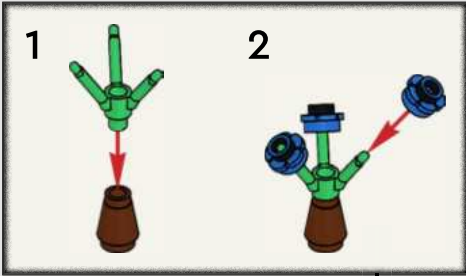

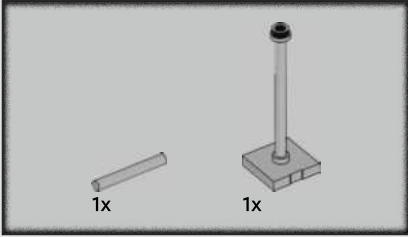

1

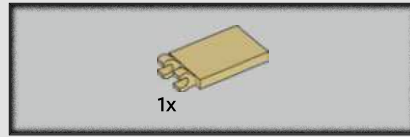

2

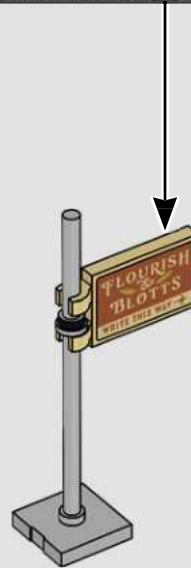
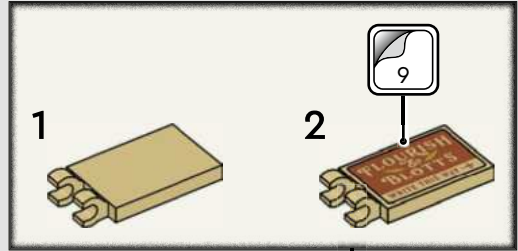

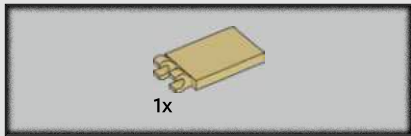

3

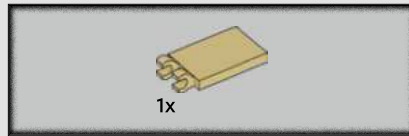
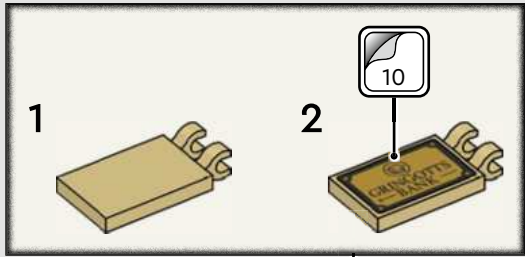

4

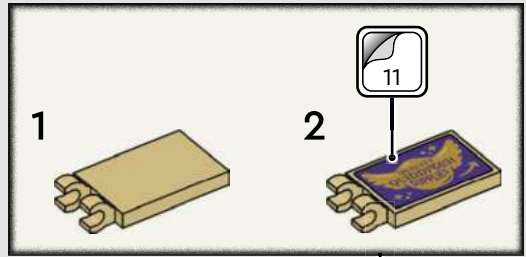

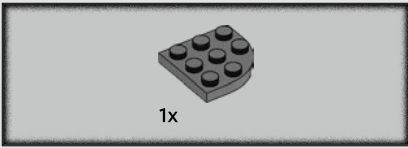

5

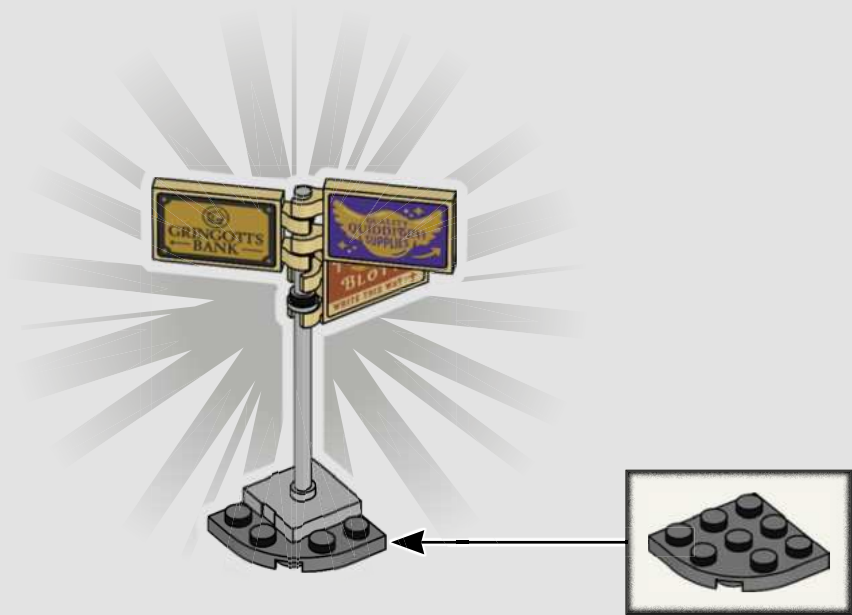

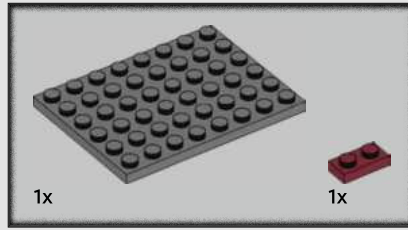

1

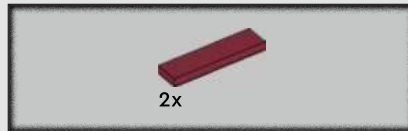
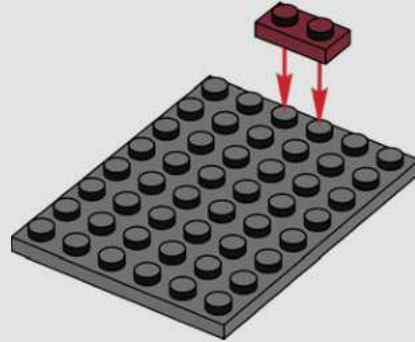

2

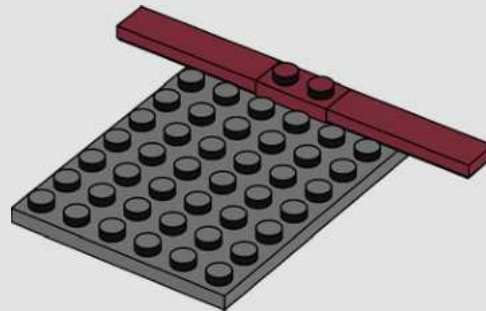

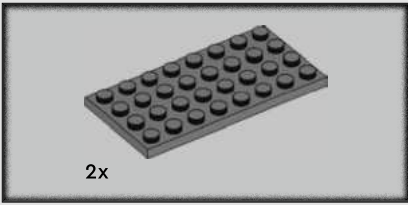

3

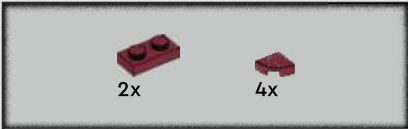
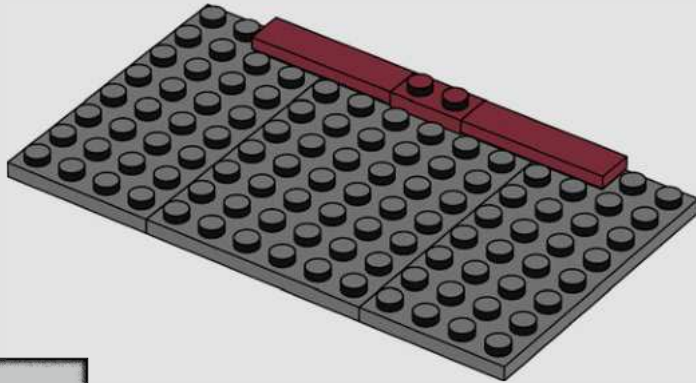

4

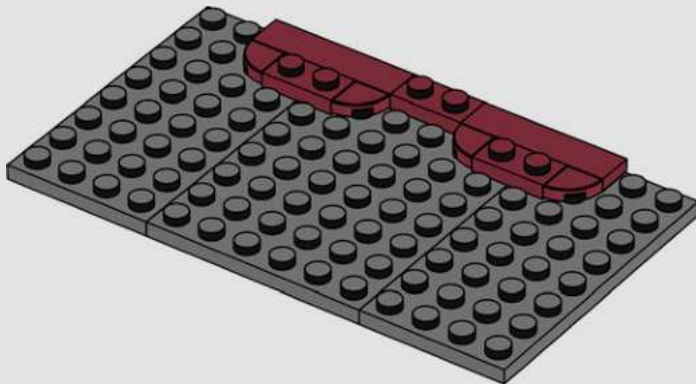

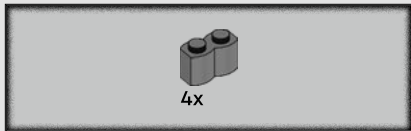

5

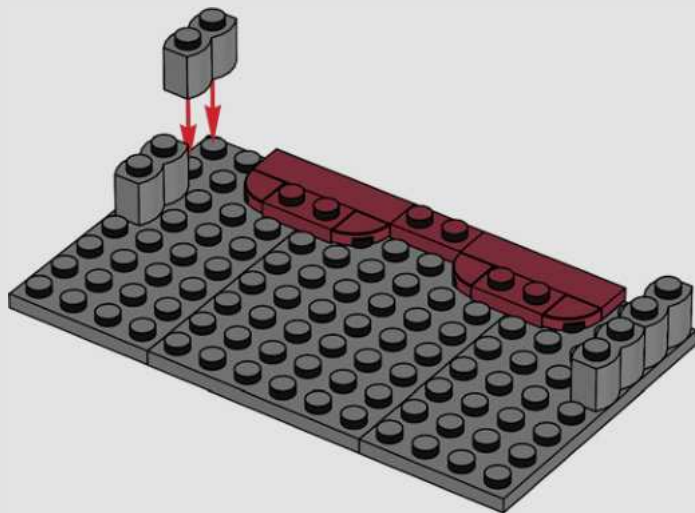

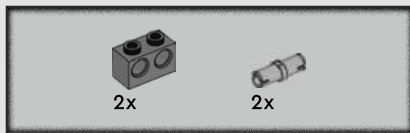

6

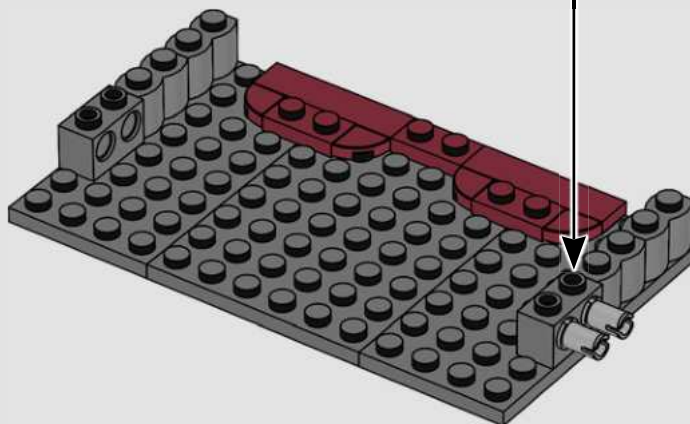
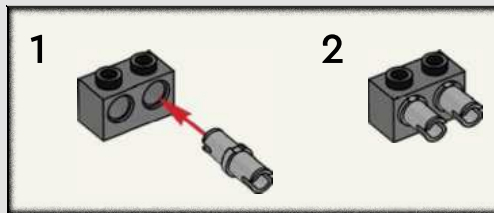

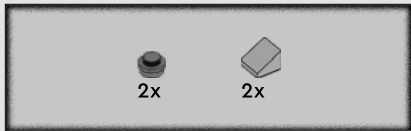

7

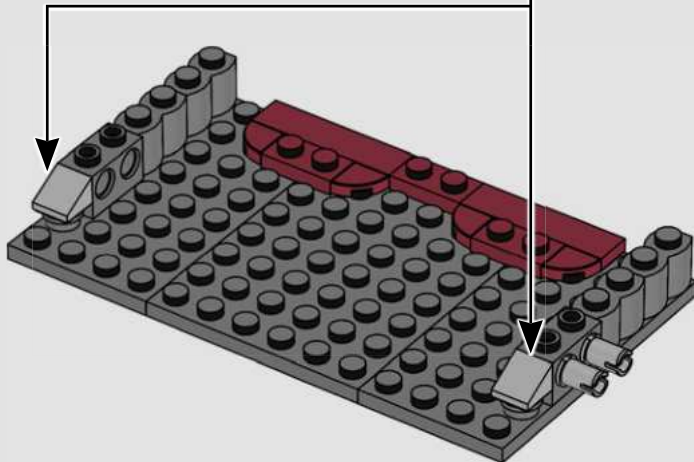
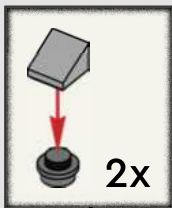

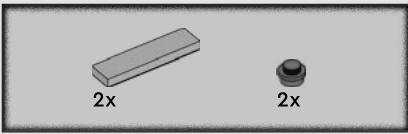

8

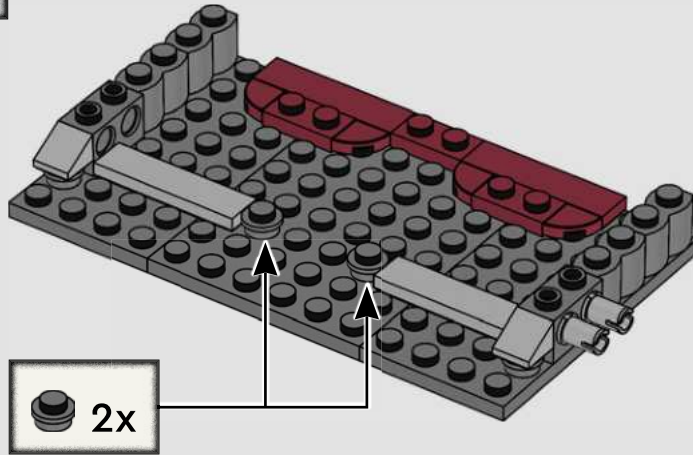

9

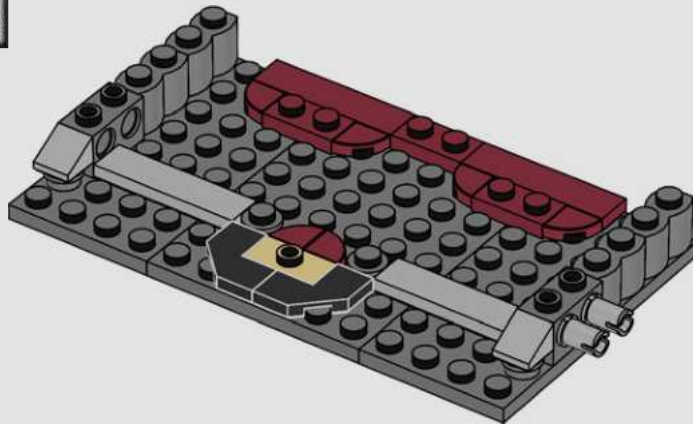

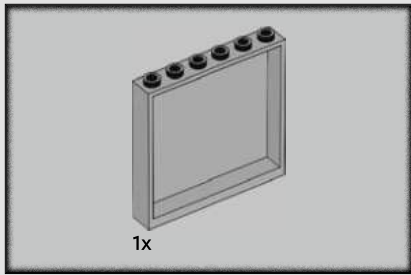

10

1

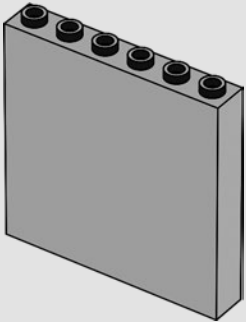

2

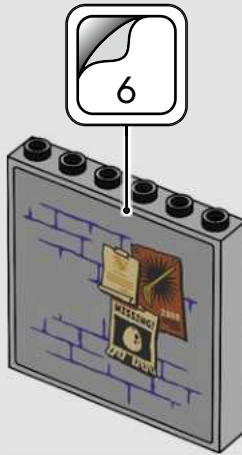

3

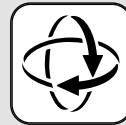

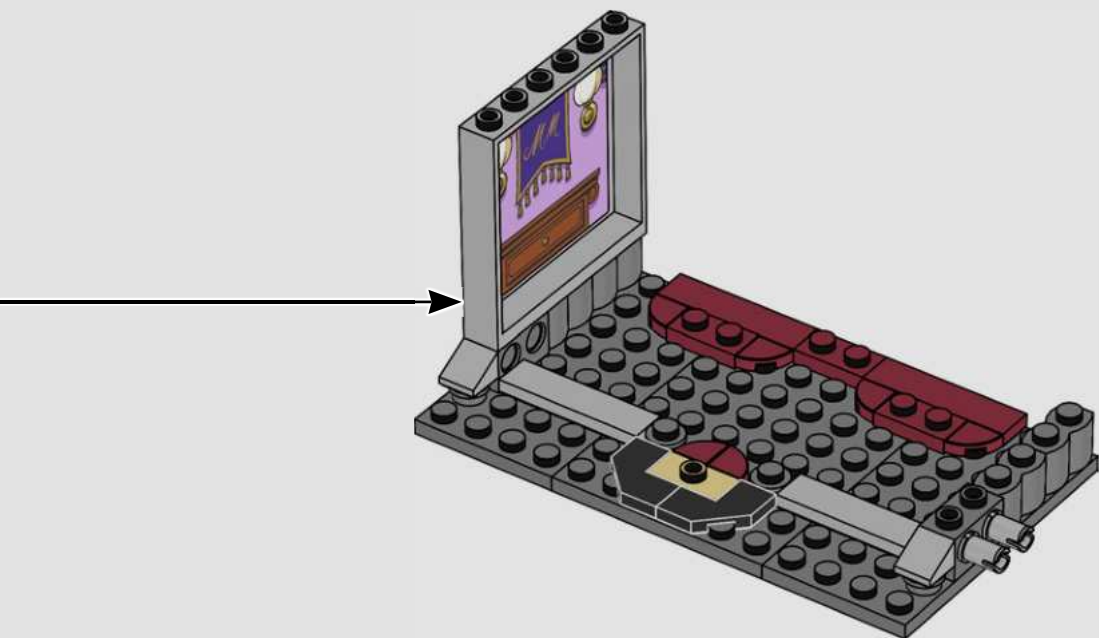

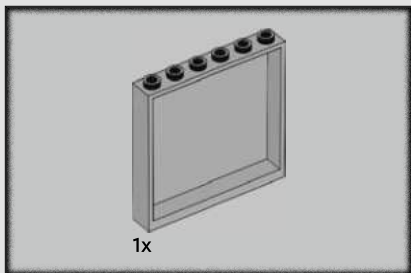

11

1

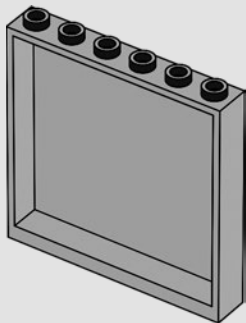

2



3

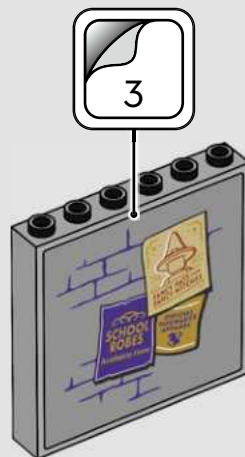

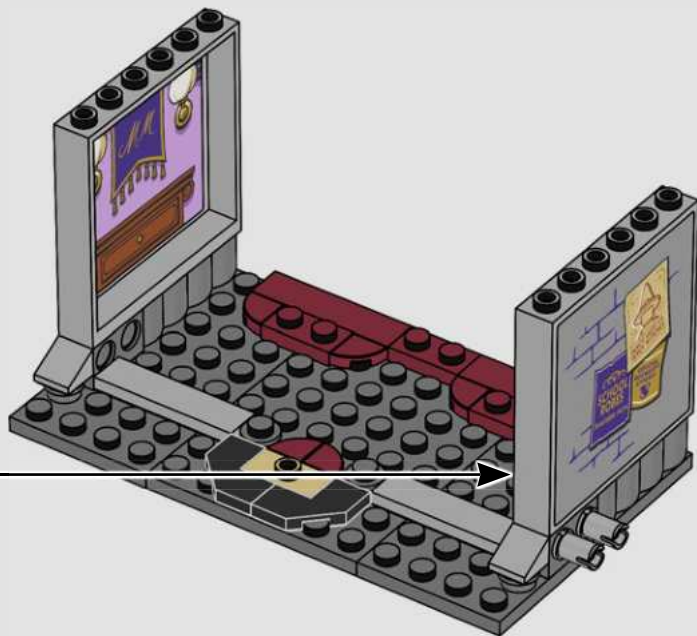

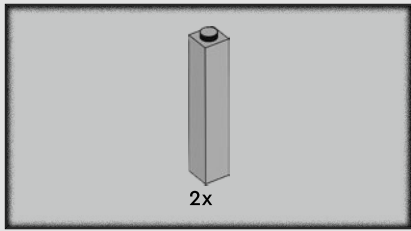

12



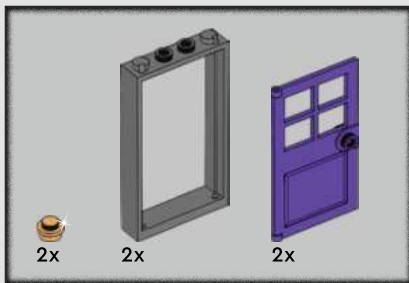

13

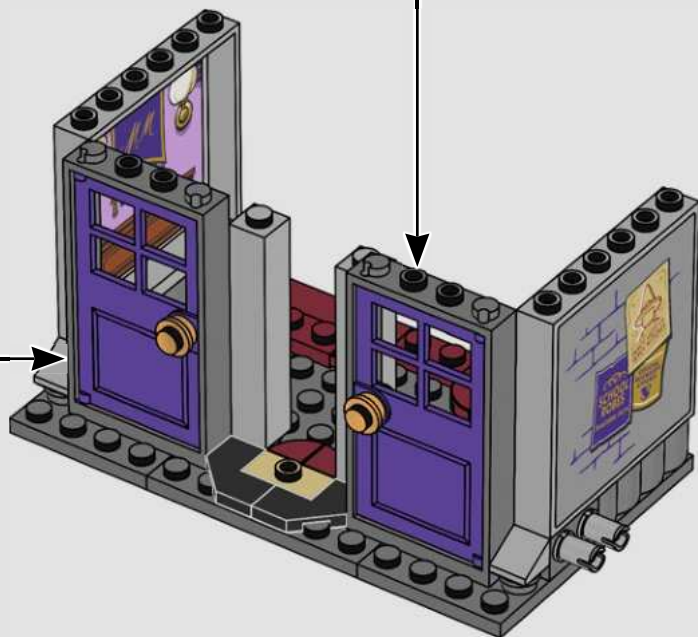
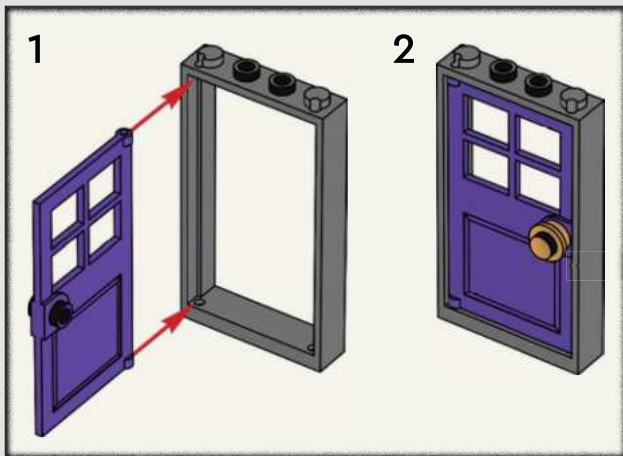
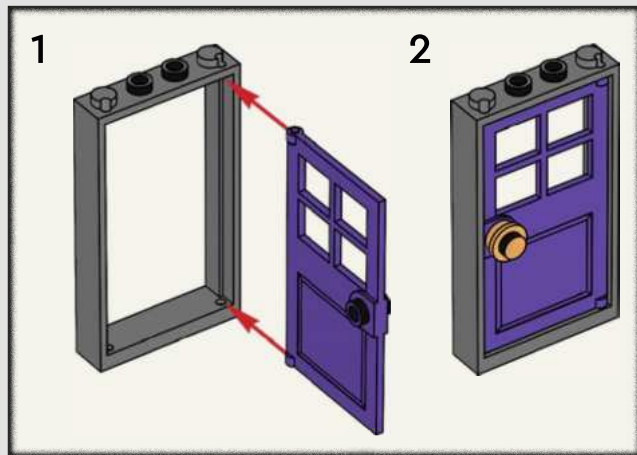



14

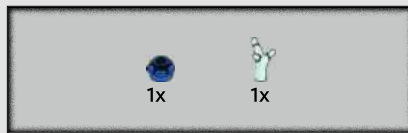
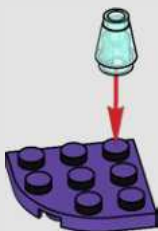

15

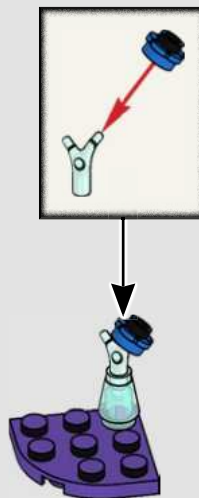

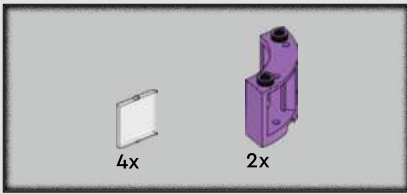

16

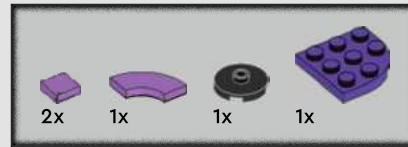
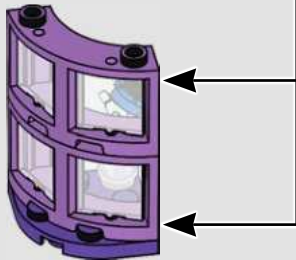
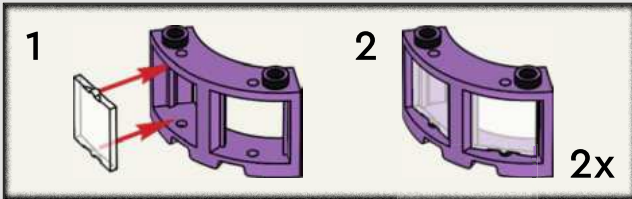

17

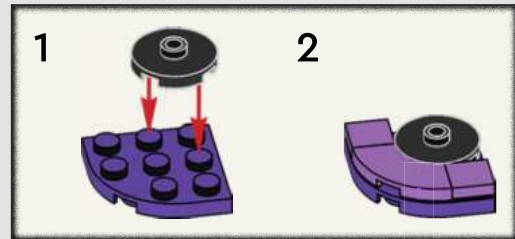

18

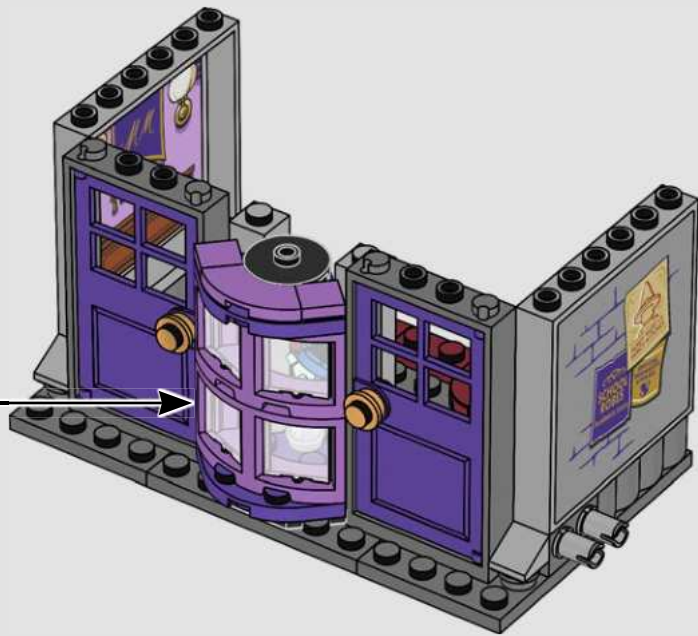

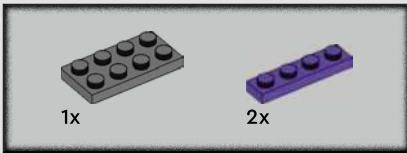

19

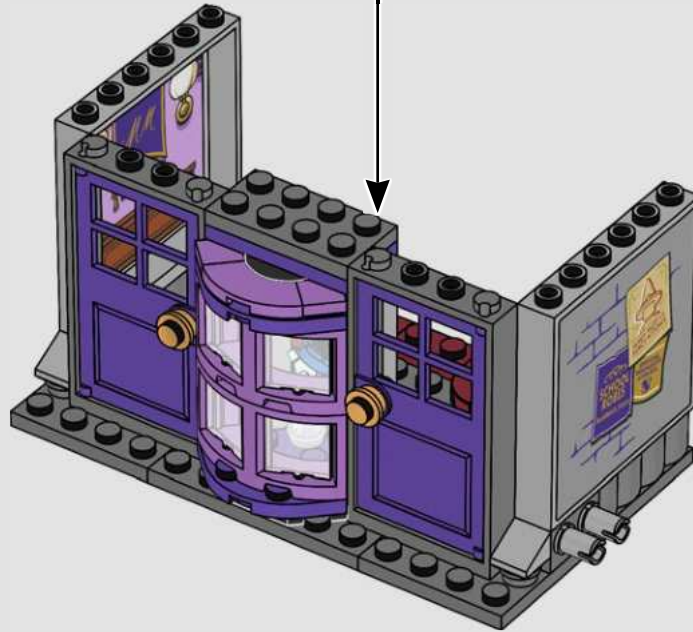
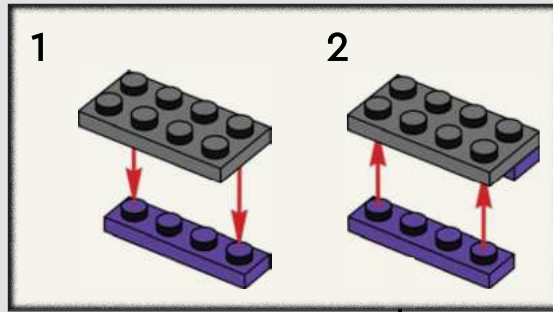

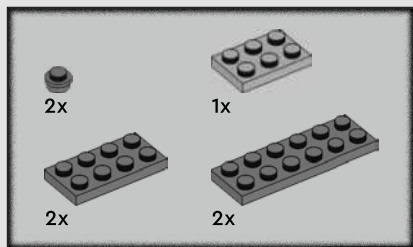

20

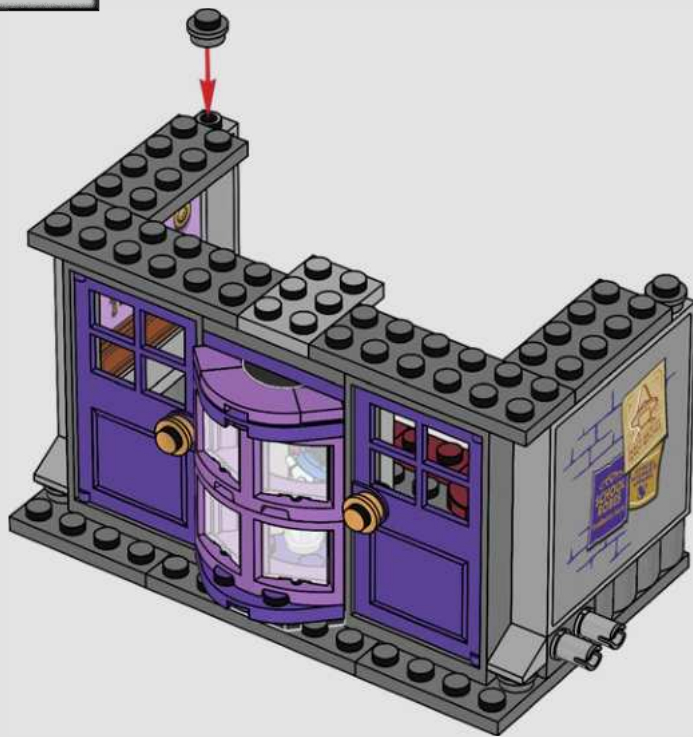



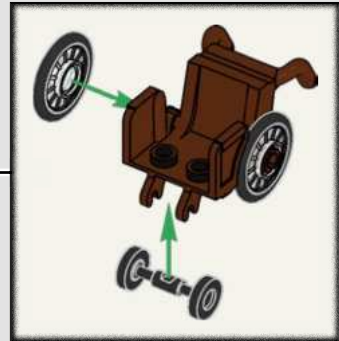
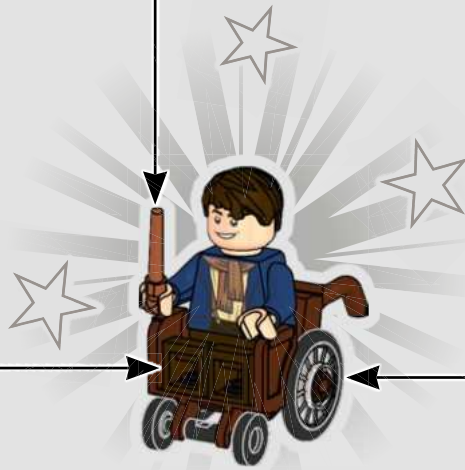
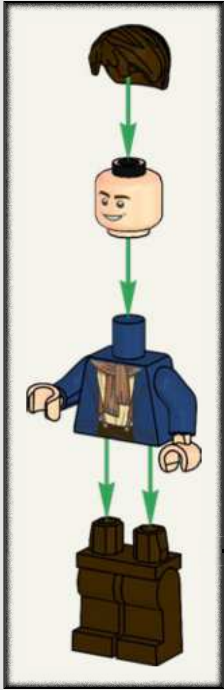

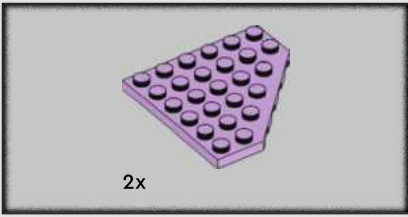

21



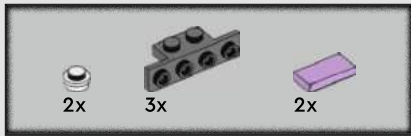

22

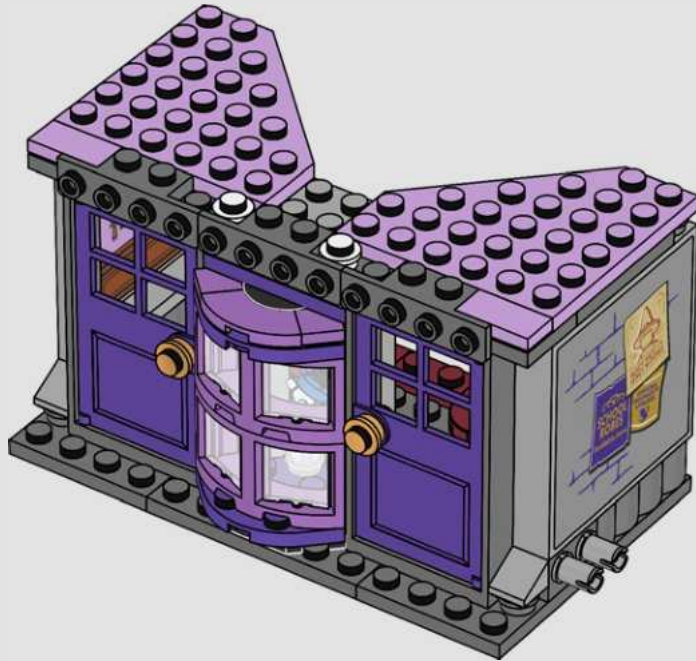

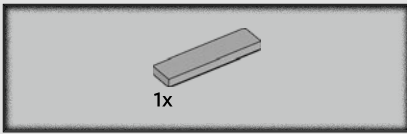

23



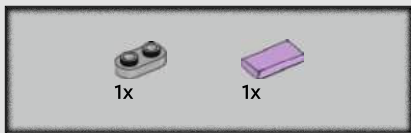

24

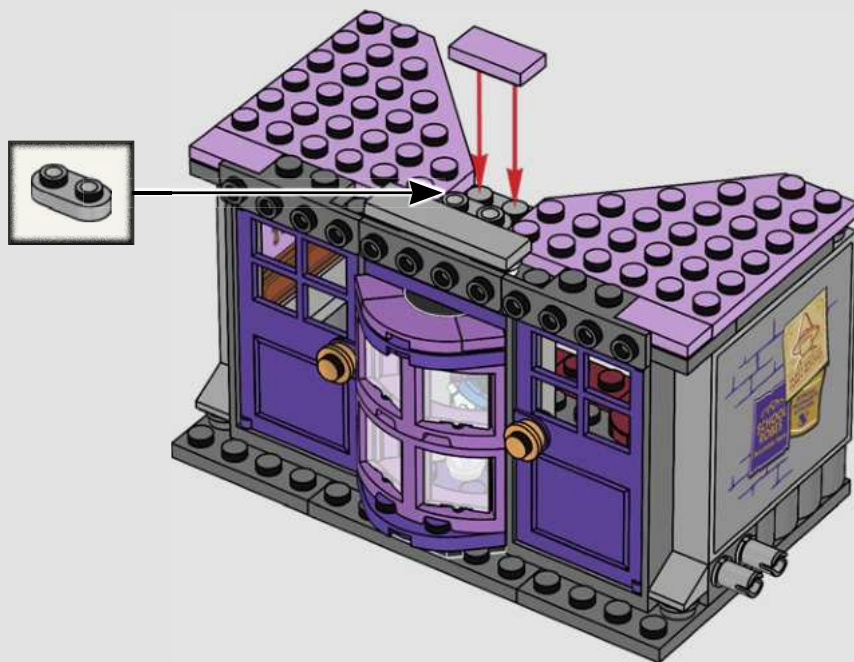

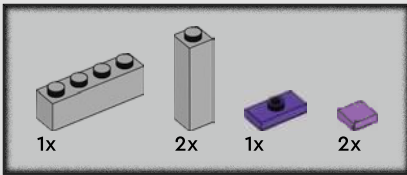

25

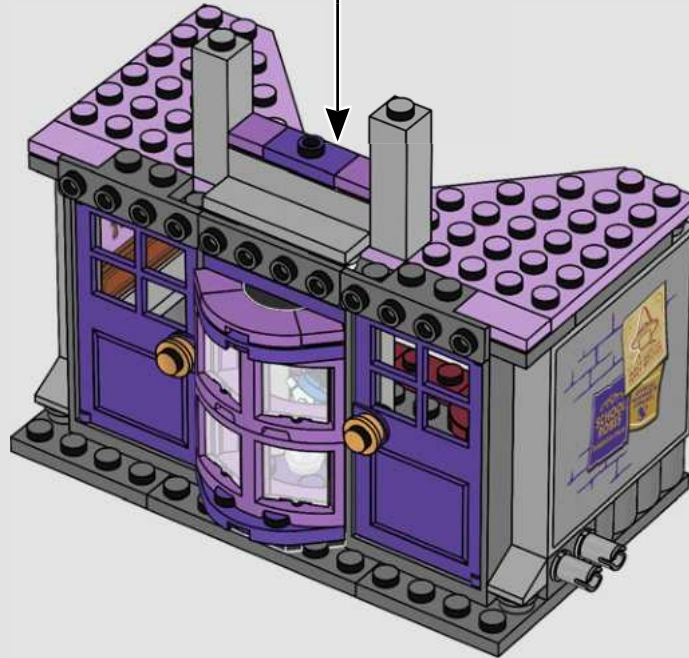
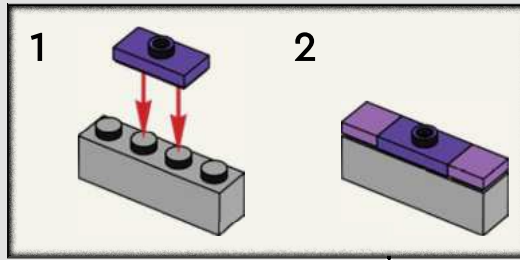

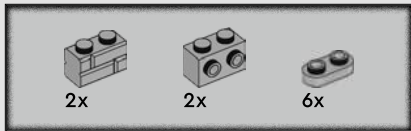

26

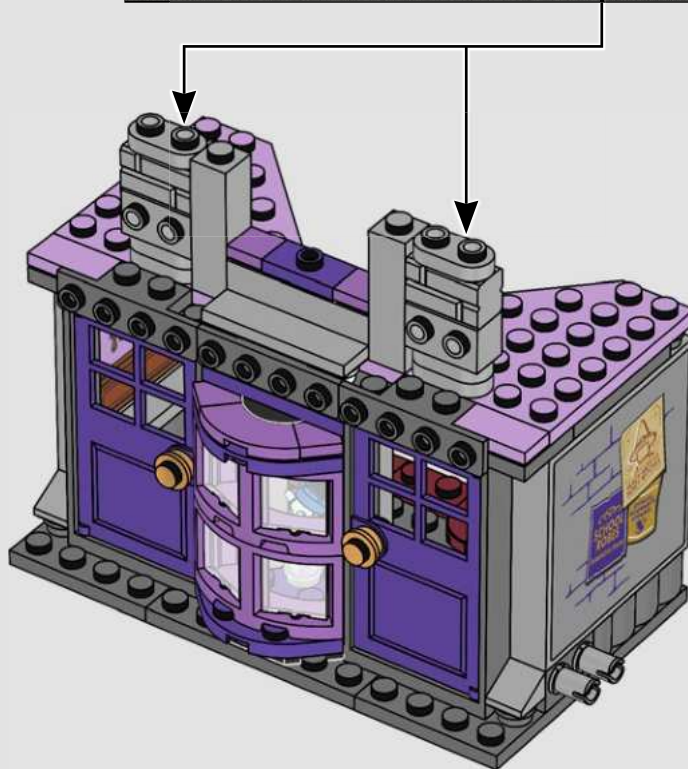
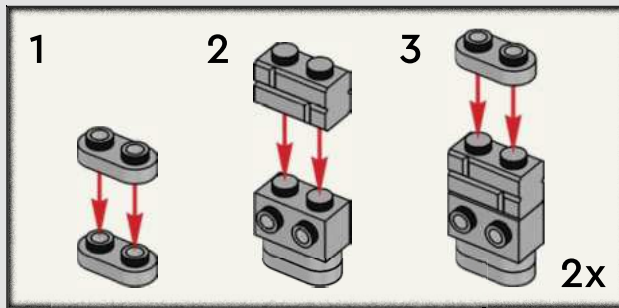

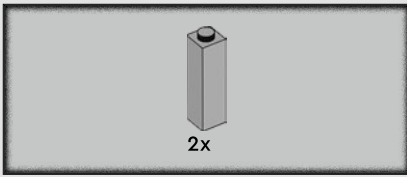

27

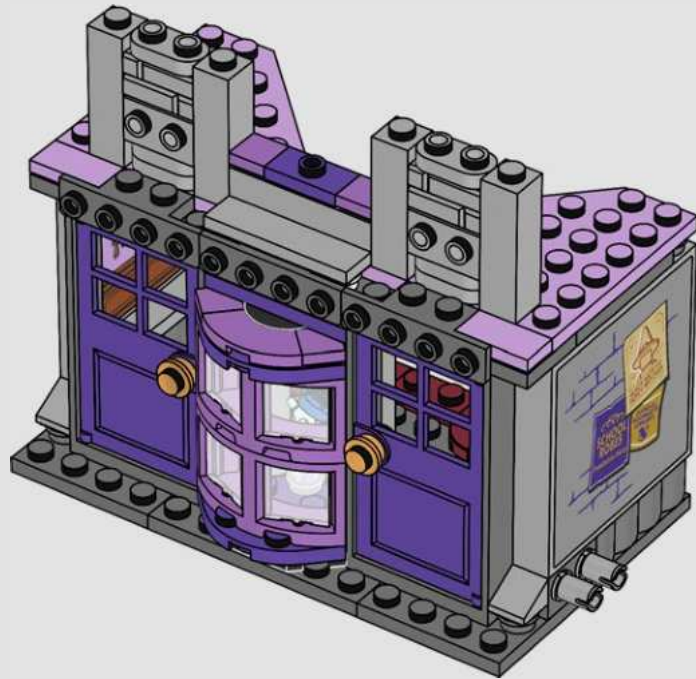

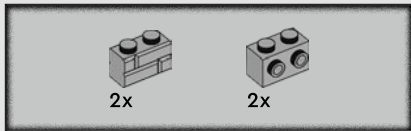

28

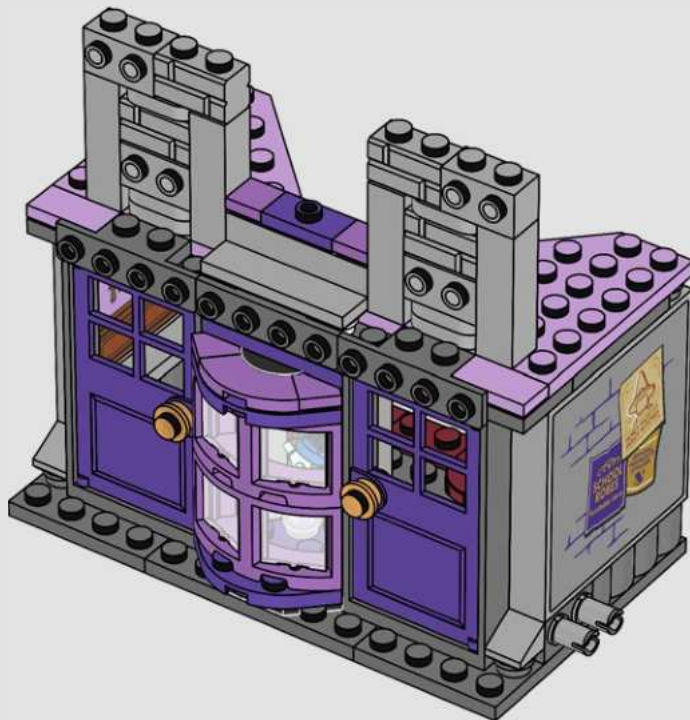

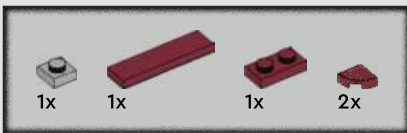

29



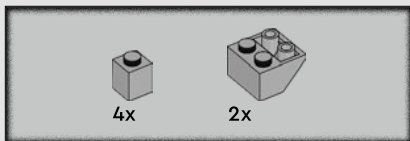

30



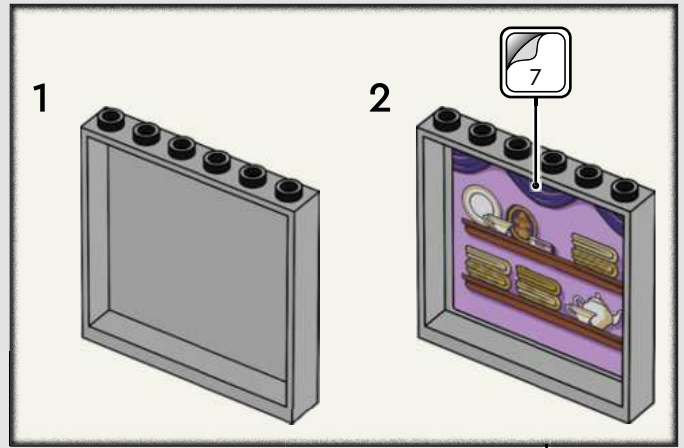
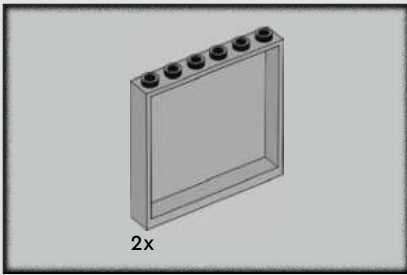

31





32



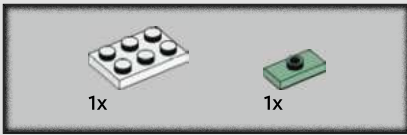

33

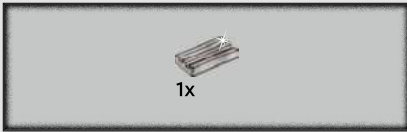

34



35

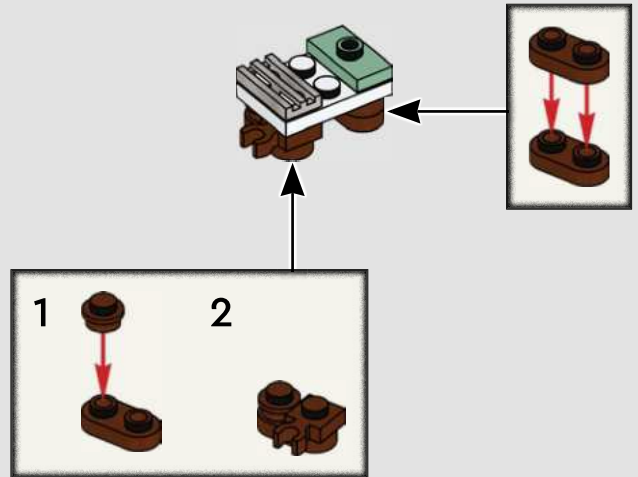

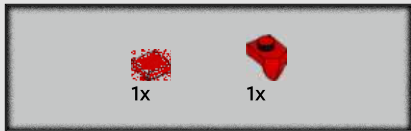

36

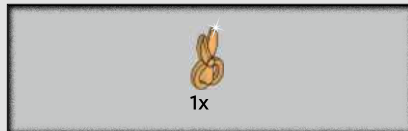

37



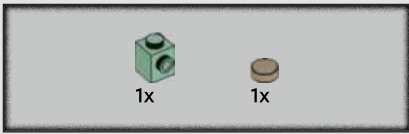

38

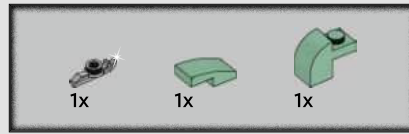
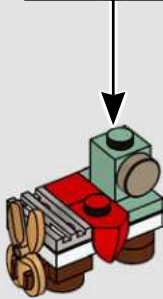
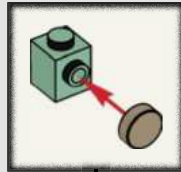

39

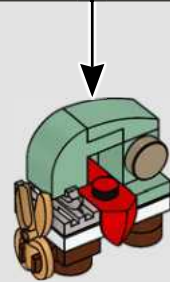
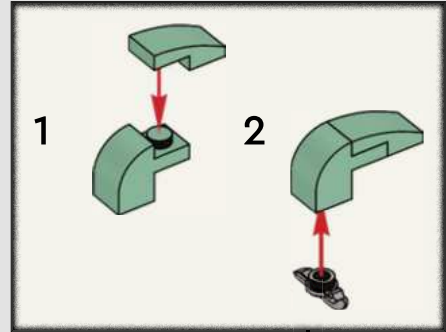

40

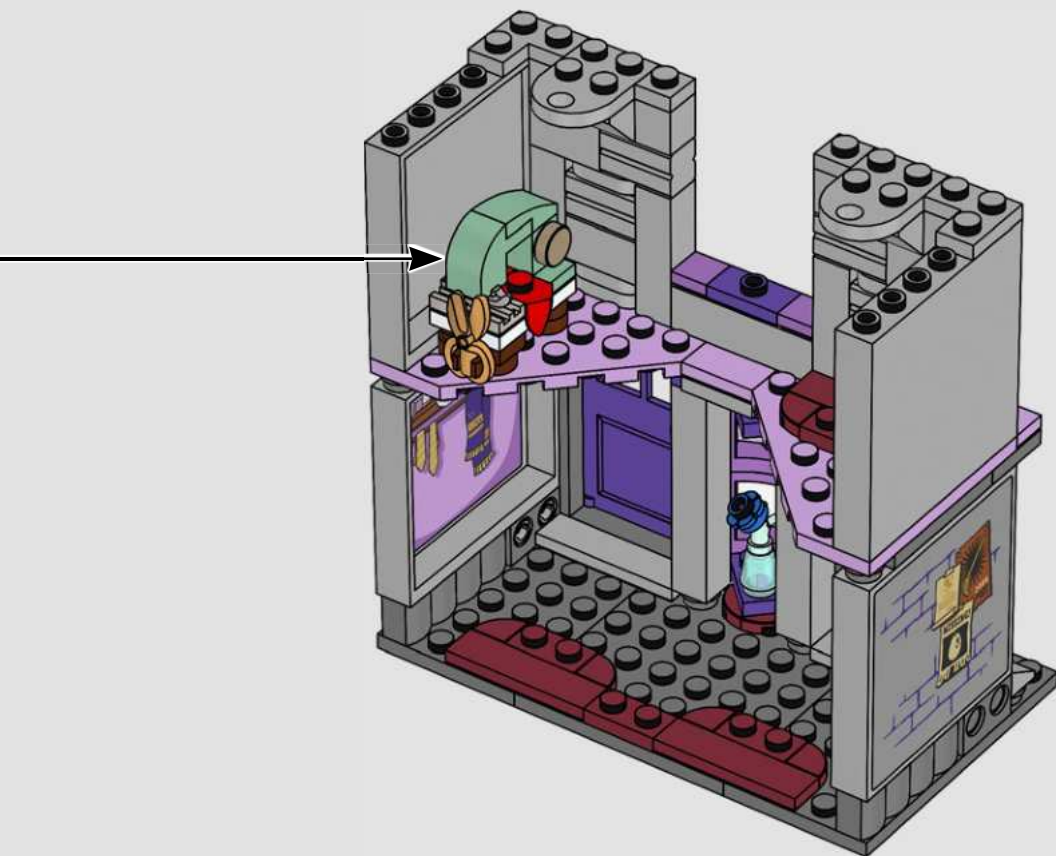

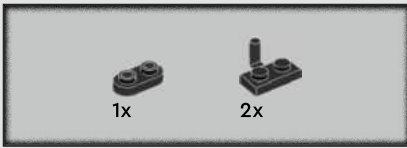

41



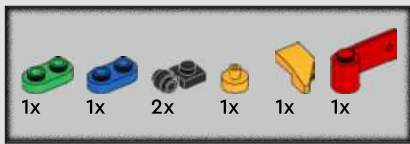

42

1



2

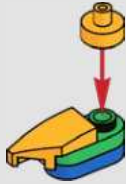

3

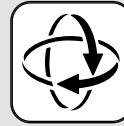

4

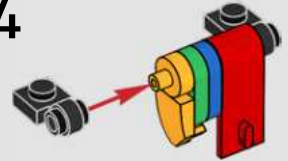

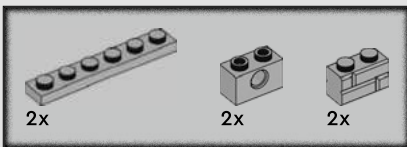

43

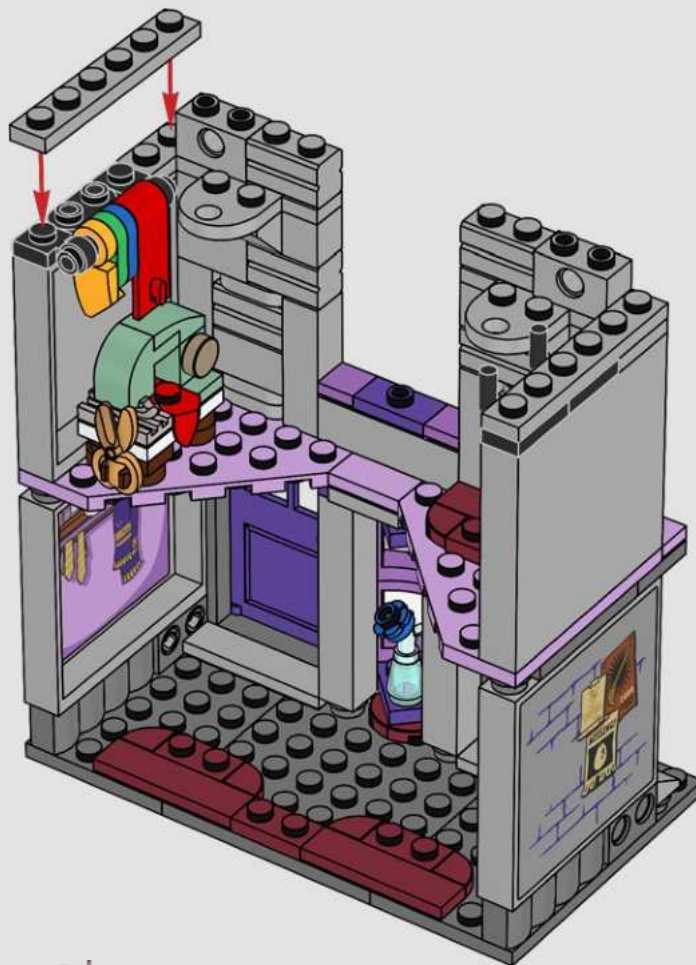

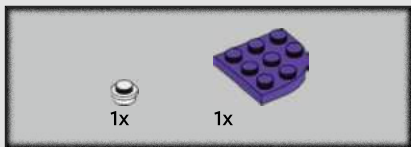

44



45

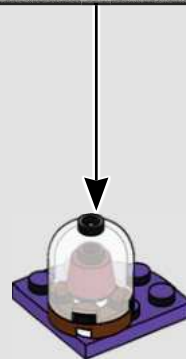

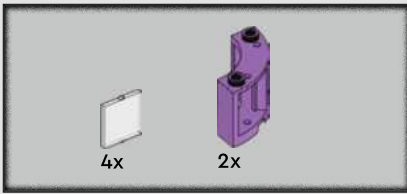

46

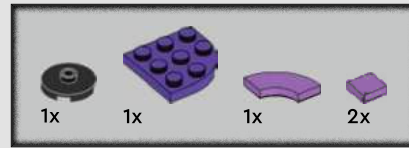
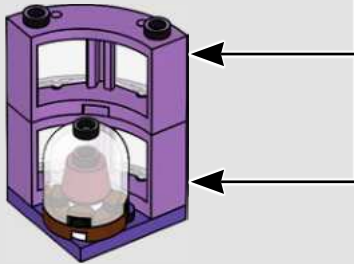
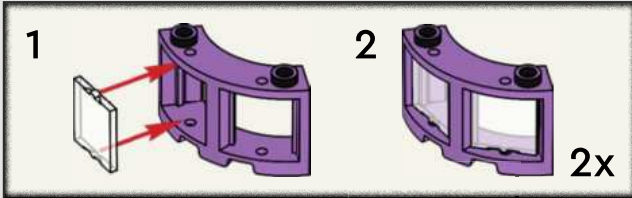

47

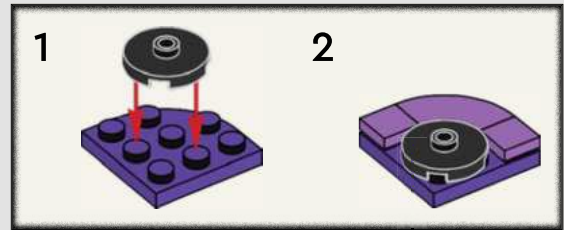

48



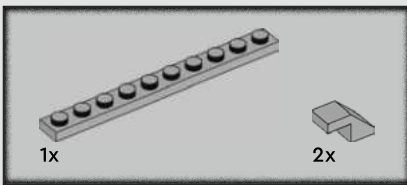

49



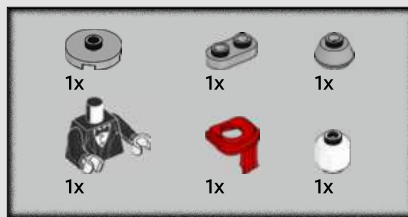

50

1



2

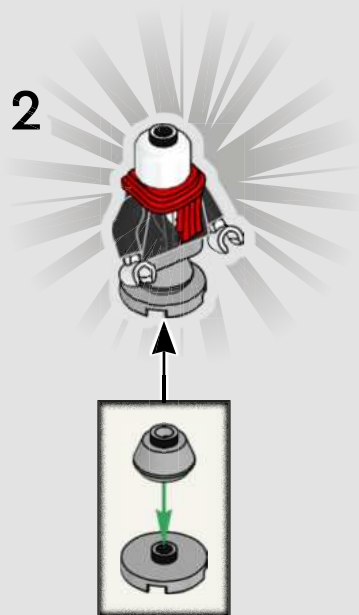

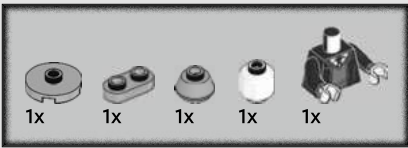

51

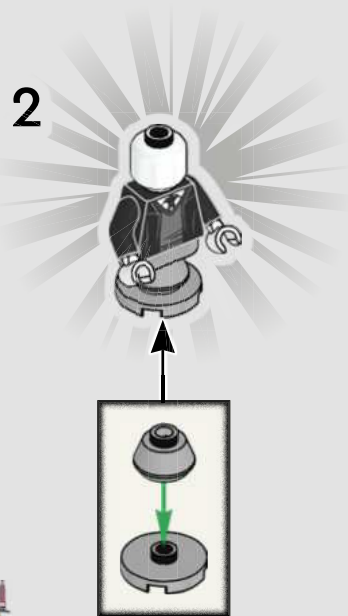
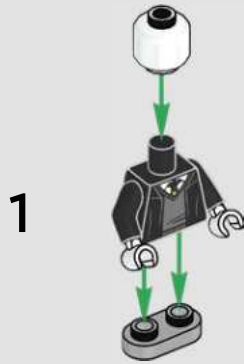



52

1

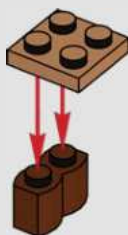

2



3



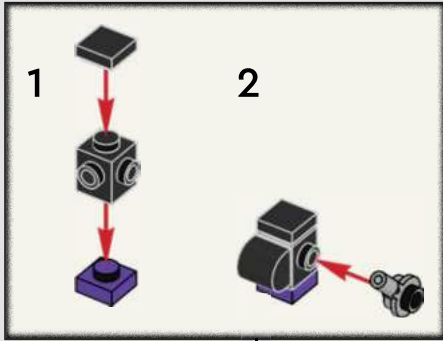

4



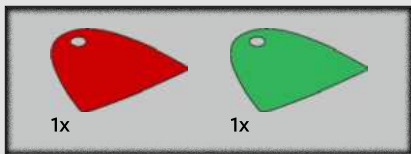

53

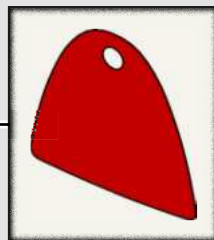
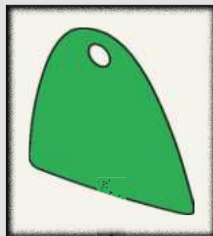



54

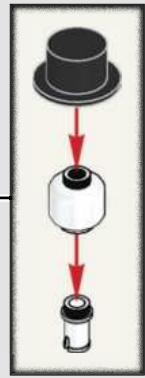

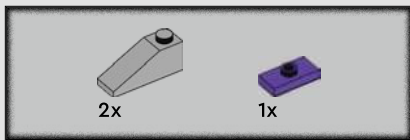

55





56





57

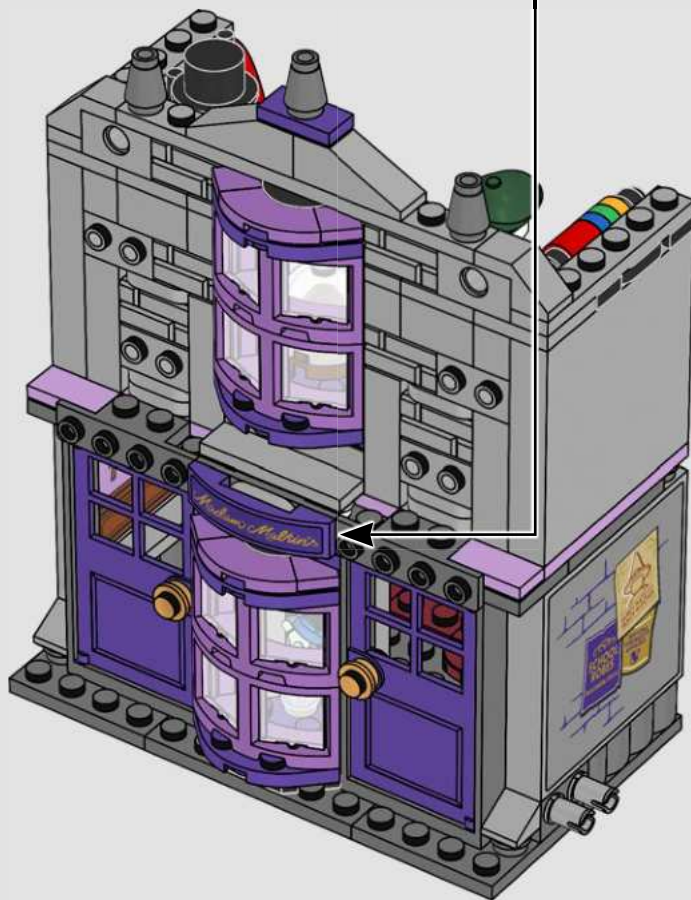
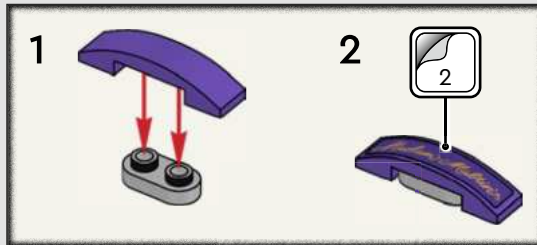

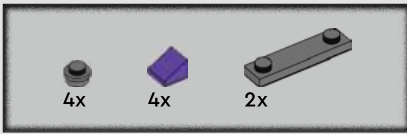

58

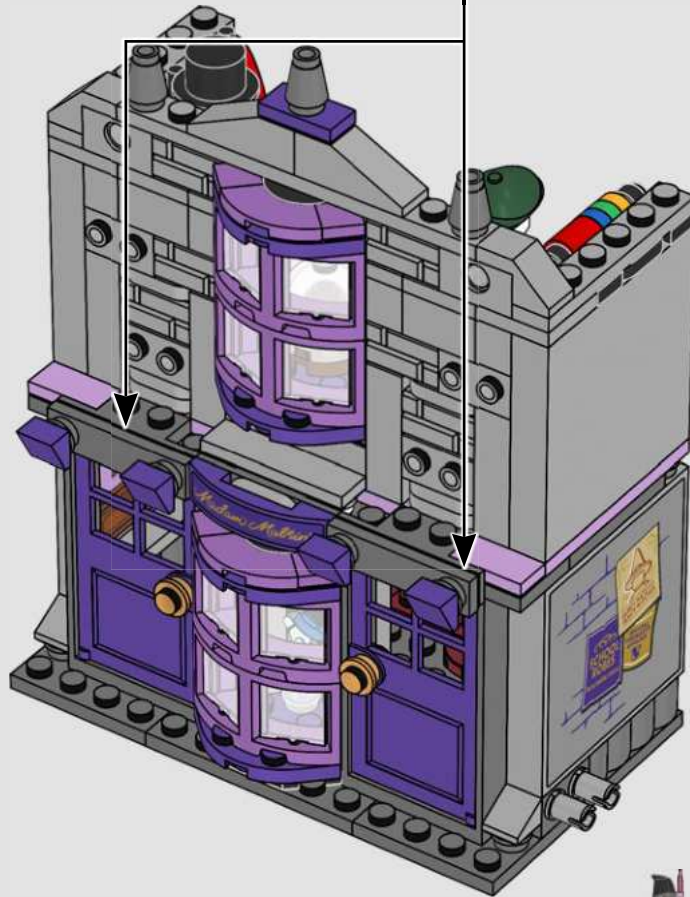
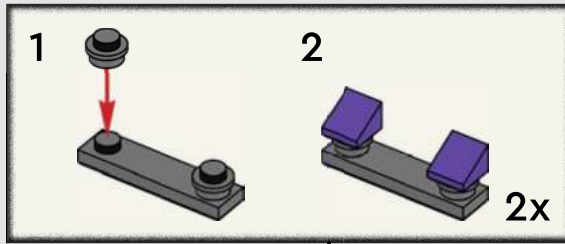

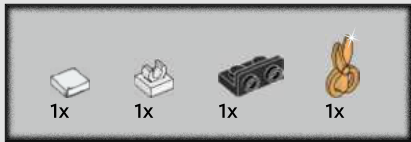

59

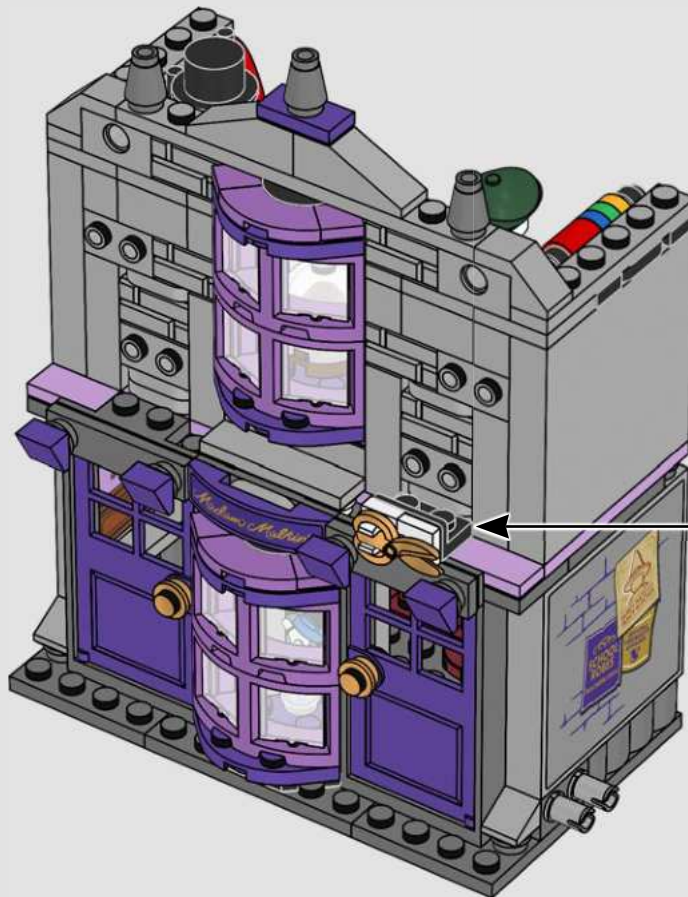
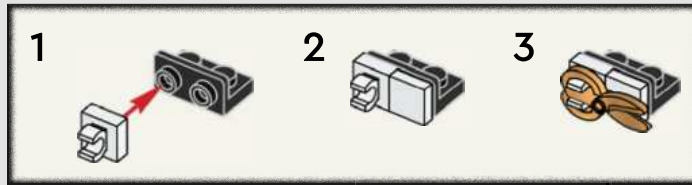

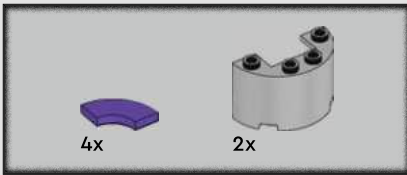

60

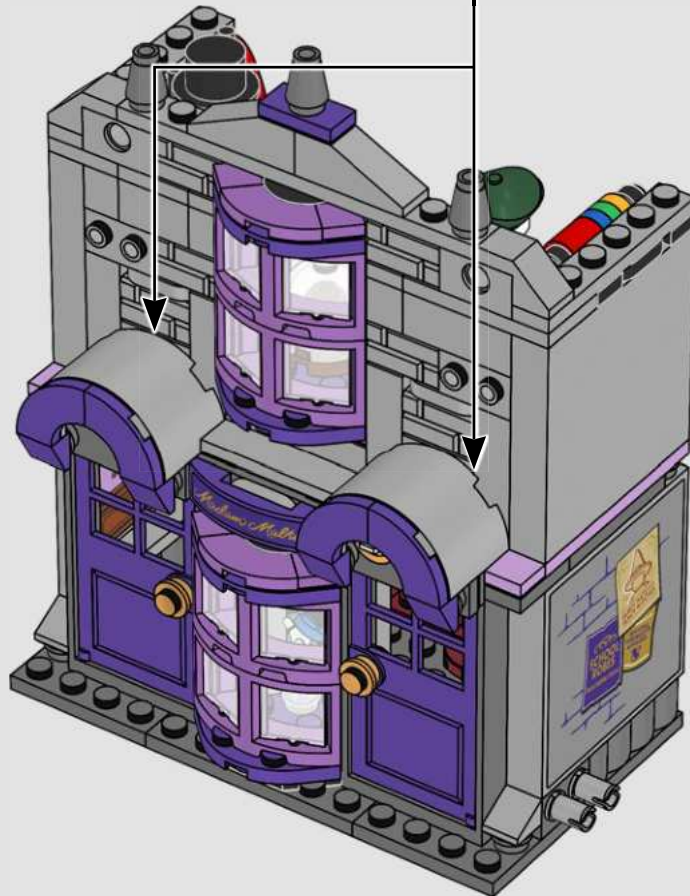
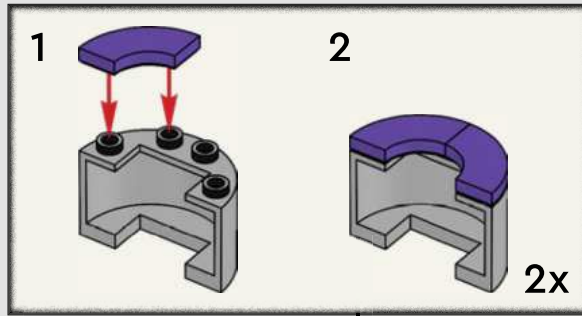

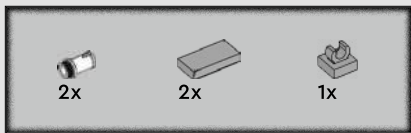

61

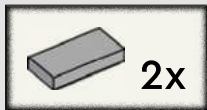
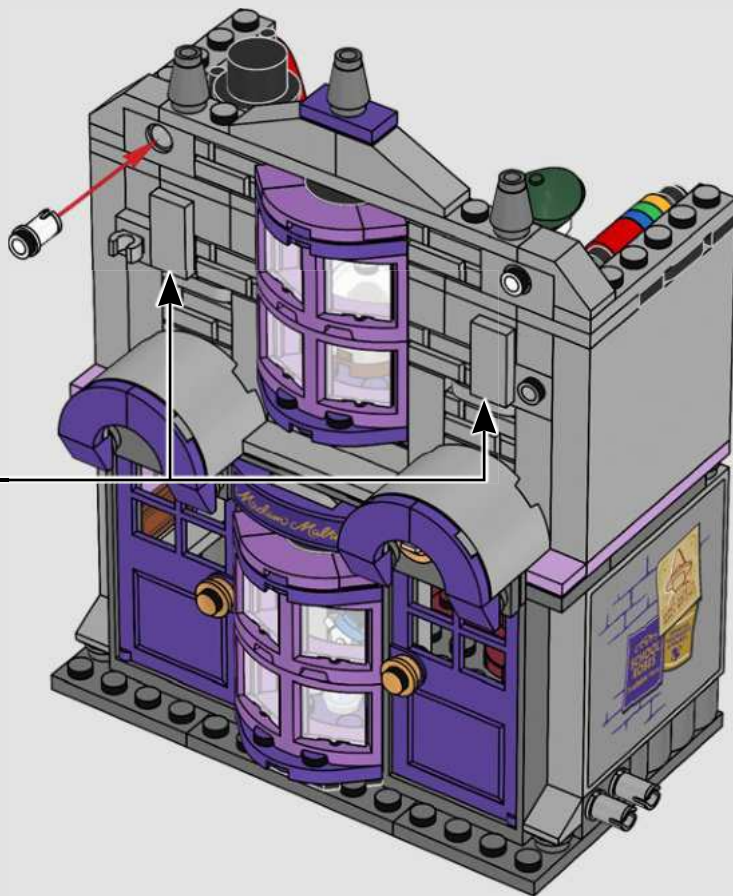

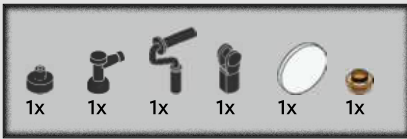

62

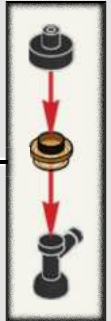
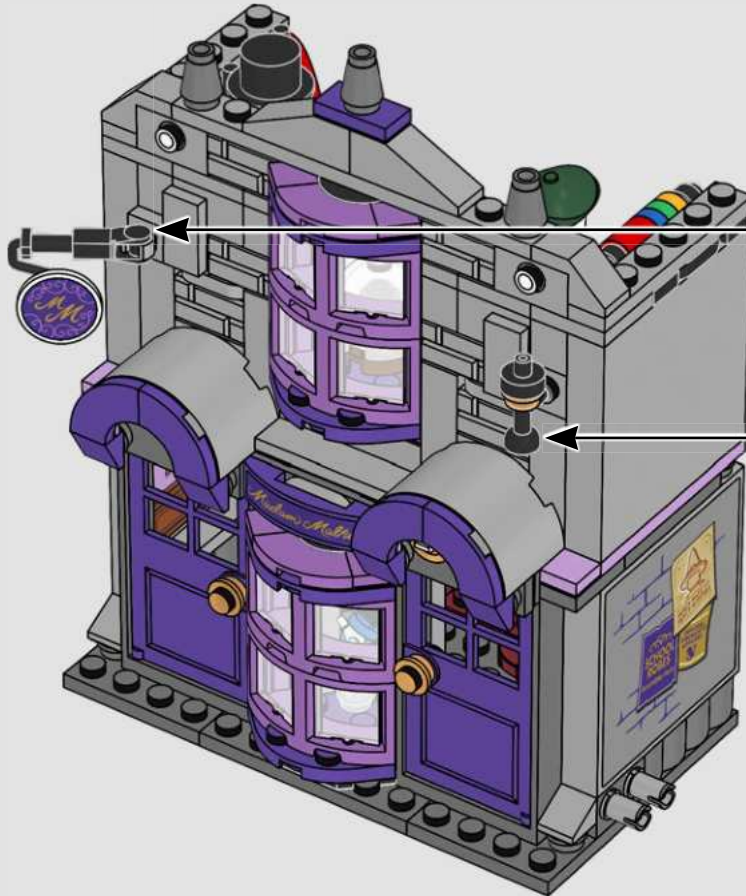
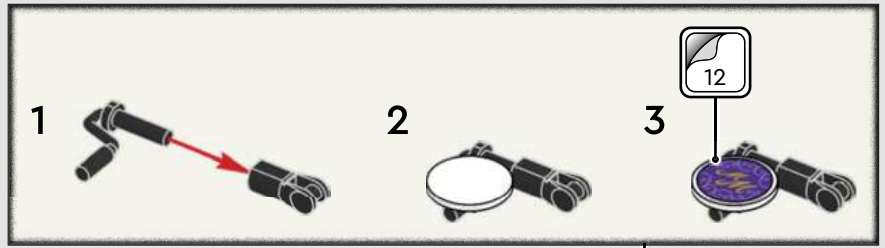

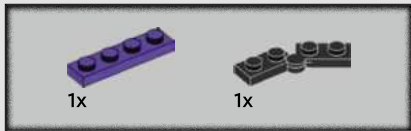

63

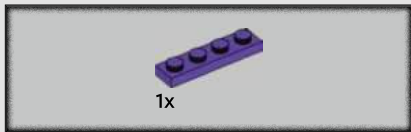
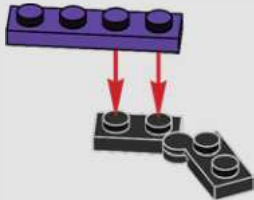

64

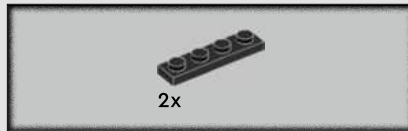

65

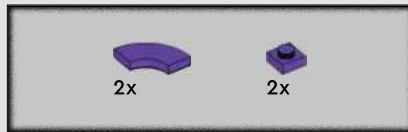
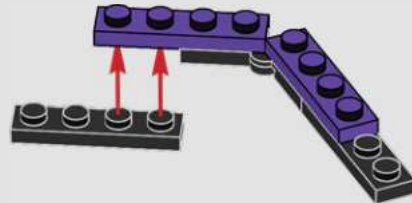

66



67

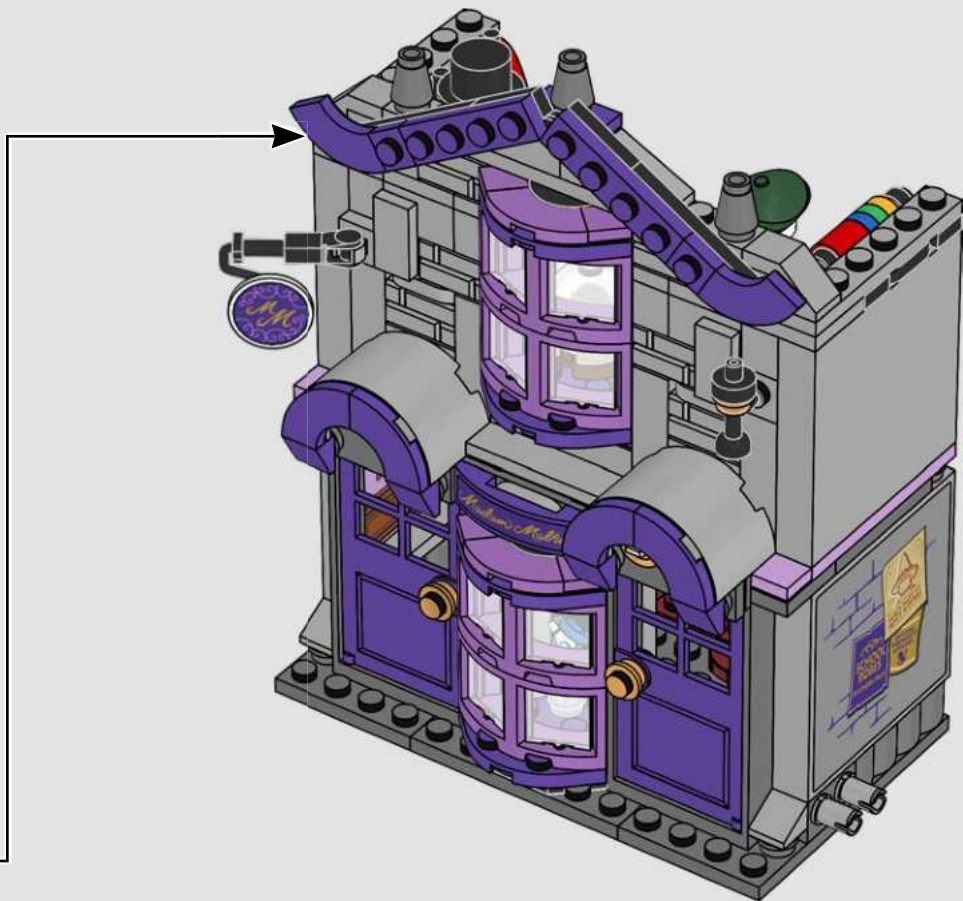







Harry Potter



76435



Each set sold separately and available for different periods of time /
Jedes Set ist separat und in unterschiedlichen Zeiträumen erhältlich.
/ Chaque set est vendu séparément et sera disponible à des périodes
différentes. / Ogni set è venduto separatamente ed è disponibile per
periodi di tempo diversi. / Cada set se vende por separado y está
disponible durante un cierto período de tiempo. / Os sets são vendidos
separadamente e estão disponíveis por diferentes períodos de tempo.
/ 每款套装于不同时间段单独出售。 / Zestawy są sprzedawane
osobno i są dostępne w różnym czasie / Každá stavebnice se prodává
samostatně a je k dispozici v různých časových obdobích / Každá
stavebnice sa predáva samostatne a je k dispozícií v rôznych časových
obdobiach / Minden egyes készlet külön-külön és más-más időszokban
kapható. / Seturile se vând separat și sunt disponibile pentru perioade
diferite de timp / Всеки комплект се продава отделно и е наличен
за различен период от време. / Katrs komplekts tiek pārdots
atsevišķi, un to pieejamības periodi atšķiras. / Kõik komplektid on
müügil eraldi ja saadaval erinevates ajavahemikes. / Kiekvienas rinkinys
parduodamas atskirai ir tik ribotą laiką

76426



Build the most detailed HOGWARTS™ CASTLE



Baue das detailreiche Schloss Hogwarts™ / Construisez le château de Poudlard le plus détaillé / Costruisci il Castello di Hogwarts™ più dettagliato di sempre / Construye el Castillo de Hogwarts™ más detallado / Construa o mais detalhado Castelo de Hogwarts™ / 拼搭精美的霍格沃茨™城堡 / Zbuduj najbardziej szczegółowy zamek Hogwarts™ / Postavte si ten najdetailnejší Bradavický hrad / Postavte si najdetailnejší Rokfortský hrad / Építsd meg a legrészletgazdagabb Roxfort™ kastélyt! / Construieste cel mai detaliat Castel Hogwarts™ / Постройте наиболее детализованную версию на замька Хогвортс / Узбувте висдеталізовану Цуккарпас пиль / Pane kokku kõige üksikasjalikum Sigatüüka™ loss / Sukonstruokite neparastai detalią Hogwartso pilį

YOU COULD **WIN**

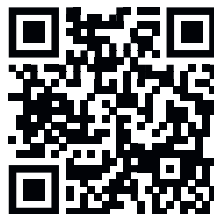

Scan this QR code or go to **LEGO.COM/PRODUCTFEEDBACK** and give us your short feedback about this LEGO® set for a chance to win a cool LEGO prize.

Terms and Conditions apply*

EN: YOU COULD WIN. Terms and Conditions apply* **DE: Du könntest GEWINNEN.** Es gelten die Teilnahmebedingungen* **FR: Tu pourrais GAGNER.** Des conditions s'appliquent* **IT: Potresti VINCERE tu.** Termini e condizioni sono applicabili* **ES: Puedes GANAR.** Aplican términos y condiciones* **PT: Poderá GANHAR.** Aplicam-se termos e condições* **ZH: 轻松获奖. 条款和条件适用*** **PL: Szansa na WYGRANĄ.** Obowiązują warunki korzystania* **CS: Máte šanci VYHRÁT.** Platí všeobecné smluvní podmínky* **SK: Máte šancu VYHRAŤ.** Platia všeobecné zmluvné podmienky* **HU: TE IS NYERHETSZ.** Felhasználási feltételek érvényesek* **RO: Ai putea CÂȘTIGA.** Se aplică termeni și condiții* **BG: Можете да СПЕЧЕЛИТЕ.** Има определени правила и условия* **LV: Tu vari LAIMĒT.** Ir spēkā noteikumi un nosacījumi.* **ET: Sul on võimalus VÕITA.** Kehtivad tingimused* **LT: Jūs galite LAIMĖTI.** Taikomos sąlygos*

*[LEGO.com/productfeedback-terms](https://www.lego.com/productfeedback-terms)

LEGO and the LEGO logo are trademarks of the LEGO Group. ©2024 The LEGO Group.

WIZARDING WORLD and all related trademarks, characters, names, and indicia are © & ™ Warner Bros. Entertainment Inc. Publishing Rights © JKR. (s24)