



Disney

43246



Q LEGO® Builder

1

2

3



Get excited about our new packaging!

We're switching from plastic to paper-based packaging. That's why you might find a mix of paper and plastic in our boxes!

Nos nouveaux emballages vous emballeront !

Nous passons des emballages en plastique aux emballages à base de papier. C'est pourquoi vous pourriez trouver un mélange de papier et de plastique dans nos boîtes !

¡Te presentamos nuestros nuevos empaques!

Estamos sustituyendo las bolsas de plástico por bolsas con base de papel. ¡Por eso, puedes encontrar una mezcla de papel y de plástico en nuestras cajas!

[LEGO.com/sustainable-packaging](https://www.lego.com/sustainable-packaging)



Q LEGO® Builder

BUILDER



Apple and the Apple logo are trademarks of Apple Inc., registered in the U.S. and other countries and regions. App Store is a service mark of Apple Inc. Google Play and the Google Play logo are trademarks of Google LLC. Tencent and the Tencent logo are trademarks of Tencent Inc.

Q LEGO.com/devicecheck

EN Ask parents' permission before going online | DE Eltern um Erlaubnis bitten, bevor du online gehst | FR Demande l'autorisation d'un parent avant d'aller en ligne | IT Chiedi il permesso ai tuoi genitori prima di andare online | ES Pídeles permiso a tus papás antes de conectarte a Internet | PT Pede autorização aos pais antes de acederes online | ZH 上网前应先征得父母的同意 | PL Poproś rodziców o zgodę, zanim wejdziesz do Internetu | CS Než půjdeš na internet, požádej rodiče o svolení | SK Skôr než pôjdeš na internet, vypýtaj si povolenie od rodičov | HU Kérj szülői engedélyt, mielőtt online csatlakoznál! | RO Cere permisiunea părinților înainte de a te conecta online | BG Поискайте разрешение от родител, преди да влезете онлайн | LV Pirms došanās tiešsaistē palūdz atļauju vecākiem | ET Enne Interneti kasutamist küsi vanematelt luba | LT Prieš prisijungdami prie interneto, atsiklauskite tėvų

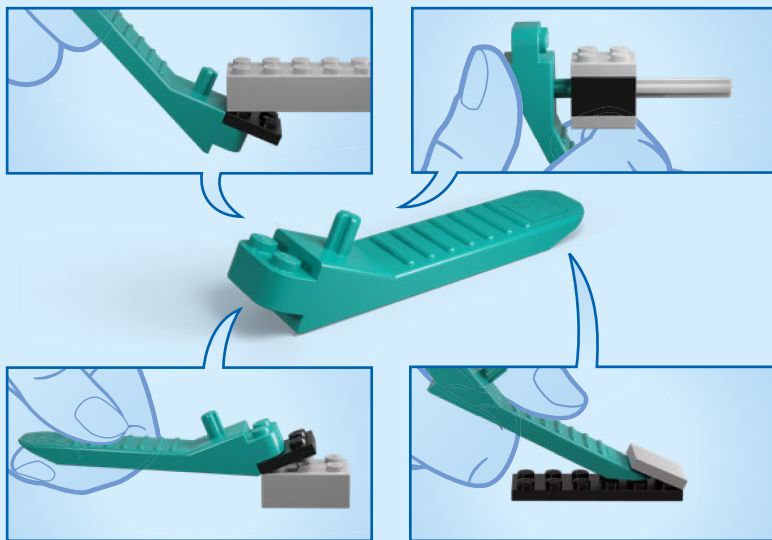



1

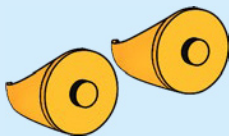

2



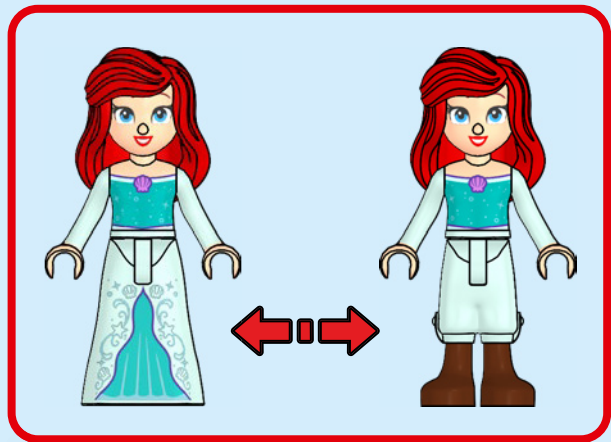
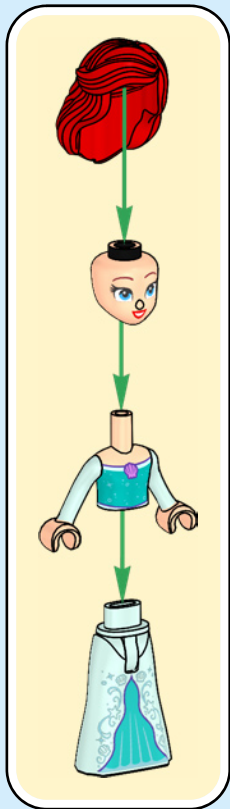

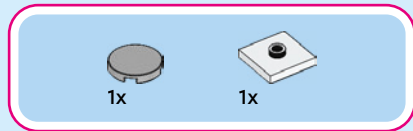
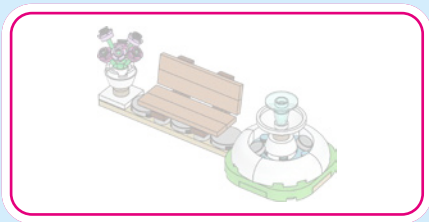

2

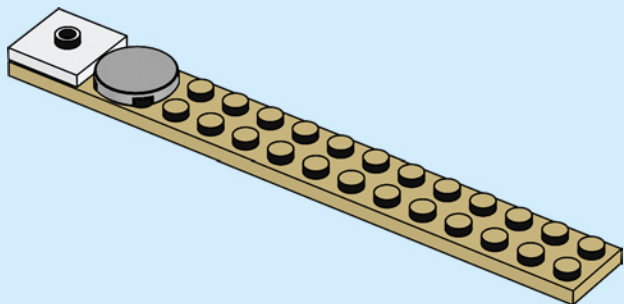
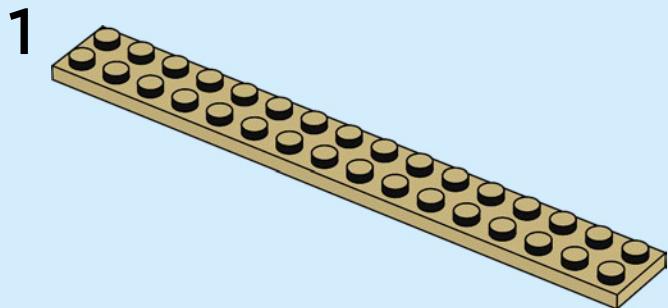
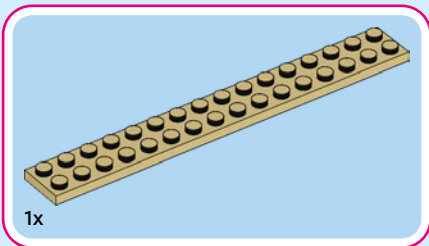



2x



2x

3

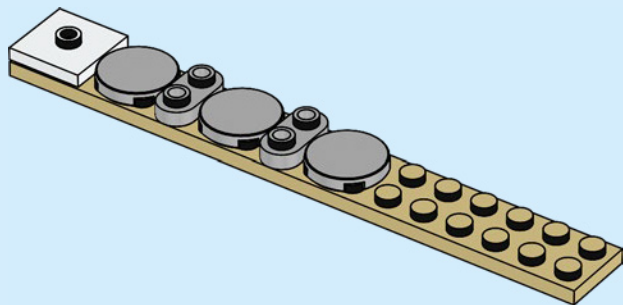

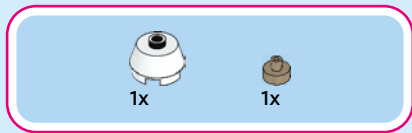

4

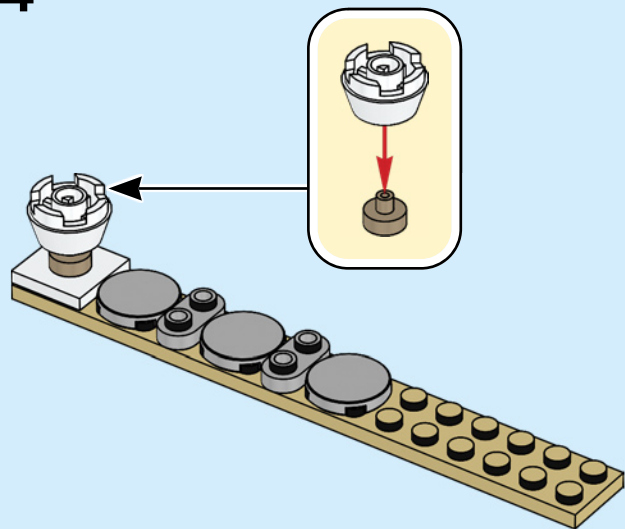

5

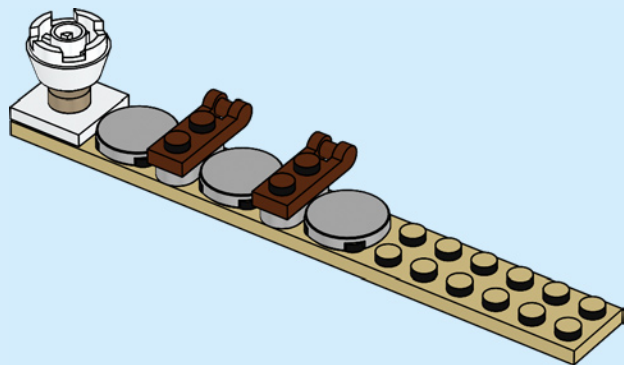



2x

6

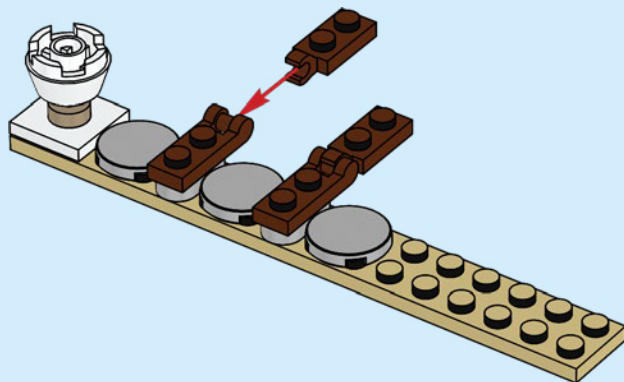

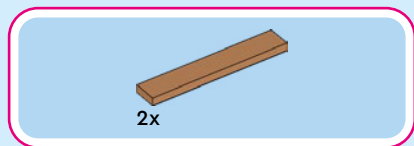

7

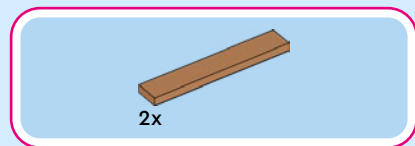
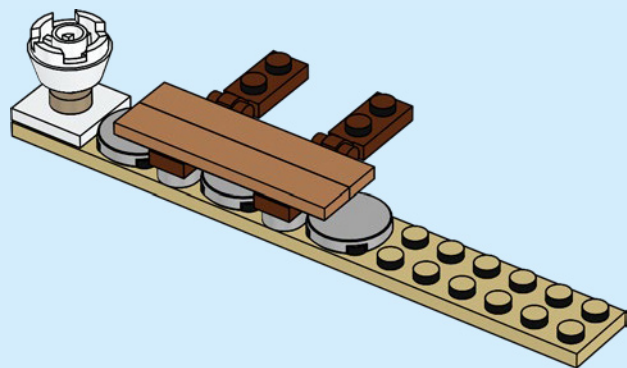

8

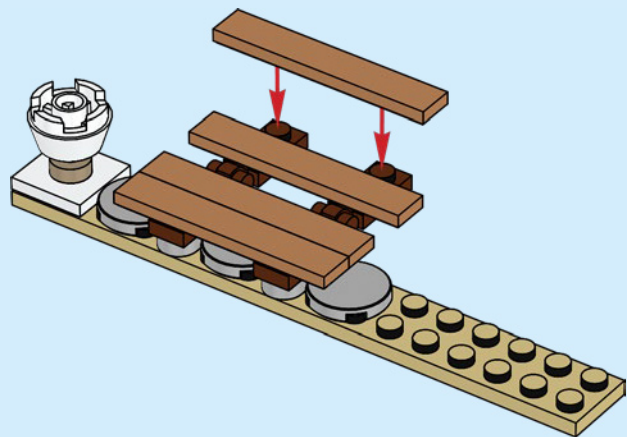

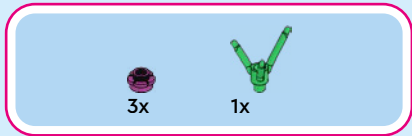

9

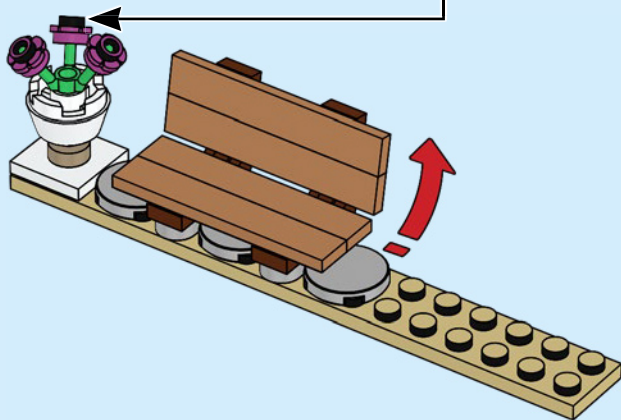
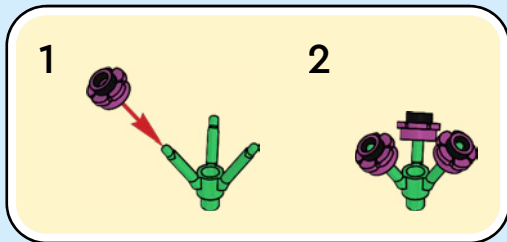

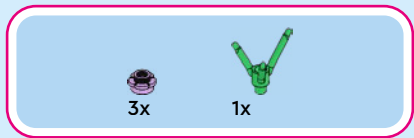

10

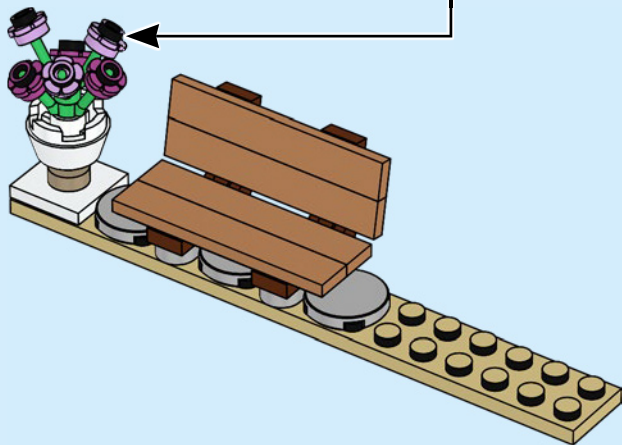
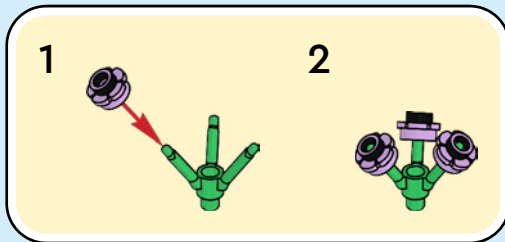

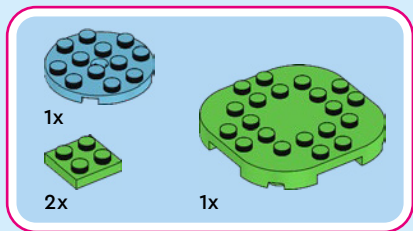

11

1

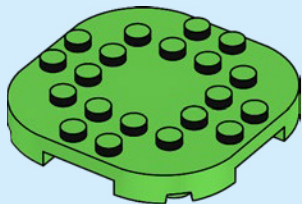

2

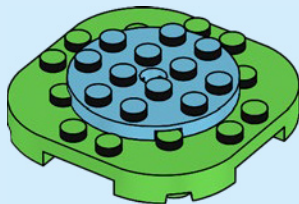

3

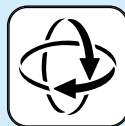
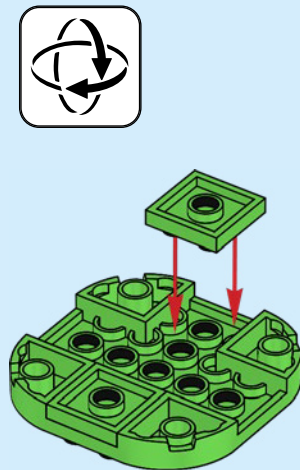

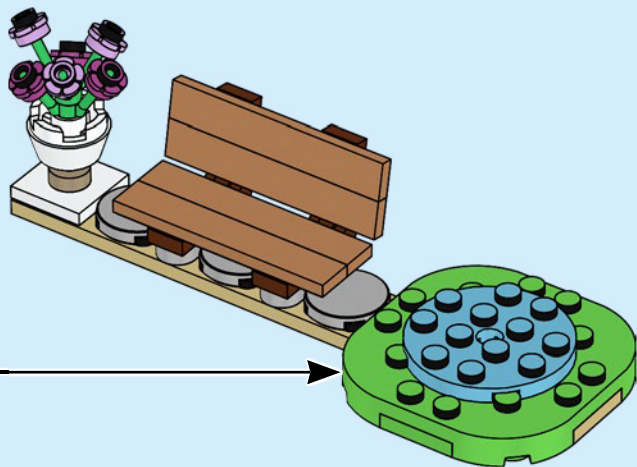



4x

12

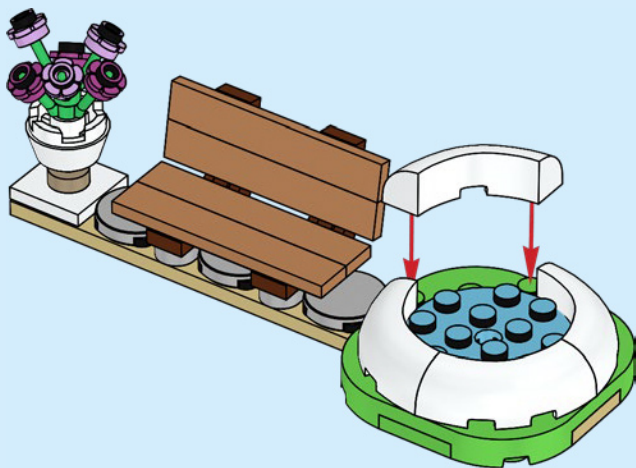



1x



1x

13

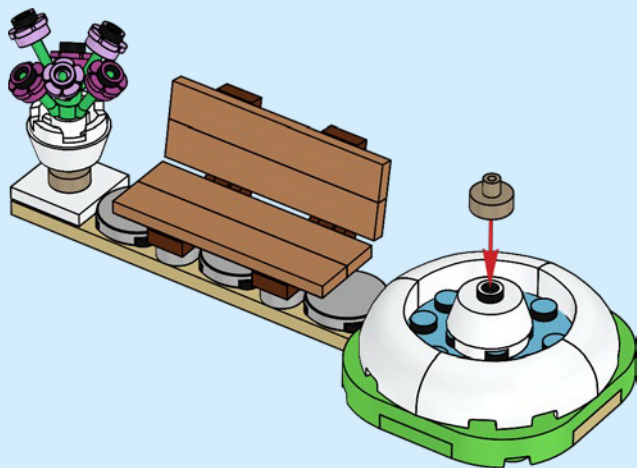



1x

14

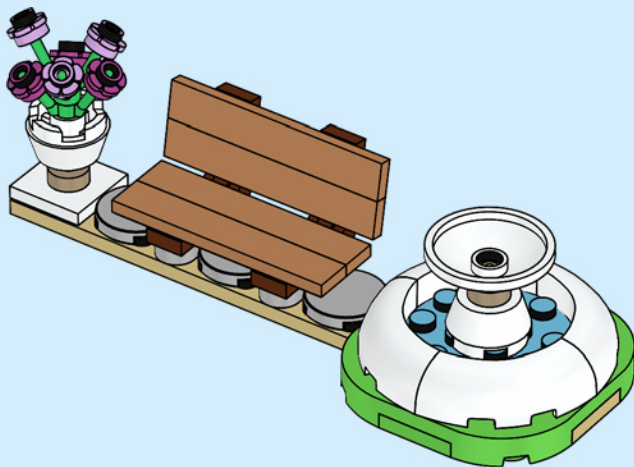



1x



1x

15

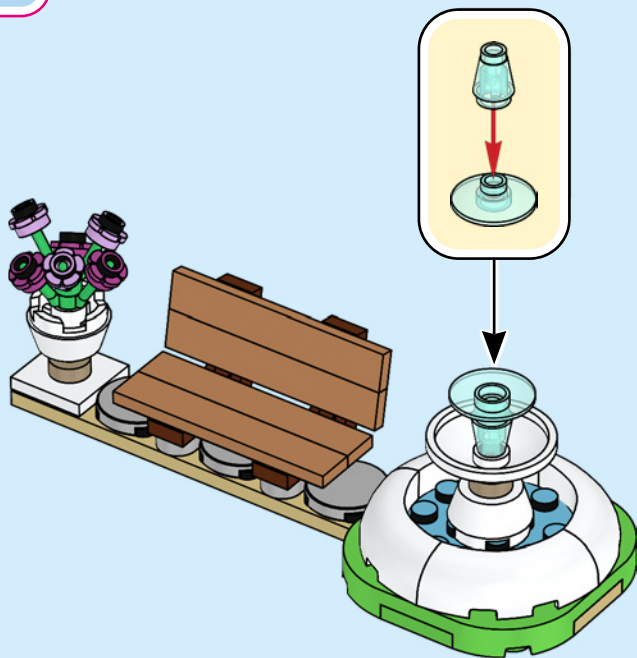



2x

16



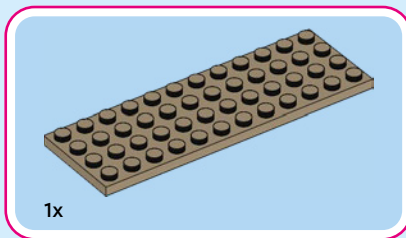

1

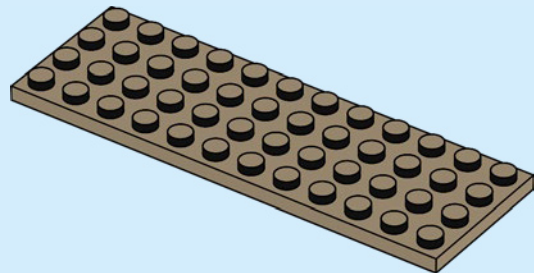

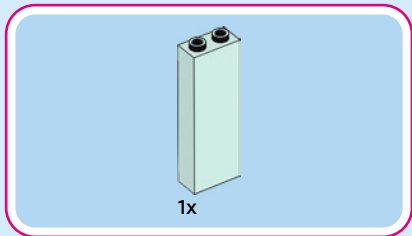

2

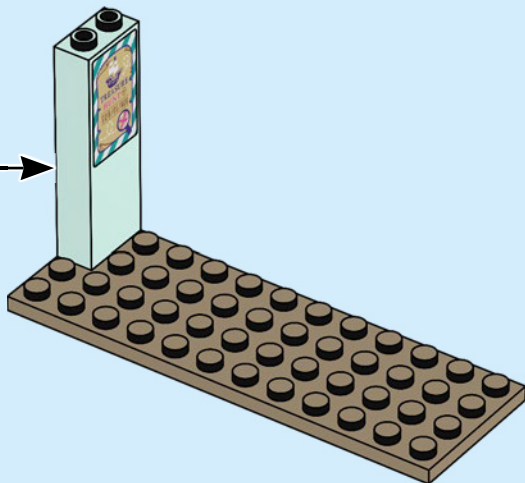
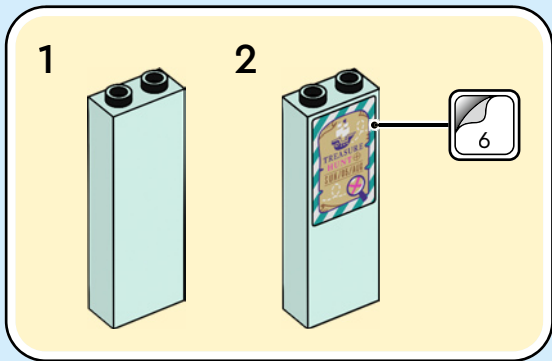

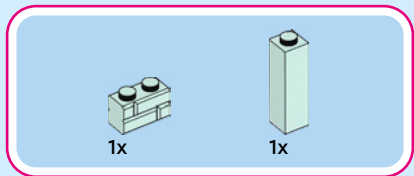

3

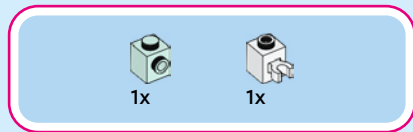
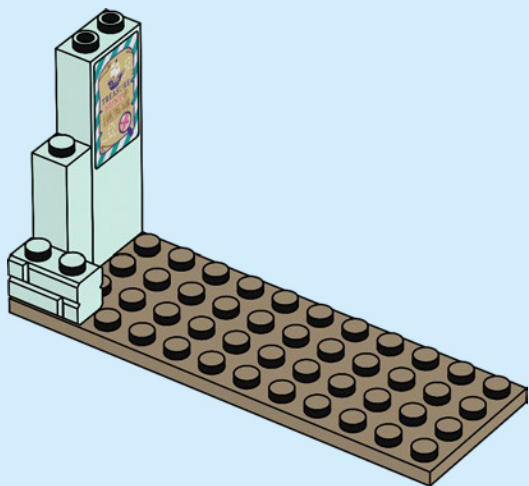

4

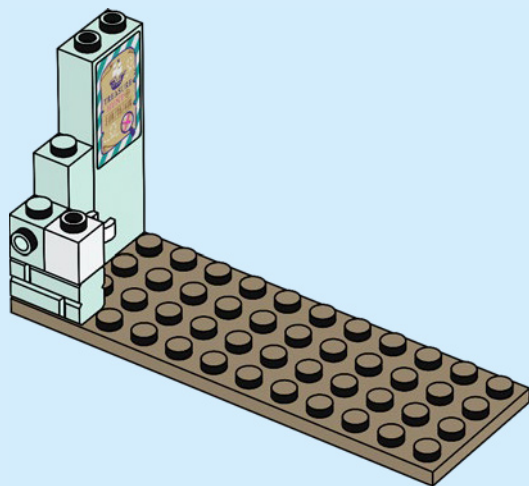



1x

5

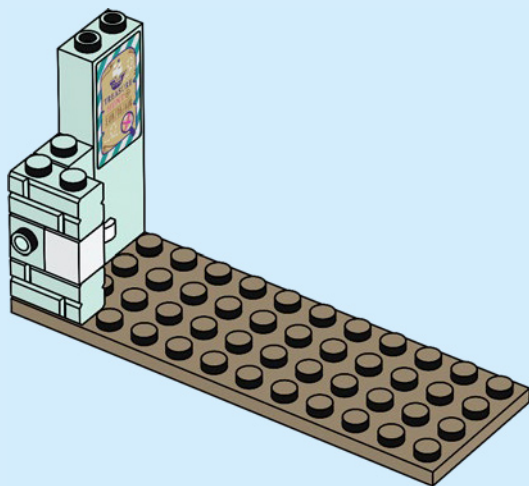



1x

6

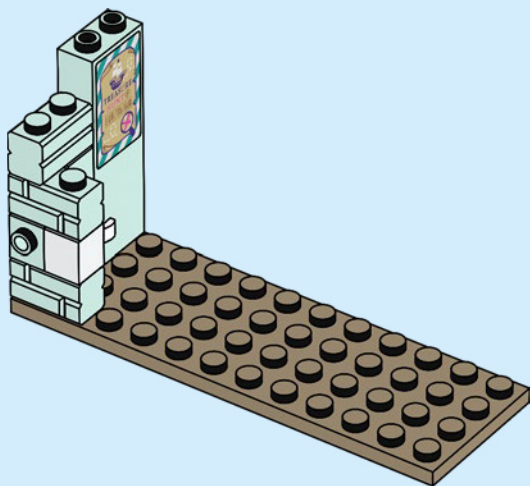

1x

7

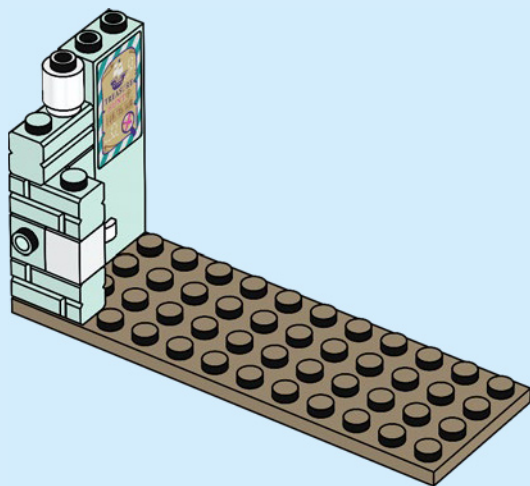



1x



1x

8

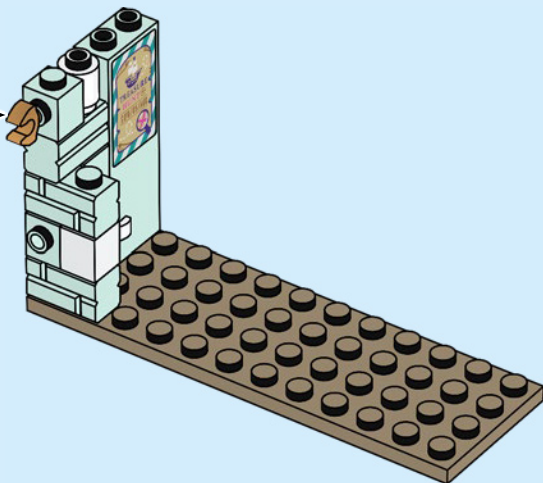
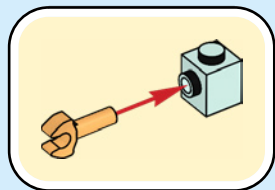

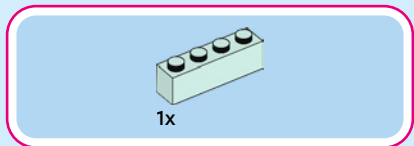

9

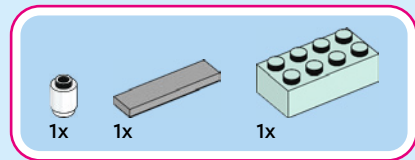
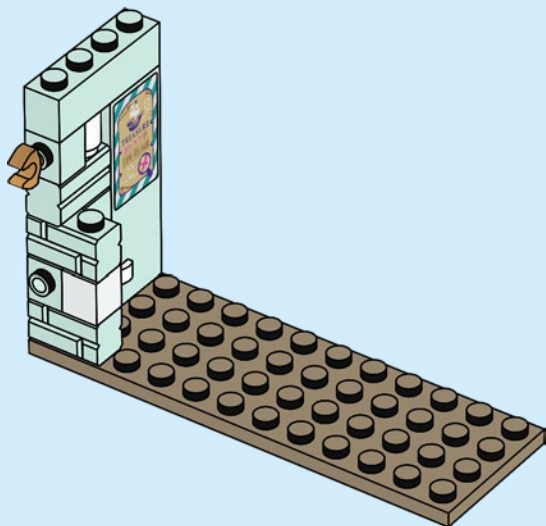

10

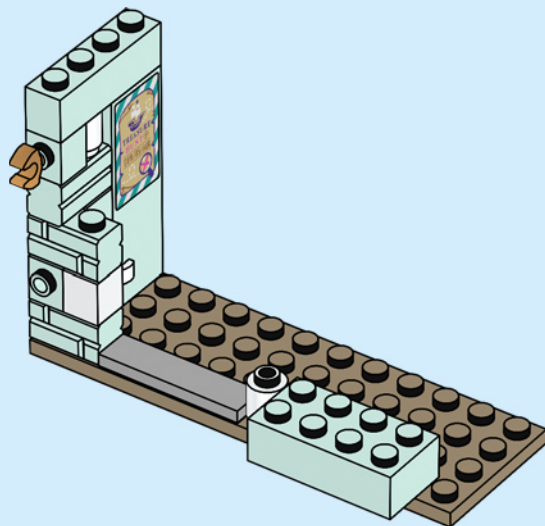



1x

11

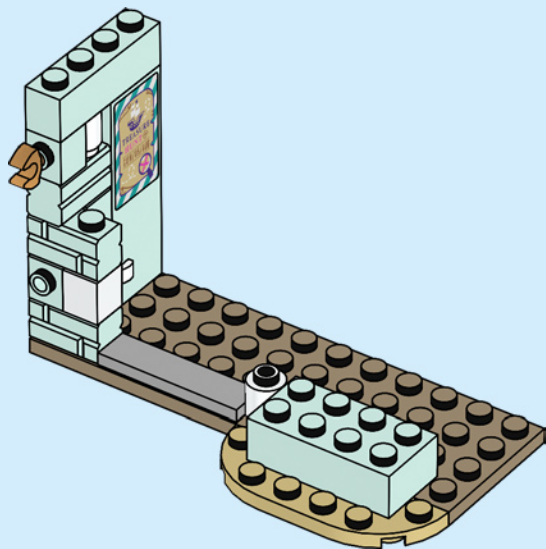



2x

12

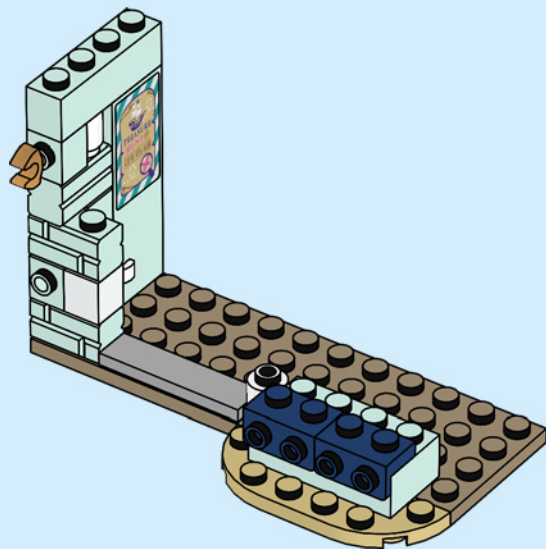

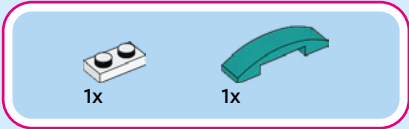

13

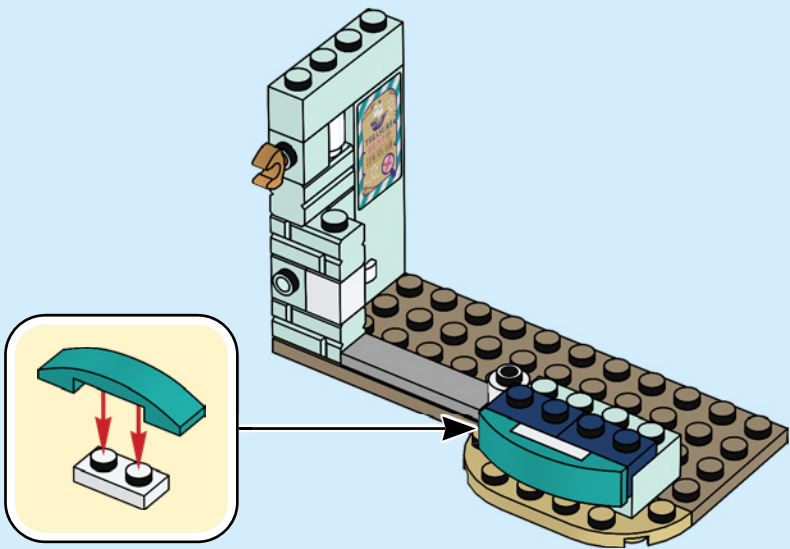

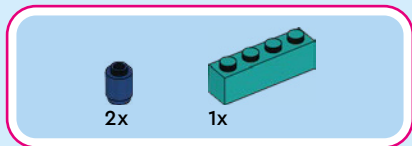

14

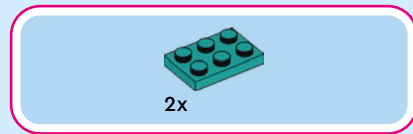
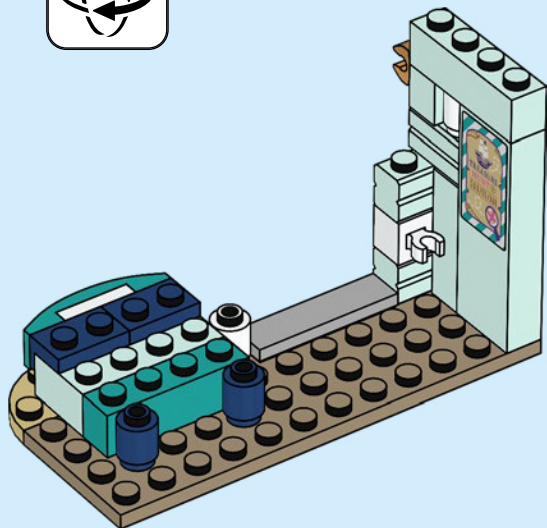

15

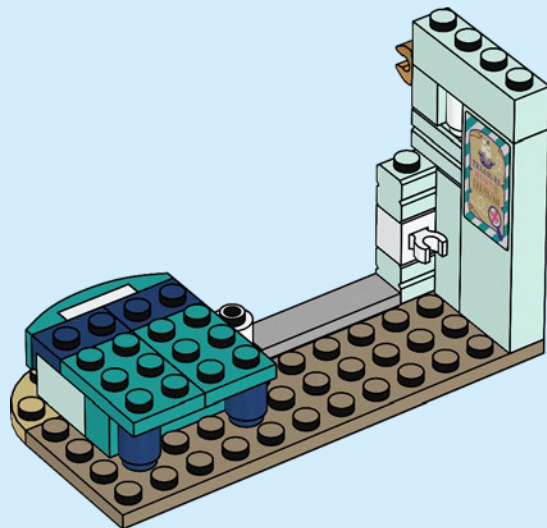



1x

16

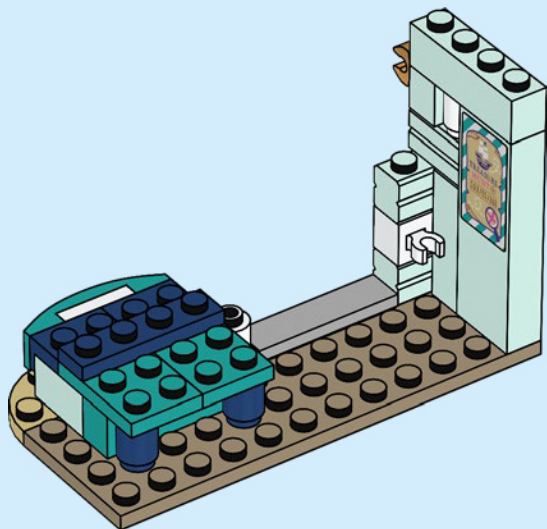

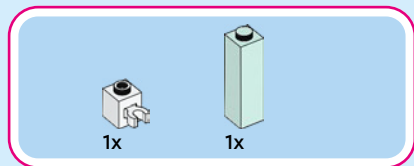

17

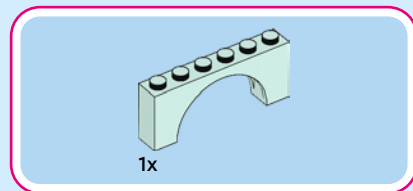
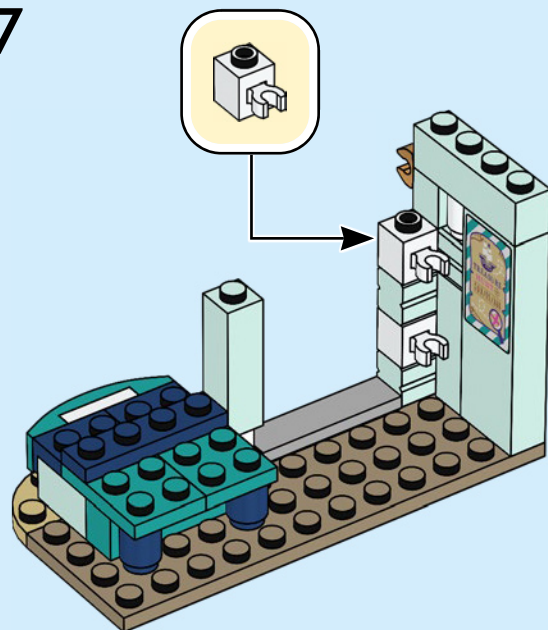

18

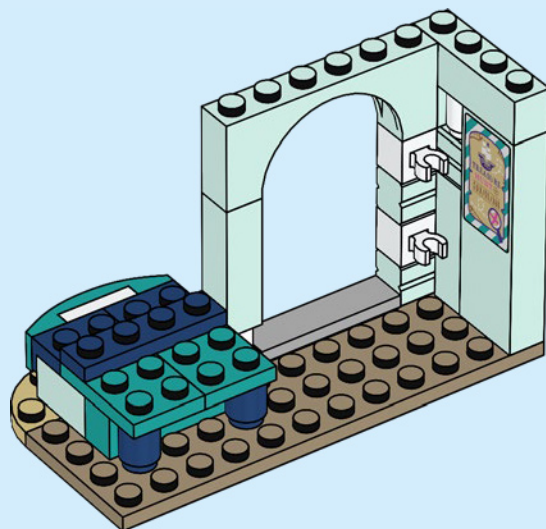

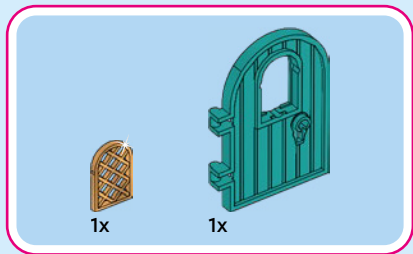

19

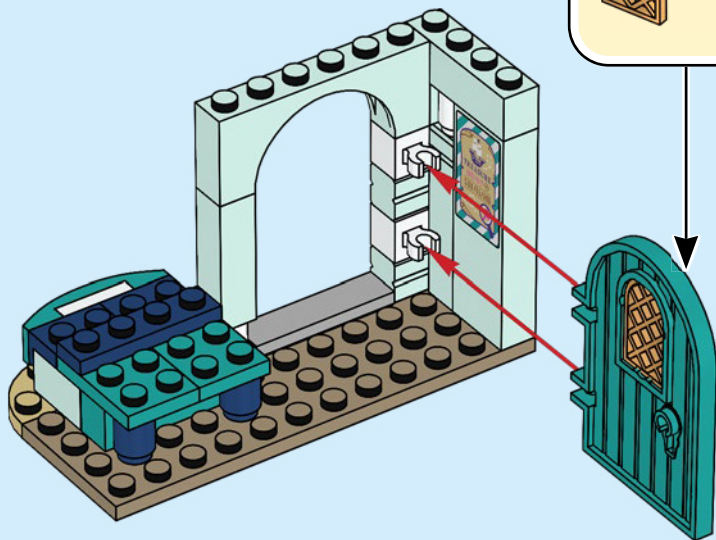



1x



1x

20

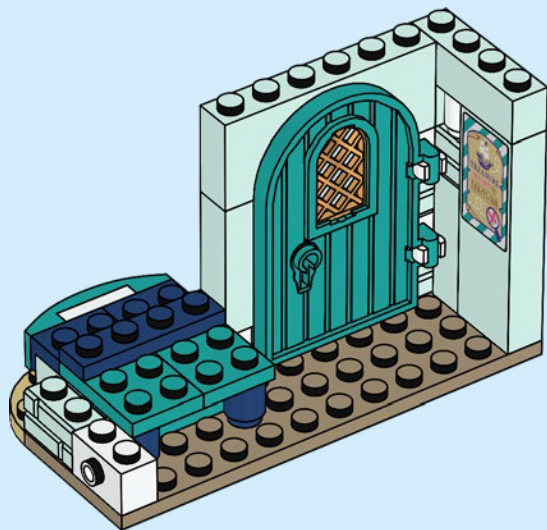

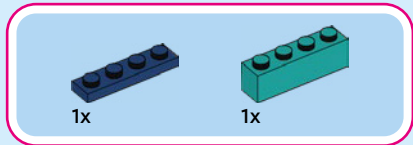

21

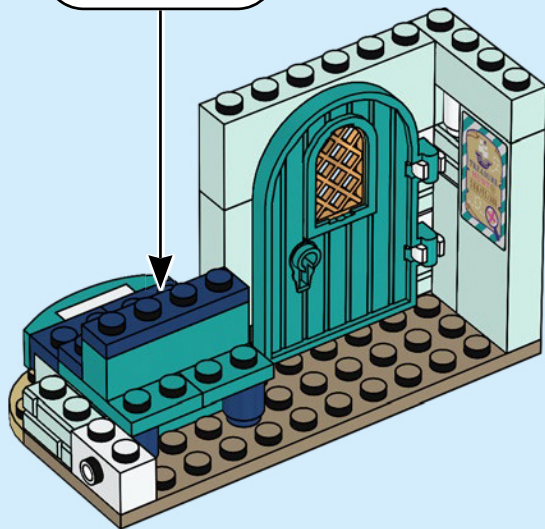
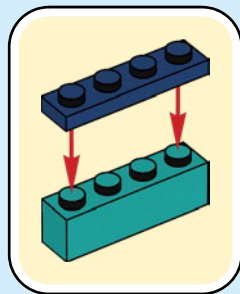



1x



2x

22

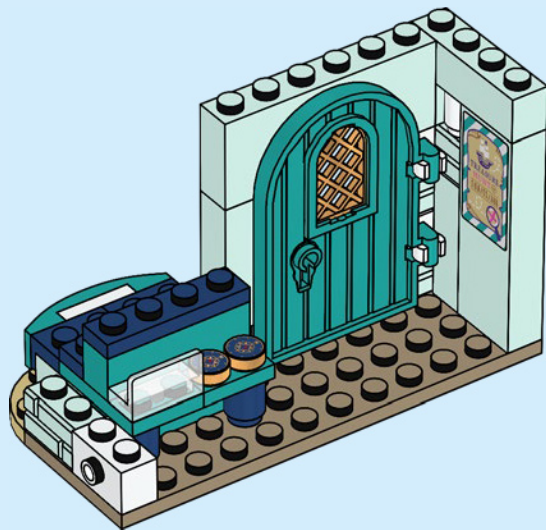

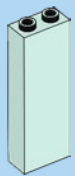

2x

23

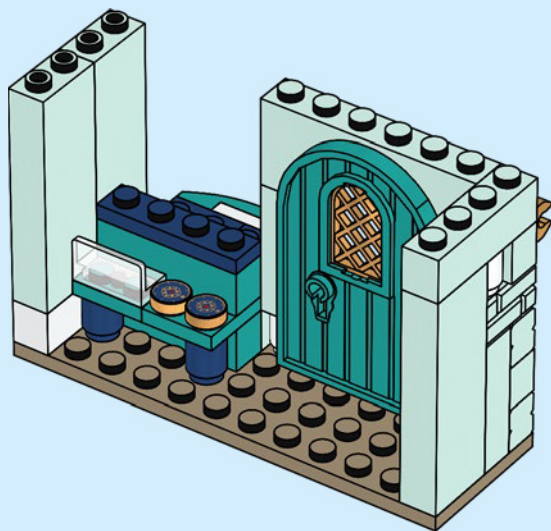



1x



1x



1x

24

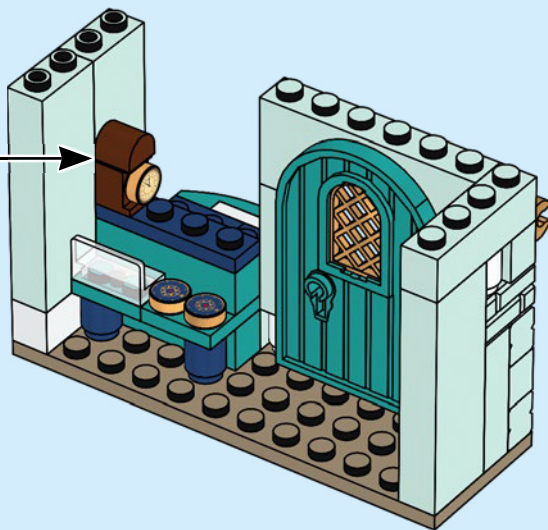
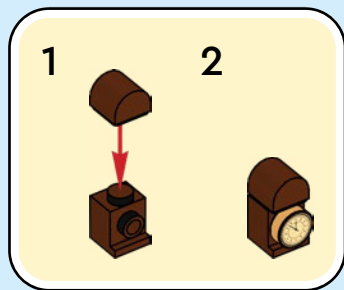

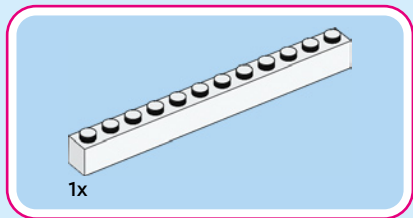

25

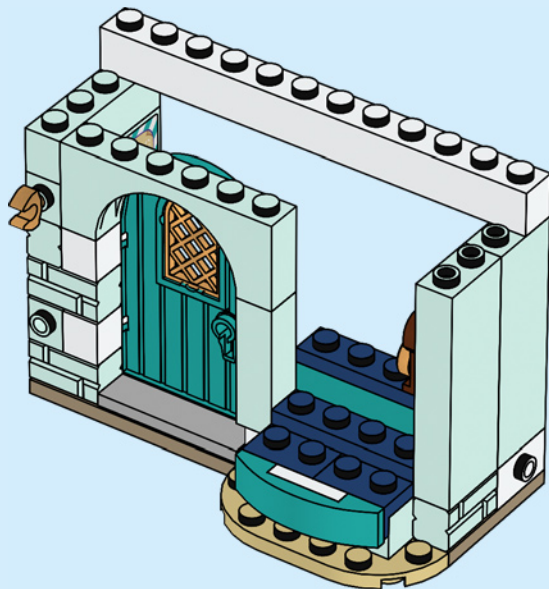



2x

26

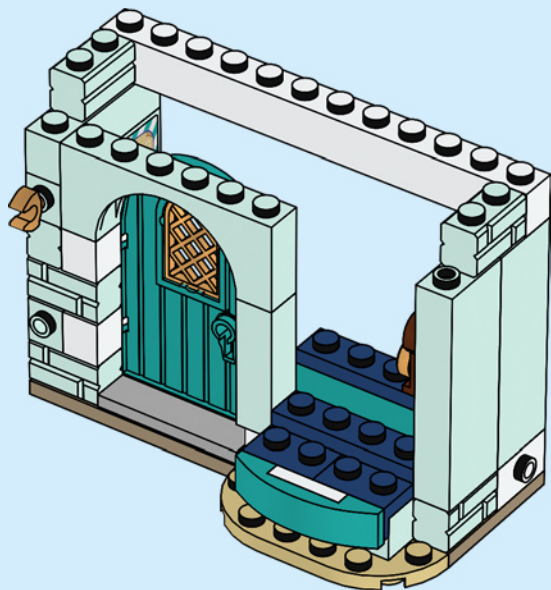



2x



1x

27

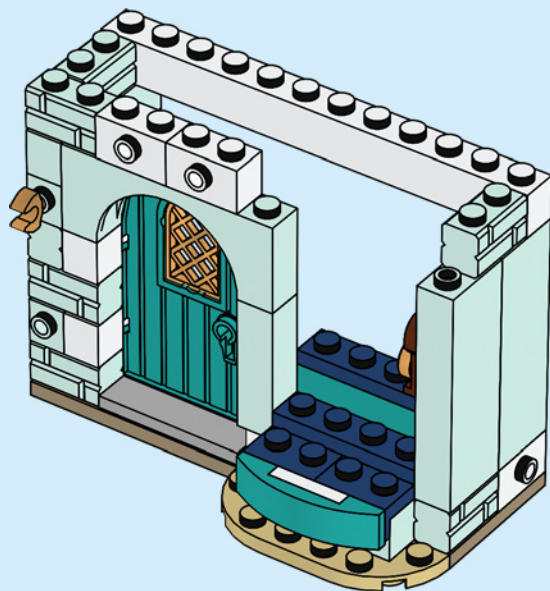

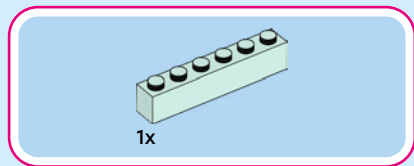

28

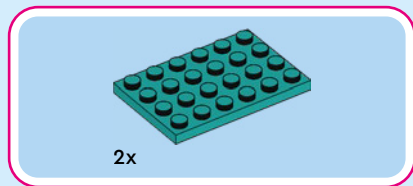
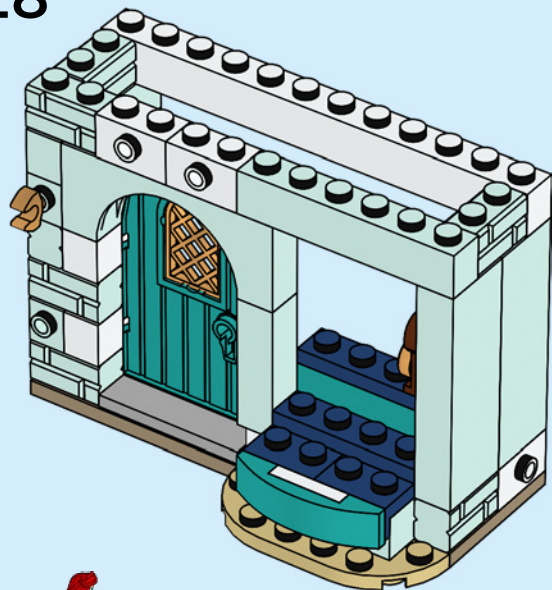

29

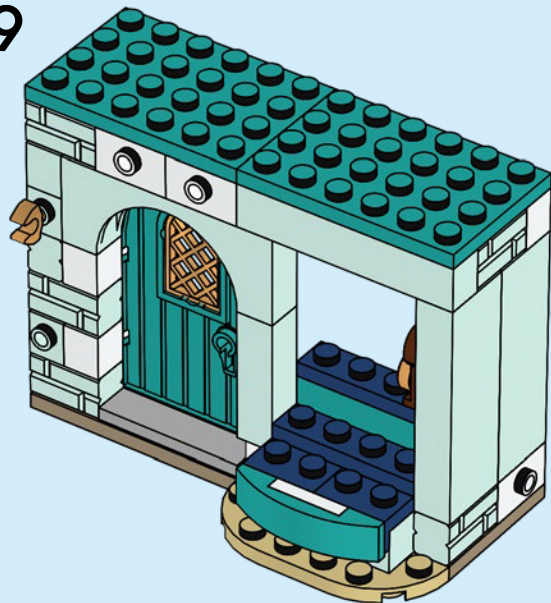



1x



1x

30

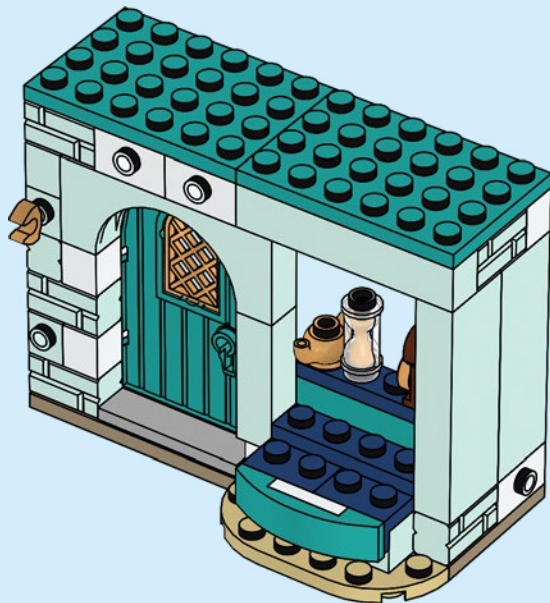



1x



1x

31

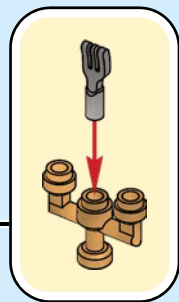
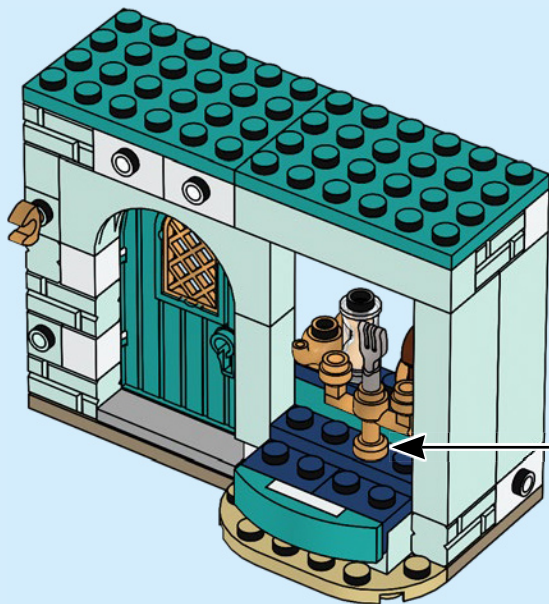



1x



1x

32

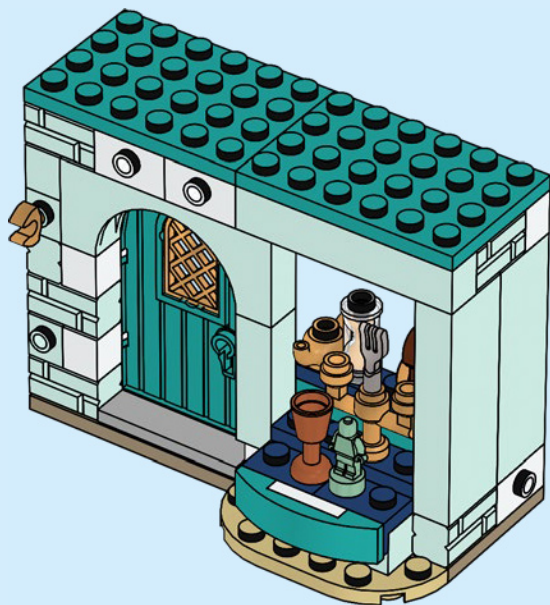



1x



1x

33

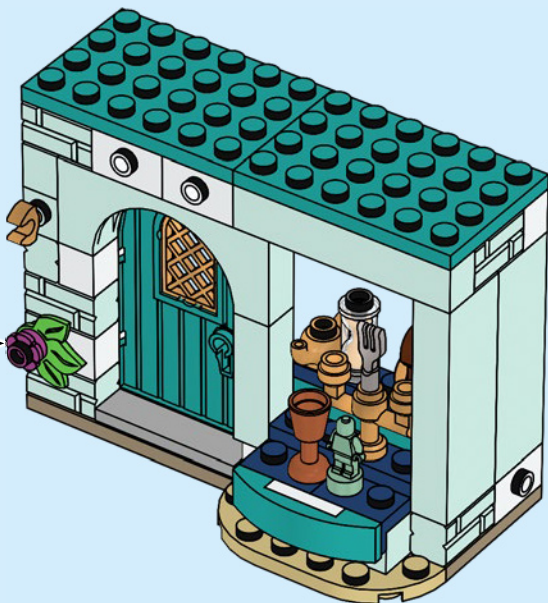
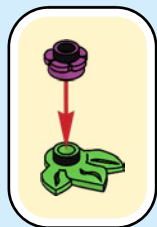

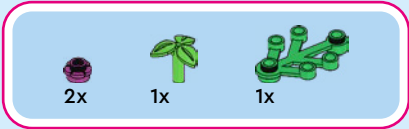

34

1

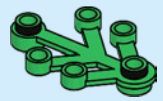

2

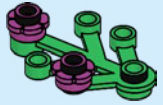

3

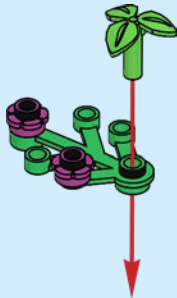



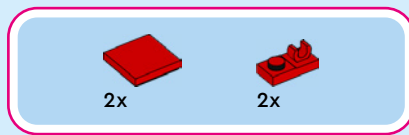

35

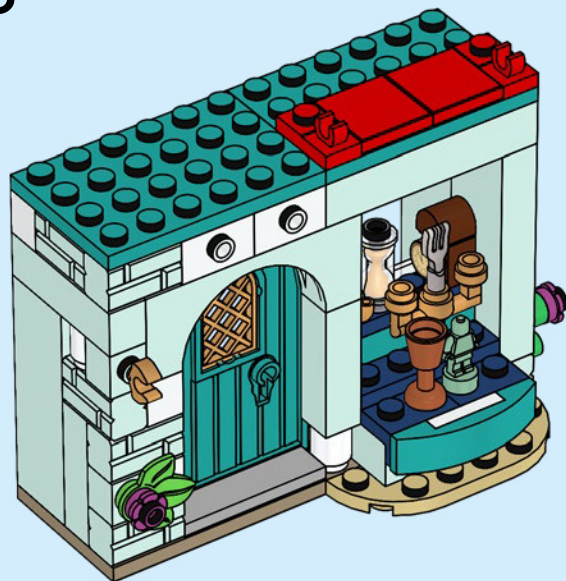



2x

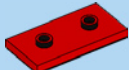

1x

36





2x

37

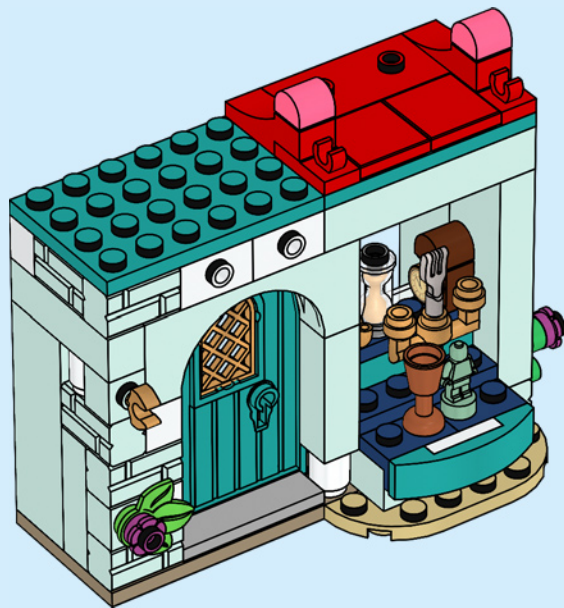

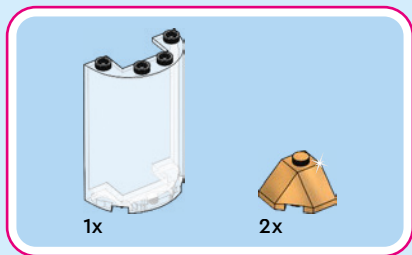

38

1

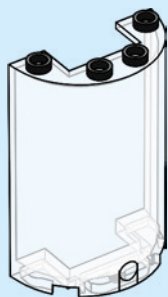

2

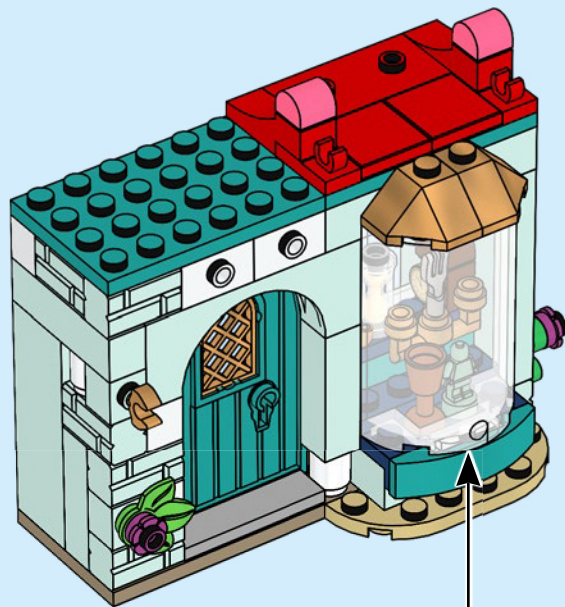
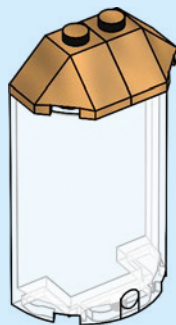



3x

39





1x



1x

40

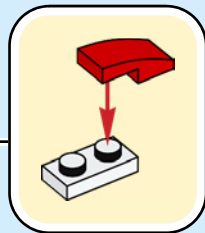



2x



1x



1x

41

1

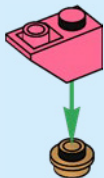

2

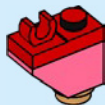

3



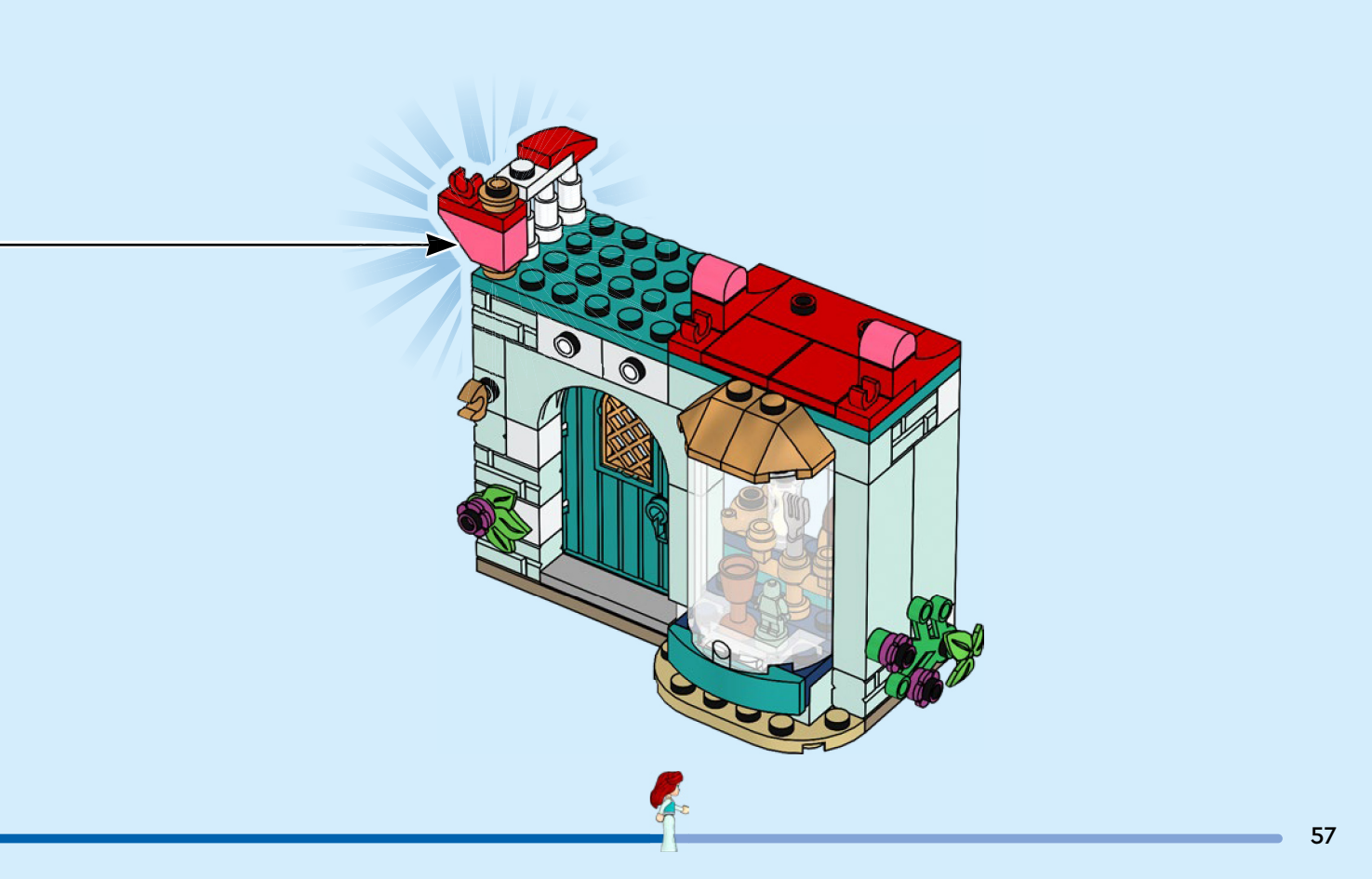

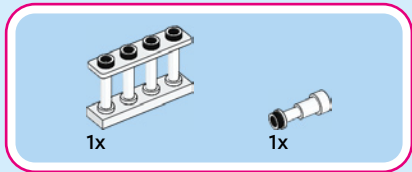

42





1x

43





1x



1x

44



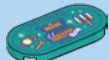

1x

45





46

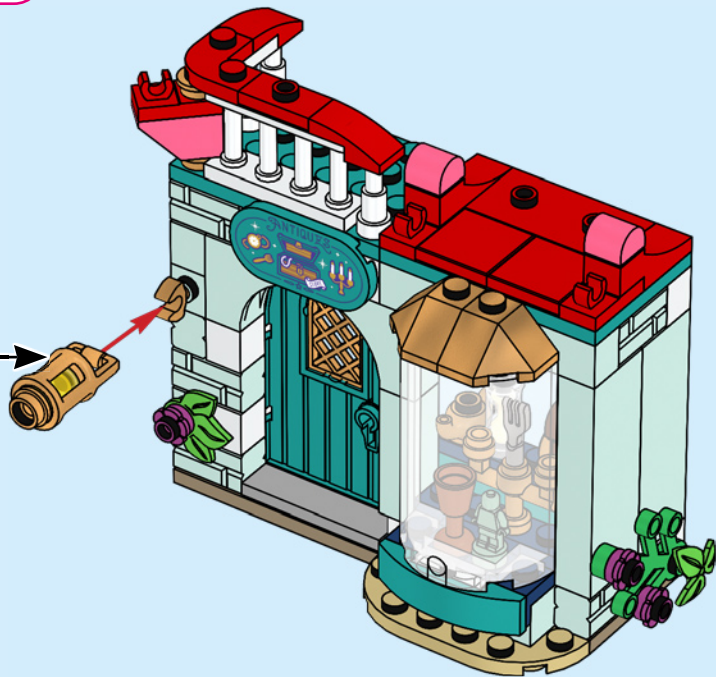
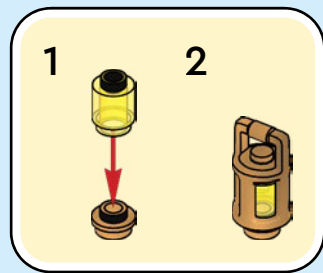



47

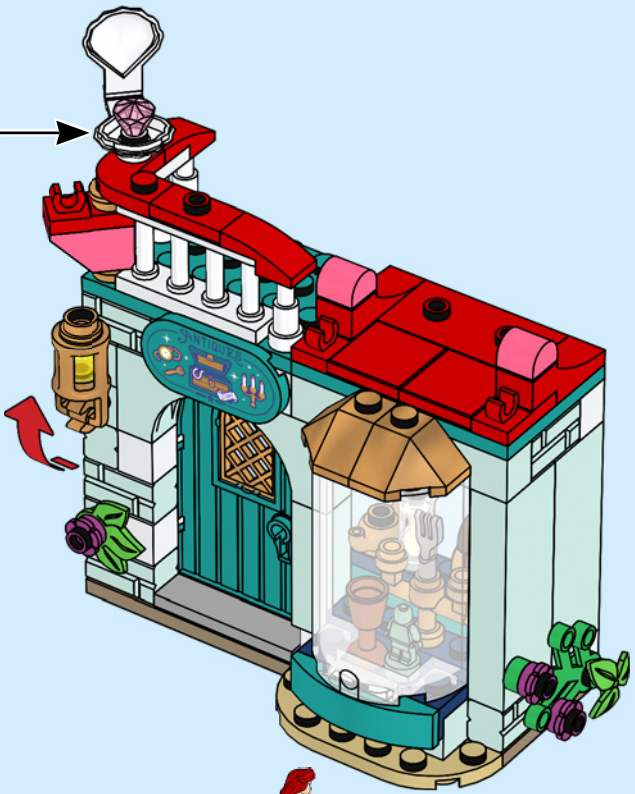
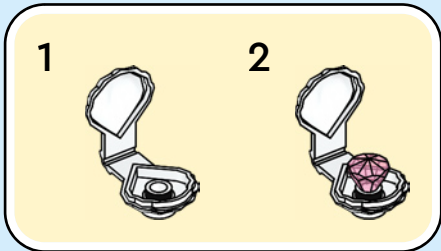

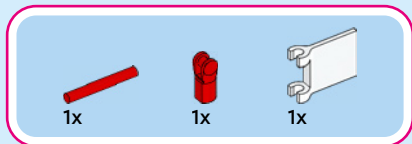

48

1

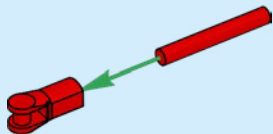

2

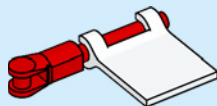

3

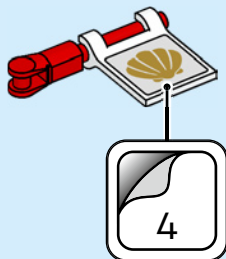

4

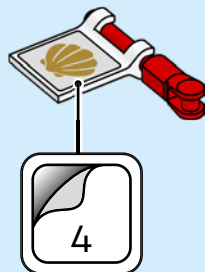
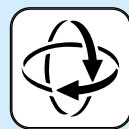

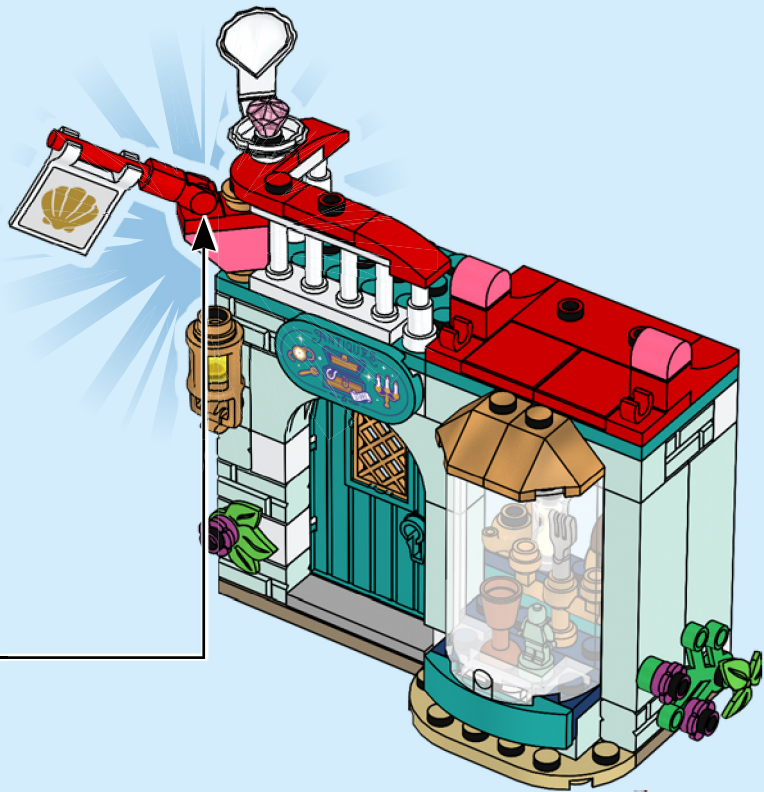

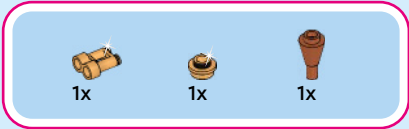

49

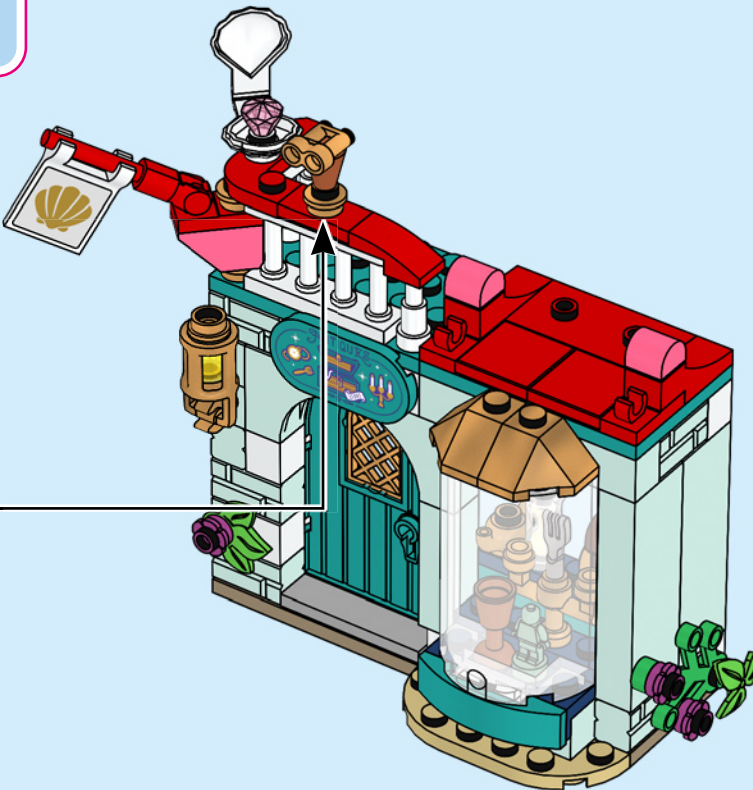
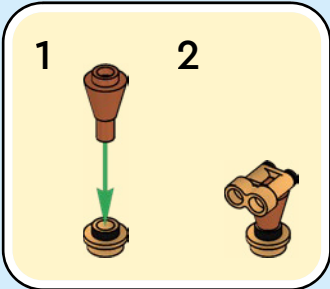

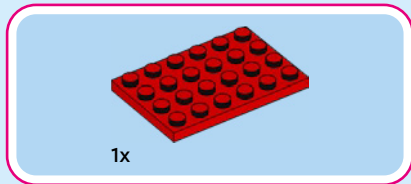

50

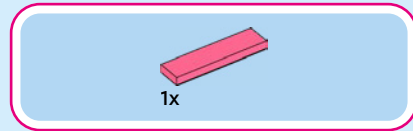
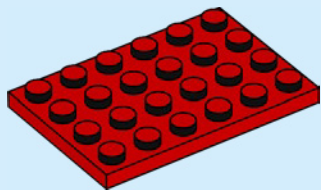

51

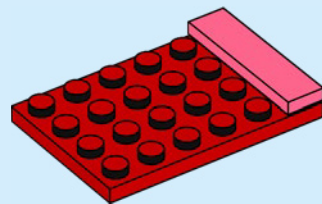



2x



2x

52

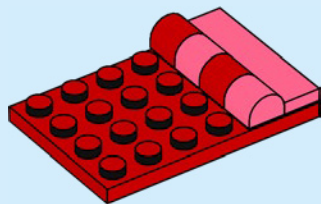

1x

53

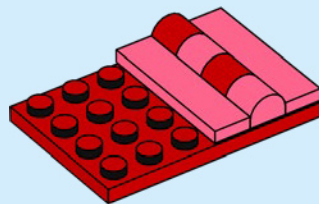



2x



2x

54

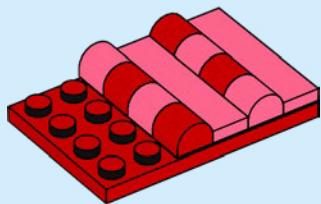

1x

55

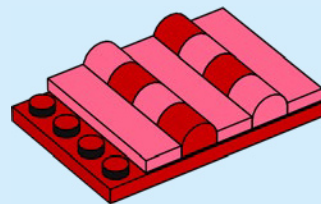



2x



2x

56

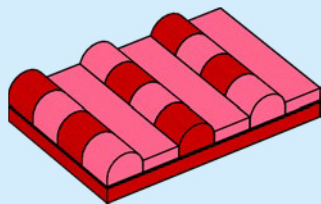

2x

57

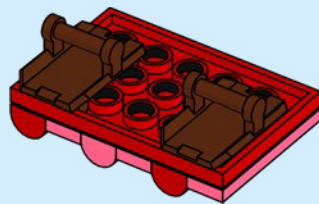

58

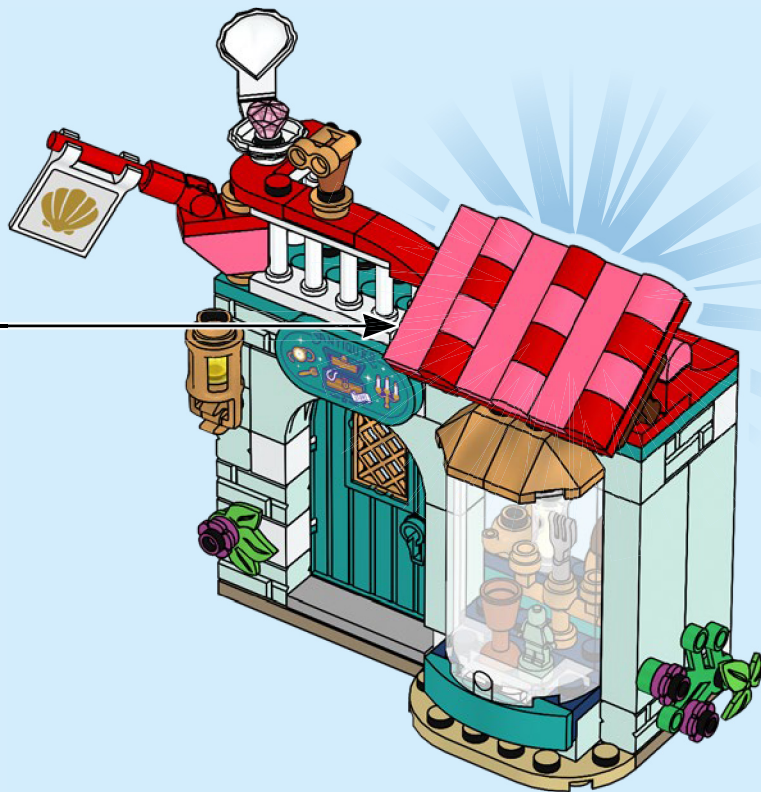

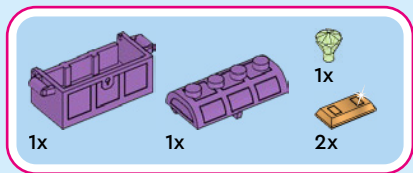

59

1

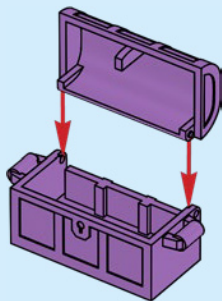

2

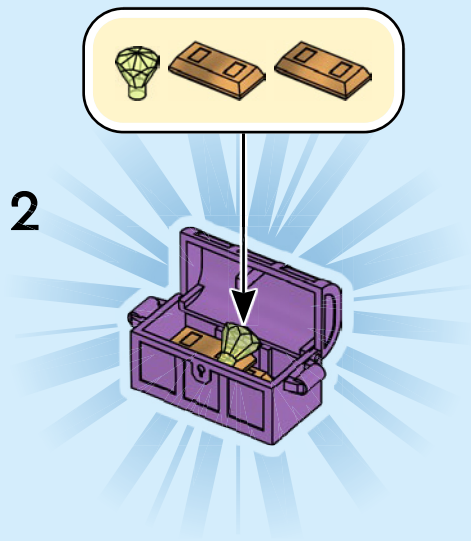





2x

60

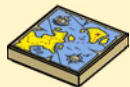

2x







LEGO and the LEGO logo are trademarks of the/son des marques de commerce du/son marcas registradas de LEGO Group.

©2024 The LEGO Group. 6499997

©Disney

Rebuild
the
world™

