



FORGE COC





















MATX GAMING CASE

USER MANUAL BENUTZERHANDBUCH MANUAL DO USUÁRIO РУКОВОДСТВО ПОЛЬЗОВАТЕЛЯ 用户手册

Package Content - Paket Inhalt - Conteúdo do pacote - Содержание пакета - 包装内容

	Image	Q'ty	Used for / Benutzt für / Usado para / Используется для / 用途
A		12	Screws-MB+2,5" SSD / Schrauben-MB+2,5" SSD / Parafusos-MB+2,5" SSD / Винты-МБ+2,5" SSD / 螺丝-МБ+2,5" SSD
B		6	PSU Screw / Stromversorgungsschraube / Parafuso de fonte de alimentação / Винт питания / 电源螺丝
C		4	3.5" HDD Screws / 3,5" HDD-Schrauben / Parafusos do HDD de 3,5 pol. / Винты для жесткого диска 3,5" твердотельного накопителя / 3.5" HDD硬盘螺丝
D		2	Spare Standoff / Ersatz -Standoff / Stoff de reposição / Запасное противостояние / 备用铁柱
E		4	Cable Tie / Kabelbinder / Abraçadeira / Кабельная стяжка / 束线带

Connectors - Anschlüsse - Conectores - Разъемы - 连接器

<p> PORT 1L  AUG GND PORT 1R  PRESENCE PORT 2R  SENSE1_R SENCE_S  SENSE1_L PORT 2L  SENSE2_R </p> 	<p>Combo Audio</p>		<p>POWER SW</p>
<p> VBUS  VBUS SSRX1-  SSRX2- GND  GND SSTX1+  SSTX2+ GND  GND D1-  D2- D1+  D2+ NC </p> 	<p>USB3.0</p>	<p> VCC  VCC D-  D- D+  D+ GND  GND NC  NC </p> 	<p>USB2.0</p>

I/O Panel - N/O Panel - Pannel de N/O - Панель N/O - I/O面板

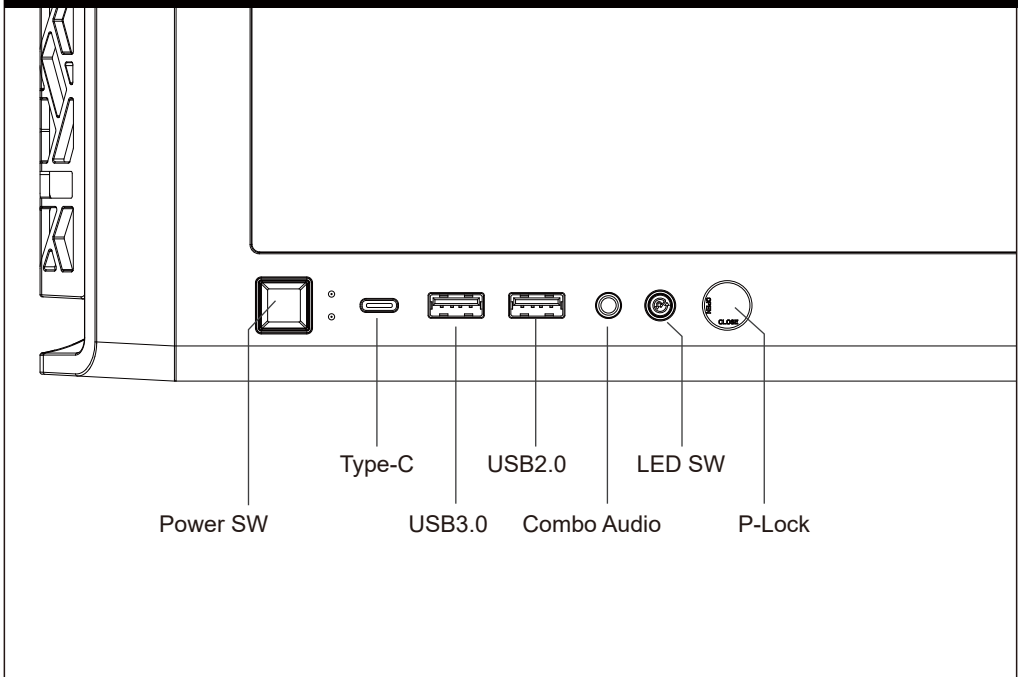

Exploded View - Explosionszeichnung - Vista expandida - В разобранном виде - 爆炸分解图

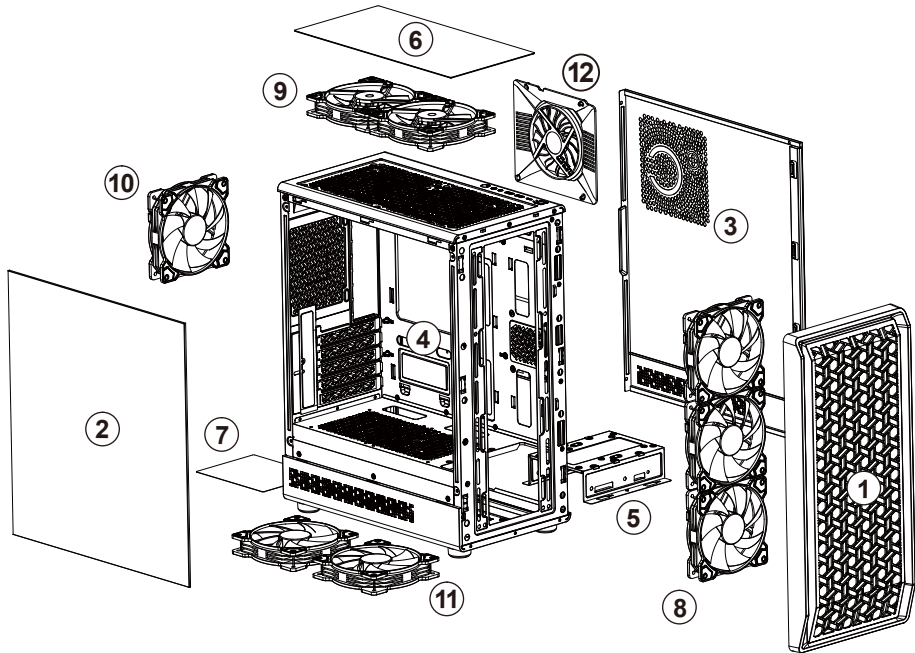

①	Front Panel / Frontblende / Painel frontal / Передняя панель / 面板	⑥	Magnetic dust filter on top / Magnetstaubfilter oben / Filtro de poeira magnética por cima / Магнитный пыли фильтр сверху / 顶部磁吸式防尘网
②	Tempered glass left side panel / Linker Schaltplatte mit geschmiedeten Glas / Painel lateral esquerdo de vidro temperado / Панель левой боковой панели / 钢化玻璃左侧板	⑦	Dust filter at the bottom / Staubfilter unten / Filtro de poeira na parte inferior / Пылевой фильтр внизу / 底部防尘网
③	Right side panel / Rechte Seite / Painel lateral direito / Правая панель / 右侧板	⑧	Front Fan x3(Included) / Front -Lüfter x3(enthaltен) / Fã da frente x3(incluido) / Фронт вентилятор x3(включен) / 前板风扇x3(标配)
④	Chassis / Chassis / Chassis / Шасси / 机架	⑨	Top Fan x2(optional) / Top -Lüfter x2(optional) / Top Fan x2(orcional) / Верхний вентилятор x2 (необязательный) / 顶板风扇x2(选配)
⑤	HDD bracket / HDD -Klammer / Suporte de HDD / Жесткий кронштейн / HDD硬盘架	⑩	Rear fan x1(included) / Heck -Lüfter x1(enthaltен) / Ventilador traseiro x1(incluido) / Задний вентилятор x1(включен) / 后板风扇 x1(标配)
⑪	PSU cover fan x2(optional) / PSU Cover Fan x2(optional) / PSU Cover Fan x2(orcional) / Вентилятор PSU Cover x2(необязательный) / 电源架风扇 x2(选配)		
⑫	COC Turbo Fan x1(included) / COC-TurboLüfter x1(enthaltен) / Ventilador turbo COC x1(incluido) / Турбовентилятор COC x1(включен) / COC涡轮风扇x1(标配)		

Installation Guide - Installationsanleitung - Guia de instalação - Инструкция по установке - 安装指南

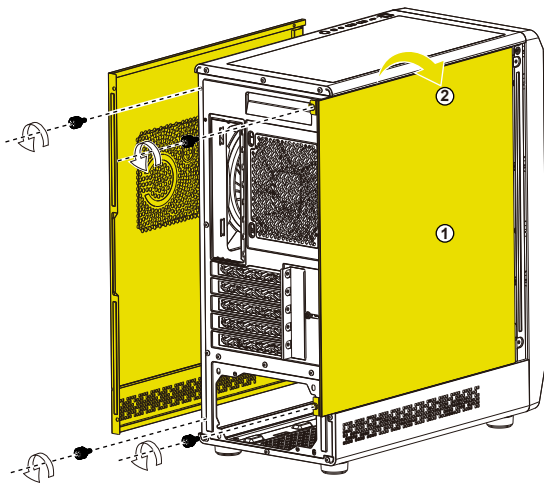

Remove the left and right side panel and bottom plate

Entfernen Sie die linke und die rechte Seitenplatte und die untere Platte

Remova a placa lateral esquerda e direita e a placa inferior

Снимите левую и правую боковую доску и нижнюю пластину

取下左右侧板。

Installation Guide - Installationsanleitung - Guia de instalação - Инструкция по установке - 安装指南

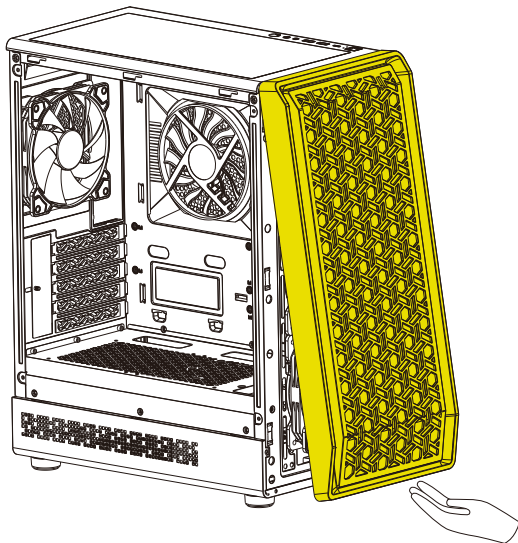

Remove the front panel

*If the fan has been pre-installed in front, no need to remove the panel

Entfernen Sie die Frontplatte

*Wenn der Lüfter vor dem Vorgang vorgegriffen wurde, müssen Sie das Panel nicht entfernen

Remova o painel frontal

*Se o ventilador foi pré-instalado na frente, não há necessidade de remover o painel

Снимите переднюю панель

*Если вентилятор был предварительно установлен впереди, не нужно удалять панель

取下前板

*如果前板已预装风扇，不需要拆面板

Installation Guide - Installationsanleitung - Guia de instalação - Инструкция по установке - 安装指南

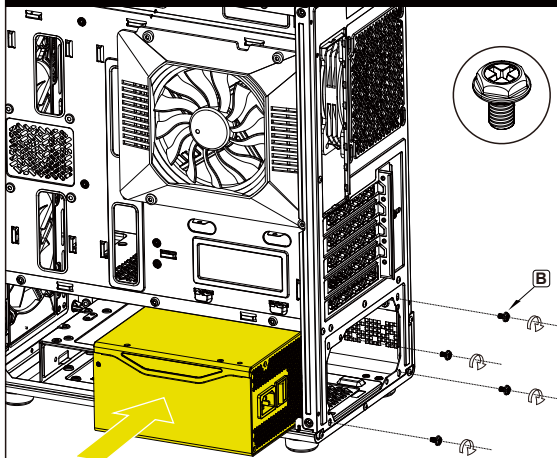

Insert PSU from right side, secure with screws.

Setzen Sie PSU von der rechten Seite ein und sicher mit Schrauben.

Insira a PSU do lado direito, prenda com parafusos.

Вставьте PSU с правой стороны, закрепите винтами.

置入电源，对齐孔位，锁上电源螺丝。

Installation Guide - Installationsanleitung - Guia de instalação - Инструкция по установке - 安装指南

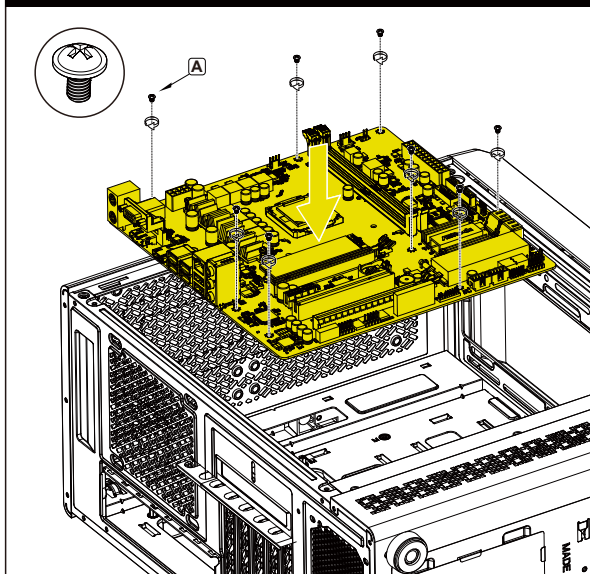

Install the motherboard.

Installieren Sie das Motherboard.

Instale a placa -mãe.

Установите материнскую плату.

安装主板。

Installation Guide - Installationsanleitung - Guia de instalação - Инструкция по установке - 安装指南

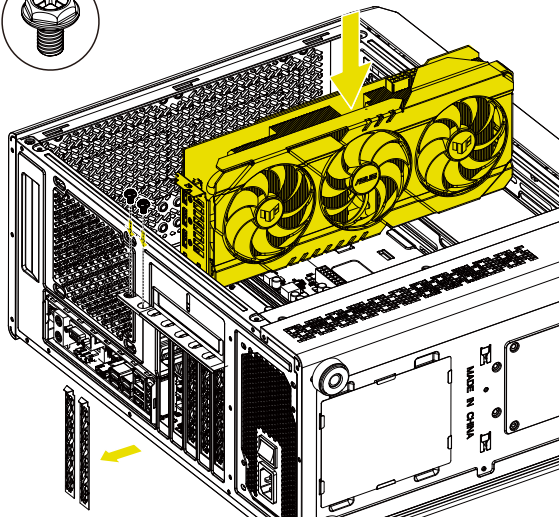
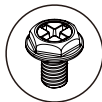

Remove the PCI-E interface card, put it in the graphics card, lock the screw fixation

Entfernen Sie die PCI-E-Schnittstellenkarte, legen Sie sie in die Grafikkarte, sperren Sie die Schraubfixierung

Remova a placa de interface PCI-E, coloque-a na placa de gráfico, bloqueie a fixação do parafuso

Снимите интерфейсную карту PCI-E, поместите ее на видеокарту, заблокируйте фиксацию винта

取下PCI-E界面卡条，放入显卡，锁上螺丝固定

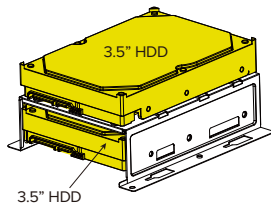
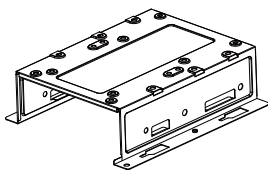

Install 2.5" SSD and 3.5" HDD

Installieren Sie 2.5" SSD und 3.5" HDD

Instale SSD de 2.5" e 3.5" HDD

Установить 2.5" SSD и 3.5" HDD

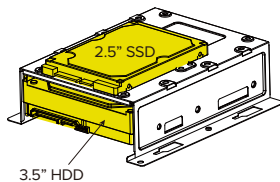
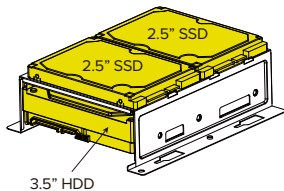

安装2.5" SSD和3.5" HDD

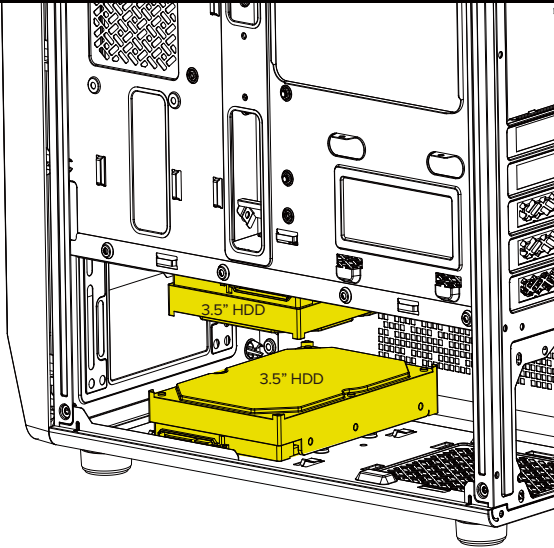

Install 3.5" HDD

Installieren Sie 3,5" HDD

Instale o HDD de 3,5"

Установить 3,5" HDD

安裝3.5" HDD硬盤

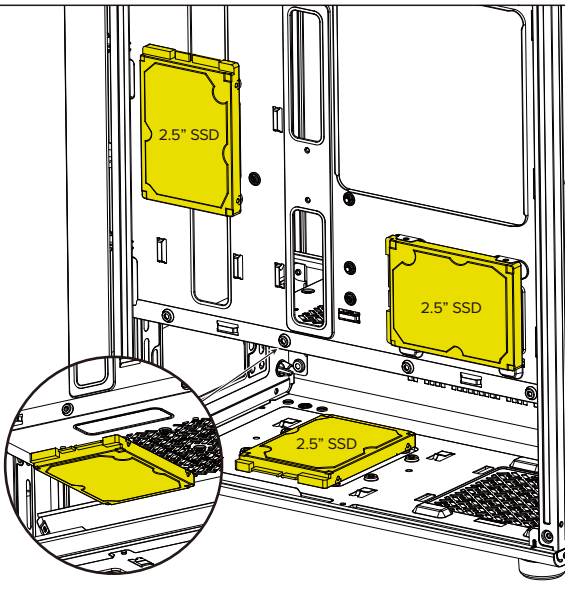

Install 2.5" SSD

Installieren Sie 2,5" SSD

Instale o SSD de 2,5"

Установить 2,5" SSD

安裝2.5" SSD硬盤

Top

120/140mm Fan x2 (optional)
 240mm(RAM Height≤30mm)
 Liquid cooling system (optional)

Rear

120mm Fan x1 (included)
 120mm Liquid cooling system (optional)

M/B

140mm COC Turbo Fan x1 (included)

Front

120mm Fan x3 (included) / 140mm Fan x2(optional)
 120/140/240/280/360mm
 Liquid cooling system (optional)

Bottom

120mm Fan x2 (optional)

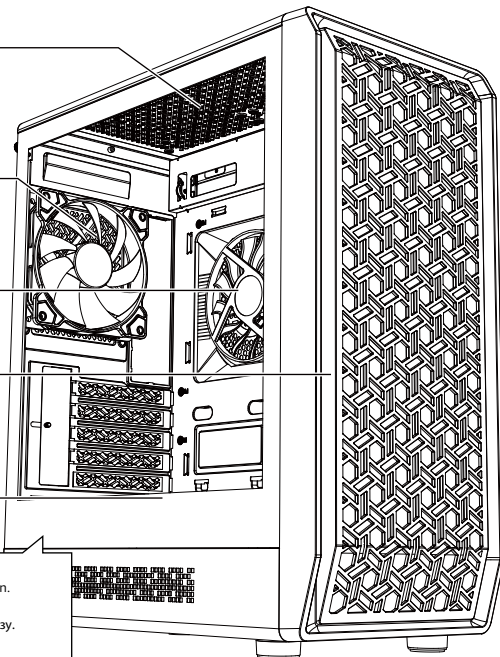

It is recommended to use a reverse blade fan at the bottom.
 Es wird empfohlen, unten einen Anti-Blade-Lüfter zu verwenden.
 Recomenda-se usar um ventilador anti-lâmina na parte inferior.
 Рекомендуется использовать вентилятор с антилопастями внизу.
 推荐底部使用反叶风扇

ARGB Fan Connection Instruction

ARGB-Lüfteranschluss-Anleitung / Instruções de conexão do ventilador ARGB / Инструкция по подключению вентилятора ARGB / ARGB风连接说明

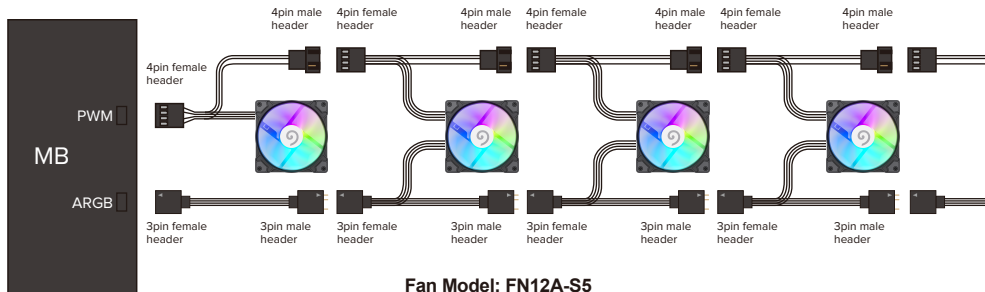

Fan Model: FN12A-S5

COC Turbo Fan Connection Instruction

COC-Turbolüfter-Anschlussanleitung / Instruções de conexão do ventilador turbo COC / Инструкция по подключению турбовентилятора COC / COC涡轮风扇连接说明

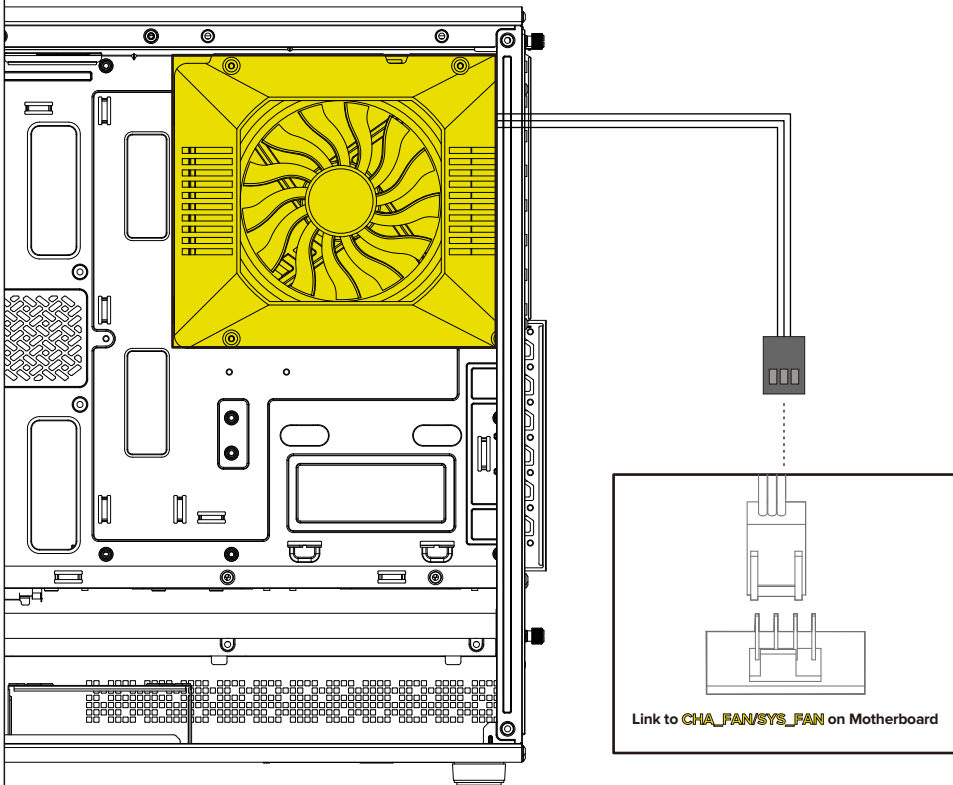



Power Up with gamemax, Gaming to the Max!



www.gamemaxpc.com