

 **User Manual**

ANYCUBIC PHOTON D2

Dear customer,

Thank you for choosing **ANYCUBIC** products.

Maybe you are familiar with 3D printing technology or have purchased **ANYCUBIC** printers before, we still highly recommend that you read this manual carefully. The installation techniques and precautions in this manual can help you avoid any unnecessary damage or frustration.

Please visit <https://support.anycubic.com> to contact us if you have any question. You can also gain more information such as software, videos, models from the website.



ANYCUBIC support center

Team **ANYCUBIC**

Copyrighted by "Shenzhen Anycubic Technology Co., Ltd ", all rights reserved.

Safety Instructions

Always follow the safety instructions during assembly and usage, to avoid unnecessary damage to the 3D printer or individual injury



Please contact our customer service first if you have any issue after receiving the products.



Be cautious when using the scraper. Never direct the scraper towards your hands.



In case of emergency, please immediately cut off the power of **ANYCUBIC** 3D printer and contact the technical support. **DO NOT unplug ANYCUBIC 3D printer when it is working.**



ANYCUBIC 3Dprinter includes moving parts that can cause injury.



It is recommended to use protection glasses when sanding the printed models to avoid eye contact with small particles.



Keep the **ANYCUBIC** 3D printer and its accessories out of the reach of children.



Vapors or fumes may be irritating at operating temperature. Always use **ANYCUBIC** 3D printer in an open and well ventilated area. Do not use or place **ANYCUBIC** 3D printer in dusty environment for a long time.



ANYCUBIC 3D printer must not be exposed to water or rain.



Operate **ANYCUBIC** 3D printer with a temperature of 8°C-40°C and a humidity of 20%-50%. For optimal performance, do not exceed this range. Also, avoid direct sunlight exposure.



Do not disassemble **ANYCUBIC** 3D printer, please contact technical support if you have any question.

Contents

1. Technical Specification	5
2. Packing List	7
3. Product Overview	8
4. Menu Directory.....	9
5. Assembly and Leveling Instructions	12
6. First Print Instructions	15
7. Slicing Software Overview	17
8. FAQ and Machine Maintenance	19

Technical Specification

Printing

System	Anycubic Photon D2
Operation	2.8-inch Color TFT Screen
Software	Anycubic Photon Workshop
Connectivity	USB memory stick

Specifications

Technique	Digital Light Projection
Light Source	UV-LED (wavelength 405nm)
Resolution	2560*1440 (2K)
XY Accuracy	51 μ m
Z-axis Accuracy	0.01 mm
Suggested Layer Thickness	0.01-0.15 mm
Print Speed	Max 2.5s/layer
Rated power	15 W

Physical Dimensions

Dimension	236 mm (L) *226 mm (W) *438 mm (H)
Build Volume	130.6 mm(L)*73.4mm(W) *165 mm (H)
Materials	405nm UV-resin for DLP 3D printer
Net Weight	~5 kg









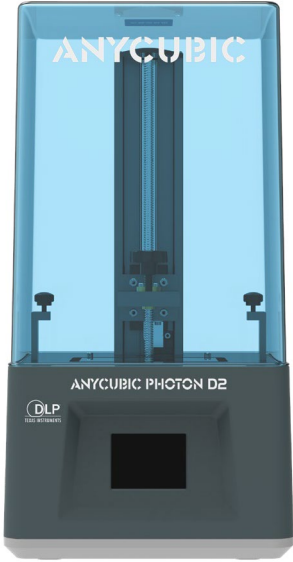
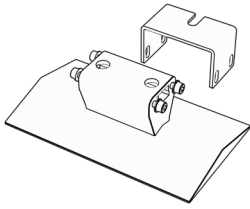
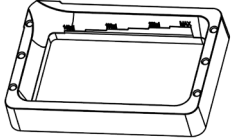

Technical Specification

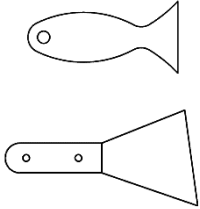
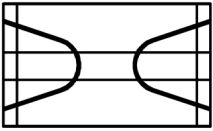
Recommended Printing Parameters

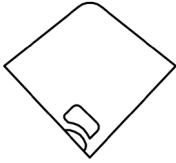
Parameters \ Resin type	DLP Craftsman Resin				
	White	Black	Aqua Blue	Beige	Grey
Normal Exposure Time (s)	2.3	2.5	2.7	2.3	2.3
Off Time (s)	1				
Bottom Exposure Time (s)	28				
Bottom Layers	5				
Z Lift Distance (mm)	5				
Z Lift Speed (mm/s)	2				
Z Retract Speed (mm/s)	3				
Anti-alias	16				
Note	<p>1. The bottom exposure time should be adjusted according to the size of model and the wear of printing platform's surface.</p> <p>2. The surface of printing platform may be worn after long-term use. If the model do not stick to platform or the edge of model lift, please increase the bottom exposure time by 20%-50% or increase the friction of platform's surface by sanding.</p>				



Packing List

			
	Print platform 1PC	Resin vat 1PC	
			
Anycubic Photon D2	USB memory 1PC	Scrapers 2PCS	
			
Mask 1PC	Gloves 3Pairs	Funnel 5PCS	Assembly instruction 1PC
			
Power adapter 1PC	Tool kit	Clean kit	Leveling paper 1PC

Product Overview

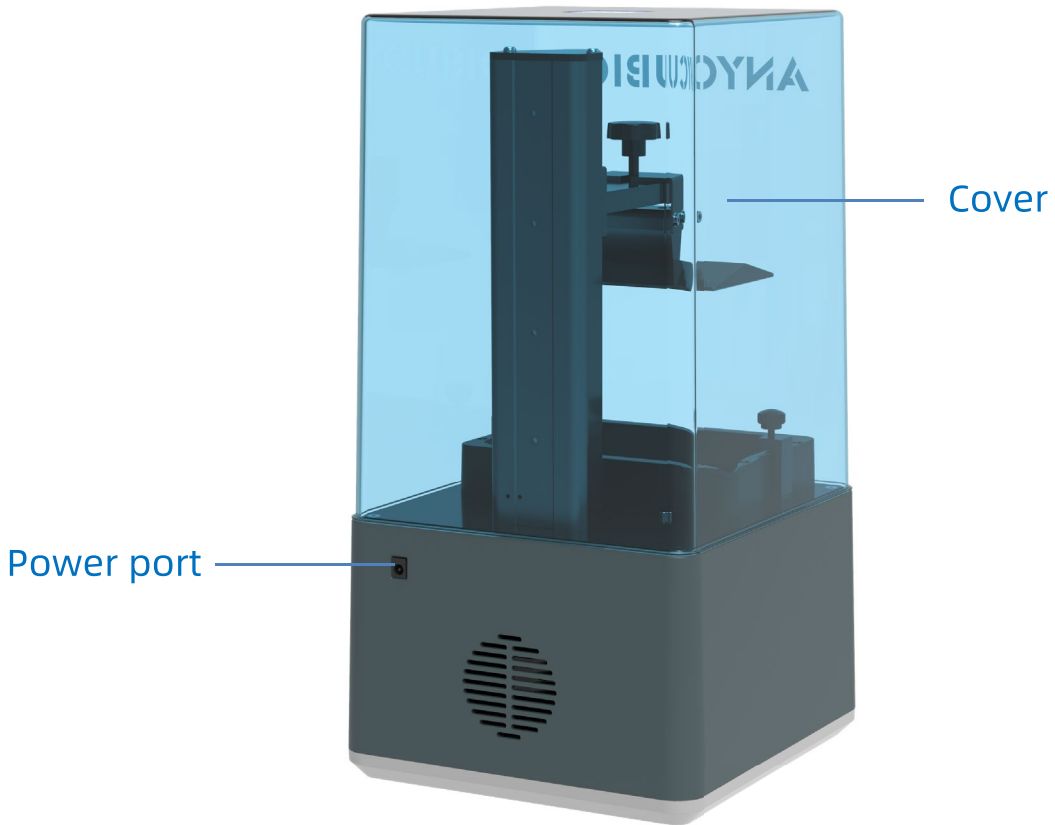
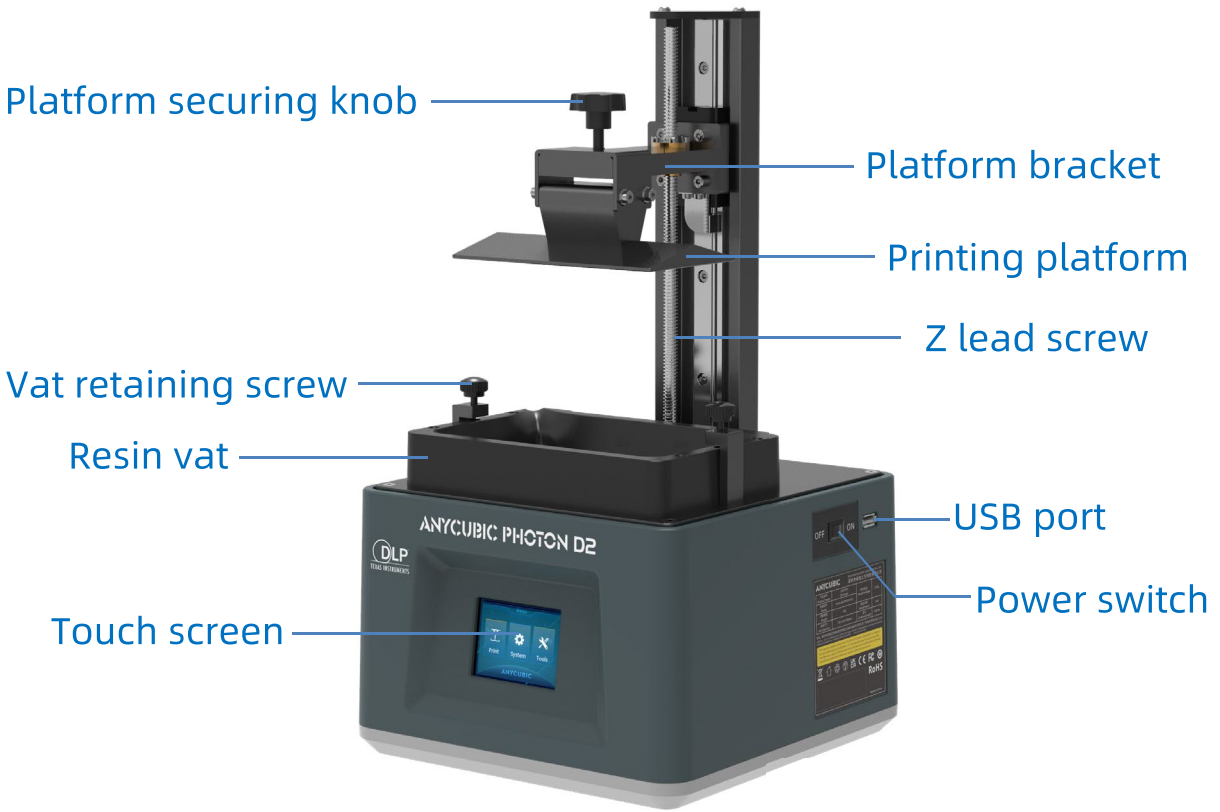

Menu Directory

Home menu



Print



System



Tools



Home menu



Menu Directory

Print

File List:

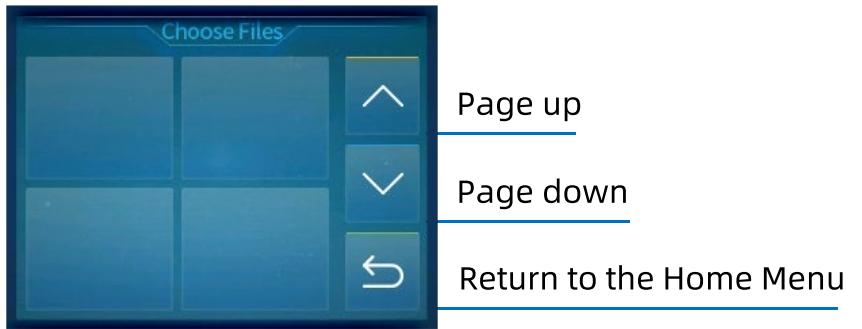

Click Files

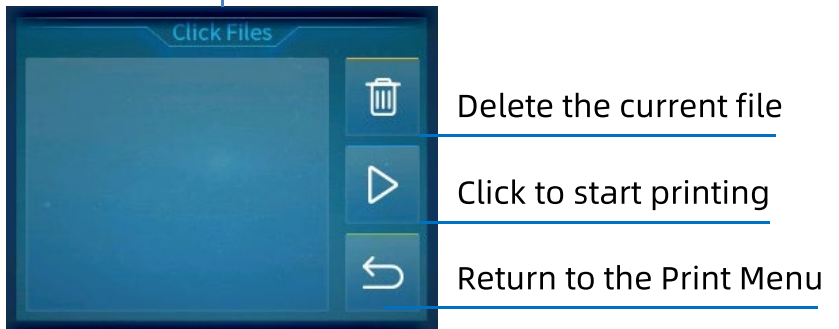

System

Language: Change language(English/Chinese)

Service:

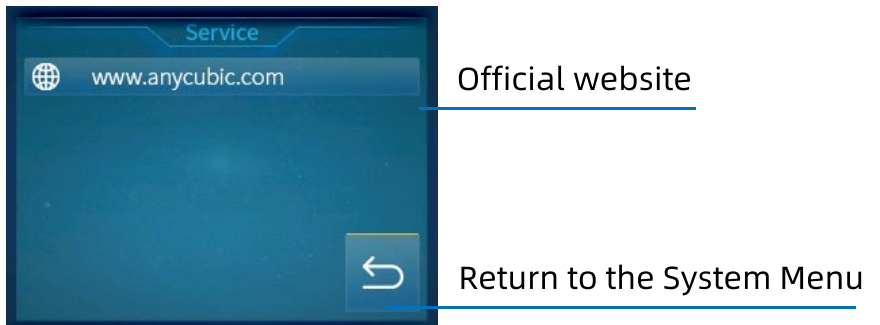

Information:

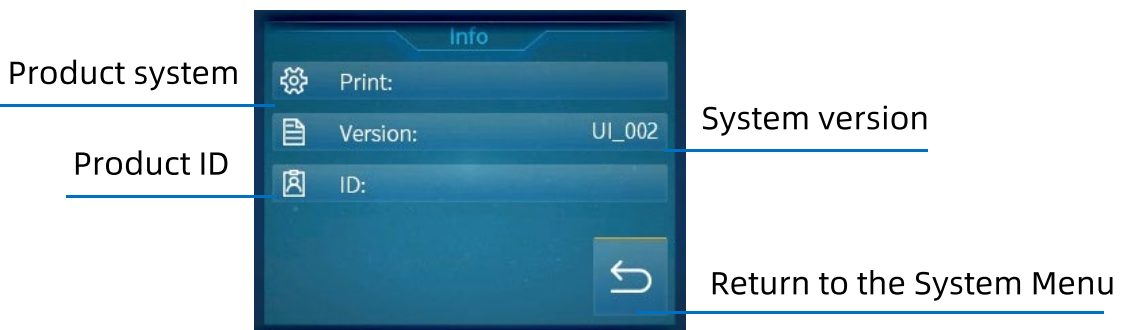

Menu Directory

Tools

Move Z:



The 'Move Z' menu interface includes the following elements:

- Buttons for '0.1mm', '1mm', and '10mm' to specify the distance to move.
- An upward arrow button to move the Z axis upwards.
- A downward arrow button to move the Z axis downwards.
- A house icon button to return to zero.
- A circle with a diagonal line button to stop moving the Z axis.
- A left arrow button to return to the Tools Menu.

Annotations for the 'Move Z' menu:

- Move Z by 0.1mm/1mm/10mm (points to the distance selection buttons)
- Return to Zero (points to the house icon button)
- Return to the Tools Menu (points to the left arrow button)
- Move the Z axis downwards (points to the downward arrow button)
- Move the Z axis upwards (points to the upward arrow button)
- Stop moving the Z axis (points to the circle with diagonal line button)

Detection:



The 'Detection' menu interface includes the following elements:

- Three image selection buttons to choose a detection image.
- An 'S' button to set the test time.
- An upward arrow button to increase the test time.
- A downward arrow button to reduce the test time.
- A 'Next' button to test DMD for the preset time.
- A left arrow button to return to the Tools Menu.

Annotations for the 'Detection' menu:

- Select one of the images to detect (points to the image selection buttons)
- Reduce the test time (points to the downward arrow button)
- Return to the Tools Menu (points to the left arrow button)
- Increase the test time (points to the upward arrow button)
- Click to set the test time (points to the 'S' button)
- Test DMD for the preset time (points to the 'Next' button)

Z=0: Reset the zero point

Focus: The function is for factory testing only

Horn icon: Turn on/off the screen sound

Assembly and Leveling Instructions

1. Unpack the machine and take out the accessories. Then plug in the power cord and turn on the printer.



2. Raise the Z axis to a certain height to ensure that the toughened glass will not be scratched when the printing platform is installed.

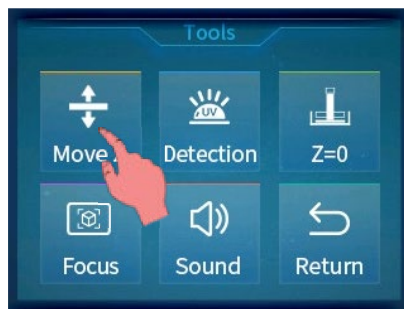

3. Remove the four screws on printing platform and then install the U-shape part with screws.

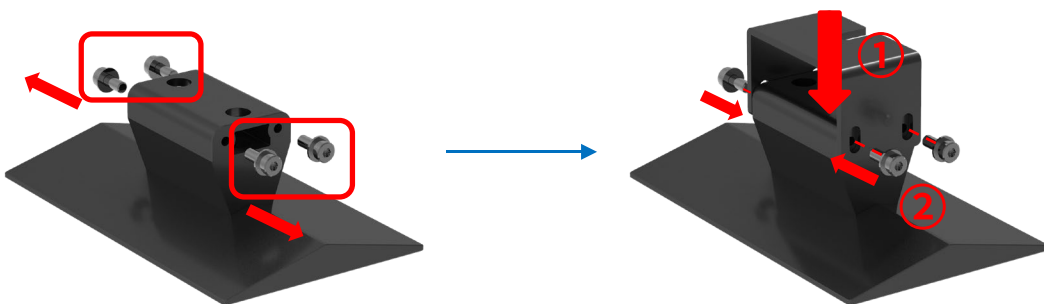

NOTE: Let the screws loose in this moment.

Assembly and Leveling Instructions

4. Install the printing platform.

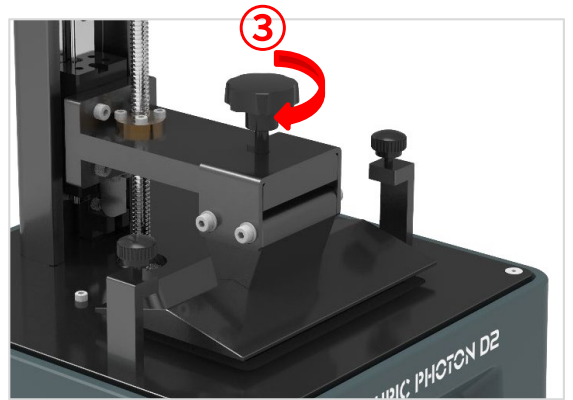
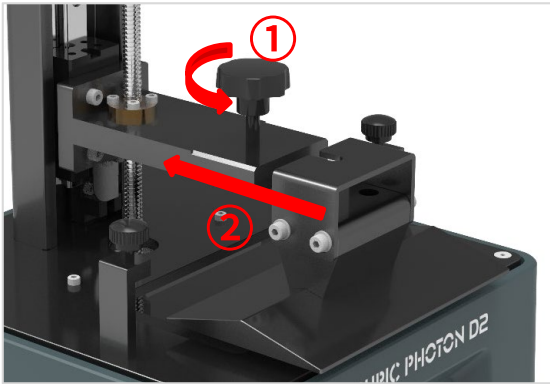

5. Place the leveling paper upon the toughened glass. Then click “  ” on the touch screen. Wait for the Z axis to descend and stop automatically.

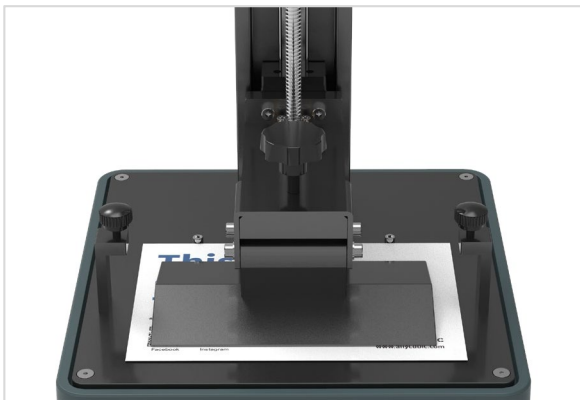

6. Use your fingers to press the platform to let it fit evenly on the toughened glass. Then tighten the four screws on the platform.



Assembly and Leveling Instructions

7. Return to "Tools" and click "Z=0" to save the zero position, and then click "Enter" on the pop-up window. Till now, the leveling process is finished. Click "Enter" again and take out the leveling paper.

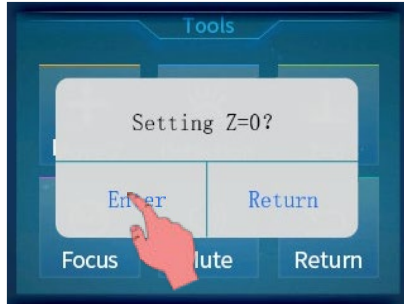

8. Detection: Raise printing platform until the toughened glass can be observed completely. Enter in "Tools"→"Detection". Select a image and set the test time, then click "Next". It should display a complete image as what you select.

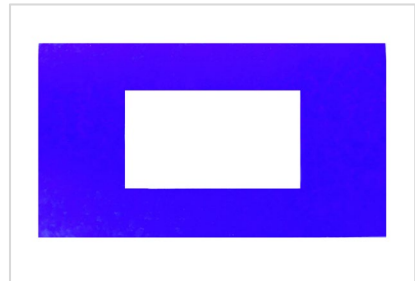
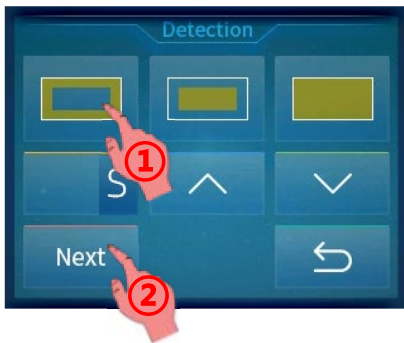

9. Install the resin vat.

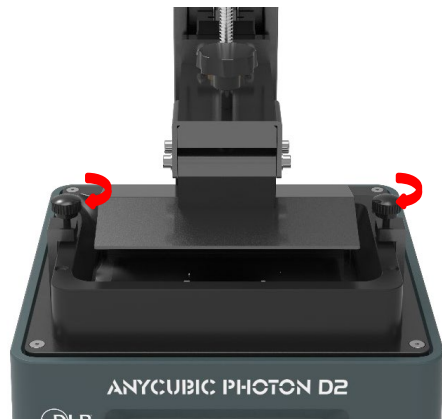
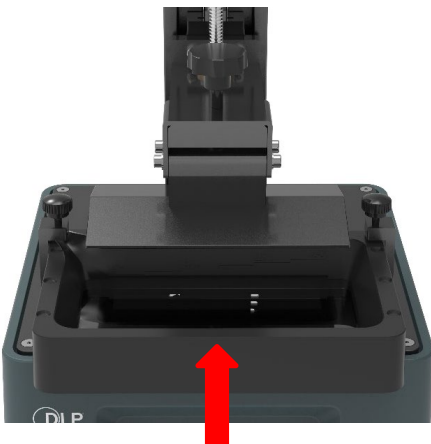

First Print Instructions

1. Print

*Please check FEP film carefully before and after every printing. If the FEP film is broken, replace it immediately to avoid further damage to machine.

Wear masks and gloves (to avoid direct skin contact with resin), and slowly pour the resin into the vat. The resin cannot exceed the vat's maximum scale. Then, put on the cover. Insert the USB memory into the USB port, print the test file in it. The print time on the screen is for reference only, we make no guarantee that it is the actual print time.

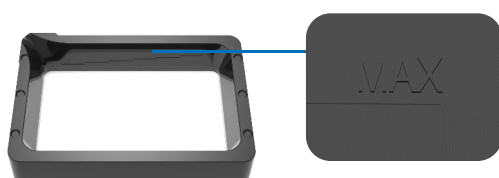

Do not exceed the maximum scale on the vat

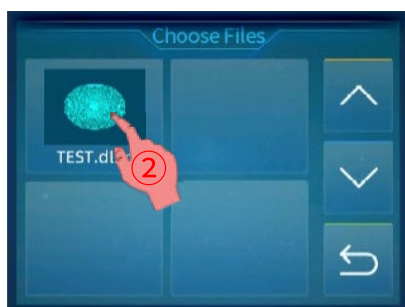

Notes:

- ① It is recommended that use the USB drive we provided. Otherwise, please use the USB drive whose memory size **not exceed 8G** and ensure that it is formatted to **FAT/FAT 32**.
- ② The print files should be placed at the root directory of USB drive to avoid read error.

If it is necessary, click "Pause" to pause the printing and wait for platform rising up. Then click "Start" to resume printing.

First Print Instructions



click to pause



click to start

2. Handling models and residues

After printing, unscrew and remove the platform when resin stop dropping from the platform. The model can be removed by scrapper. The removed model should be washed with ethanol 95vol% concentration. The printed object may need post curing to achieve better hardness by direct **sunlight** or UV-curing box.



【IMPORTANT】 Inevitably, in case of incomplete curing or failed prints, there might be some cured resin left in the vat. It is suggested to filter the resin by a funnel and then store the liquid in a sealed container. The residues left on the platform or in the vat can be wiped off with paper towel.

Before each prints, please ensure there is no solid residues in the vat or on the platform, otherwise the FEP film may be crushed and broken during printing.

Slicing Software Overview

3D printer reads sliced file and prints models. It is necessary to convert 3D files (stl./obj.) into sliced files for machine to recognize. Software that realize the process is called slicing software, for example, Anycubic Photon Workshop.

1. Anycubic Photon Workshop

Anycubic Photon Workshop can be used to export sliced file. You should select **Anycubic Photon D2** as machine type first, then manipulate the model and set the parameters. Lastly, export the sliced file (.dl2p).

The instruction of Anycubic Photon Workshop has been saved in the USB memory, it is recommended that read it carefully if it is the first time for you to use Anycubic Photon Workshop.

2. Advance

If you want to set different parameters of different stages of Z-axis movement, switch slice parameter to advance mode in settings.

- **Step [0]:** The stage when printing platform is moving near the curing face. The speed of this stage is relatively slow to avoid affecting the printing.
- **Step [1]:** The stage that printing platform is moving away from the curing face. The speed of this stage is relatively fast to shorten the printing time.

Slicing Software Overview

The following parameters are for reference.

Bottom Layers		
Step [0]	Z Lift Height(mm)	2
	Z Lift Speed(mm/s)	1
	Z Retract Speed(mm/s)	1.5
Step [1]	Z Lift Height(mm)	4
	Z Lift Speed(mm/s)	2
	Z Retract Speed(mm/s)	3
Transition Layer Count: 10		
Normal Layers		
Step [0]	Z Lift Height(mm)	2
	Z Lift Speed(mm/s)	1
	Z Retract Speed(mm/s)	1.5
Step [1]	Z Lift Height(mm)	3
	Z Lift Speed(mm/s)	2
	Z Retract Speed(mm/s)	3

TIPS: The instructions of advance mode is in Anycubic Photon Workshop User Manual.

FAQ and Machine Maintenance

1. FAQ

(1) Model do not stick to platform

- Bottom exposure time is insufficient, increase the time.
- Contact area between the model and platform is small, please add raft.
- Bad leveling.

(2) Layer separation or splitting

- The machine is not stable during printing.
- FEP film in the vat is not tight enough or needs to be replaced.
- The printing platform or resin vat is not tightened.
- The lift speed is too fast.
- The printing object is hollowed without punching.

(3) Layer shift

- Add supports.
- Reduce the lift speed.

(4) Floccules left in resin vat or attached to models

- Over exposure. Reduce the normal exposure time and bottom exposure time appropriately.

2. Machine maintenance



- (1) If Z axis make noisy sound, please apply lubricant to Z lead screw.

FAQ and Machine Maintenance



(2) Clean the residues cured on release film: Expose full screen for 20s and then remove the cured resin sheet to protect the film. **DO NOT use sharp objects to scrape off the residues on FEP film.**

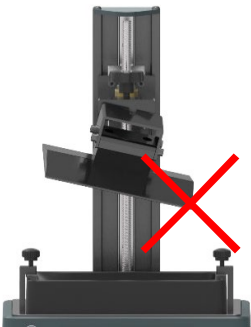

(3) Be careful when remove the platform, do not let it fall to damage the machine.

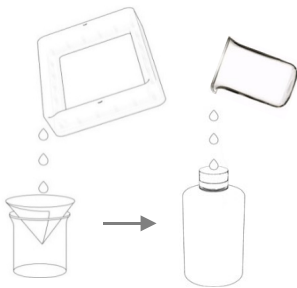

(4) Do not left resin in resin vat for over two days when it is unused. Please filter and store the resin properly.

(5) That fingerprint, dust or other stain on the glass may affect the detail of model, please clean the glass with clean kit.

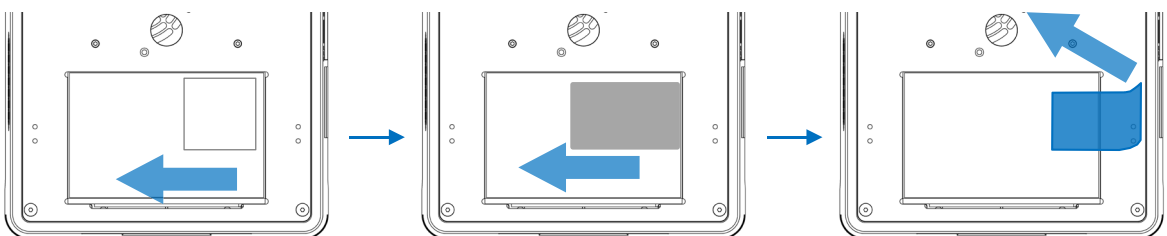

① alcohol prep pad

② dry wipe

③ dust-absorber

FAQ and Machine Maintenance

(6) After printing, please clean up the platform (**wipe with paper towels or wash with alcohol**), and ensure no residue left (**filter the residue with funnel**).

(7) If the body of printer is stained with resin, use alcohol to clean. If platform securing knob or vat retaining screw is stained with resin, please clean it timely to avoid loose of screw. Otherwise, it may cause print failure or even damage to the printer.

(8) If toughened glass is stained with resin, please clean up with paper towels or alcohol.

(9) If resin infiltrates into the sealant that cannot be cleaned, please expose to the sun until the resin is cured. Liquid resin infiltrating into inside of machine may cause malfunction.

(10) Please clean the resin vat first before you change resin.

(11) Do not use or place machine in the dusty environment for a long time to avoid the pollution of optical path.

(12) After use, turn off the machine first. Do not unplug the machine when it is working to avoid the damage of DMD.

(13) The machine should be moved carefully to avoid collision or severe vibration.

Thank you for purchasing **ANYCUBIC** products! Under normal usage and service, the products have a warranty period up to one year. Please visit **ANYCUBIC** support center(support.anycubic.com) to report any issue with **ANYCUBIC** products. Our professional after-sale service team would respond within 24 hours and solve the issues.