

MARSRIVA

USER MANUAL

LiFePO4 Battery

MR-LBP24-314-WMT

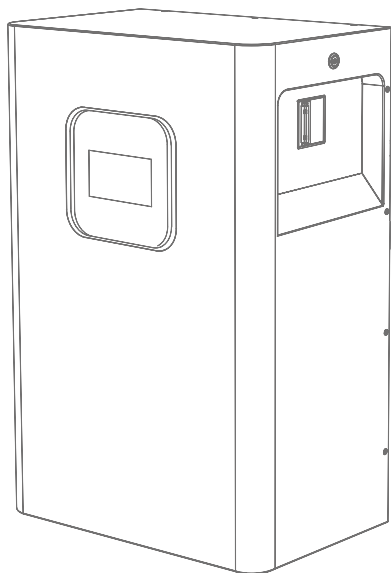

www.marsriva.com

Security Instructions

Please retain this manual for future reference. This manual contains instructions for the installation as well as operation of the Home Storage Battery Pack. Please read all instructions and precautions in the manual carefully before installation and use. There are non-safe voltages inside the home energy storage battery pack. To avoid personal injury, users should not disassemble it by themselves, and contact our professional maintenance personnel if maintenance is needed.

1. **Do not** put the battery into water or get it wet!
2. **Do not** charge the battery in a source of ignition or in extremely hot conditions!
Do not use or store batteries near sources of heat such as fire or heaters! If the battery leaks or emits an odor, remove it immediately from close proximity to an open flame;
3. Please use a dedicated charger!
4. **Do not** reverse the positive and negative terminals!
5. **Do not** connect the battery directly to a wall outlet or vehicle cigarette lighter outlet!
6. **Do not** put the battery into a fire or heat the battery!
7. It is prohibited to short-circuit the positive and negative terminals of the battery with wires or other metal objects, and it is prohibited to transport or store the battery together with necklaces, hairpins or other metal objects!
8. **Do not** pierce the battery case with nails or other sharp objects, and do not hammer or foot the battery!
9. **Do not** hit, throw or subject the battery to mechanical shocks!
10. Direct soldering of battery terminals is prohibited!
11. It is prohibited to disassemble the battery in any way!
12. It is prohibited to place the battery in a microwave oven or pressure vessel!
13. Prohibit the use of batteries in combination with primary batteries (e.g. dry cell batteries) or batteries of different capacities, models and varieties!
14. **Do not** use the battery if it emits a strange odor, heat, deformation, discoloration or any other abnormal phenomenon; if the battery is in use or charging, it should be immediately removed from the appliance or charger and stop using it!

Product Packaging

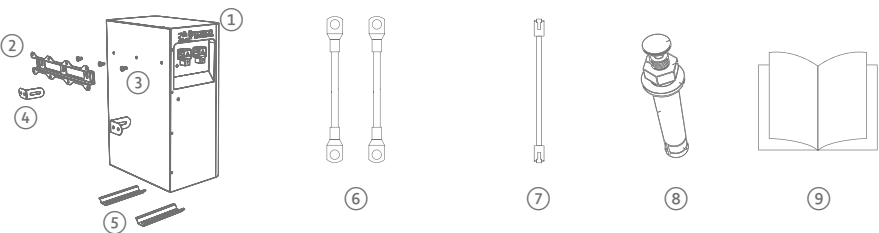

- ① LiFePO4 Battery Product × 1
- ② Wall-Mount Bracket × 1
- ③ Wall-Mount Bracket Screws × 3
- ④ L-Shaped Wall Bracket × 2
(With M6 Screws × 2)
- ⑤ Bottom Support Bracket × 2
(With M4 Screws × 8)
- ⑥ Battery Connection Cables Kit × 1
- ⑦ BMS Communication Cable × 1
- ⑧ Expansion Screws × 8
- ⑨ User Manual × 1

Specification

Model	MR-LBP24-314-WMT
Battery Model	LiFePO4 Battery (Grade A)
Nominal Energy	8.03kWh
Nominal Operating Voltage	25.6V
Battery Capacity	314Ah
Battery Internal Resistance	≤10mΩ
Charge Current	210A (Max.)
Charge Overcurrent Protection	215A
Discharge Current	210A (Max.)
Discharge Overcurrent Protection	215A
Overcharge Protection	29.2V
Overcharge Protection Recovery	27.0V
Overdischarge Protection	21.6V
Overdischarge Protection Recovery (within 30 seconds)	24V
Charge High Temperature Protection	55°C
Charge High Temperature Protection Recovery	50°C
Charge Low Temperature Protection	0°C
Charge Low Temperature Protection Recovery	5°C
Discharge High Temperature Protection	55°C
Discharge High Temperature Protection Recovery	50°C
Discharge Low Temperature Protection	-20°C
Discharge Low Temperature Protection Recovery	-15°C
Short Circuit Protection	Turn-off the unit and remove device connection, then restart after 2 min
Storage Temperature	-30°C to 35°C
Battery Equalization	Passive Equalization
Power Off Self-Consumption	≤300uA
Battery Cycle Life	≥6000 cycles @25°C, to 70% EOL
Communication Ports	BMS (485 / CAN), RS232, Parallel
Dimensions (W×D×H)	398 × 238 × 600mm
Weights	69kg

Function Introduction

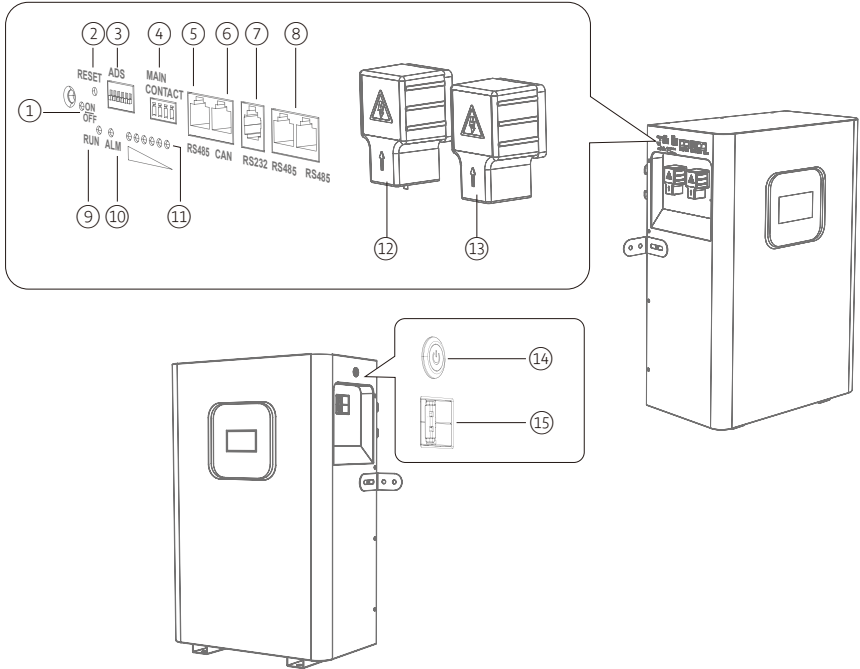

Number	Functionality	Description
①	Power Indicator	Display ON / OFF Status
②	Reset Switch	Reboot or shutdown when pressed
③	DIP Address	Address selection for parallel communication
④	Dry Contact	Normally open or normally closed signal drive relay
⑤	RS485	For BMS communication
⑥	CAN	For BMS communication
⑦	RS232	For PC communication
⑧	RS485, RS485	For parallel communication and PC
⑨	Operation Indicator	Display working status
⑩	Alarm Indicator	Alerts
⑪	Battery Indicator	Display remaining capacity
⑫	Positive terminal	Positive battery terminal
⑬	Negative terminal	Negative battery terminal
⑭	Power Switch	Control power ON / OFF
⑮	Air Switch	Disconnect input and output

Description of the Color Touch Screen

1. Starting Screen



2. Main Screen

The main page displays parallel statistics such as average SOC, maximum and minimum battery voltage, maximum and minimum battery temperature, average battery voltage and total system current, average remaining system power, operating power, MOS charging and discharging status, and language switching functions.



3. Language

The system supports switching between English and Chinese, and the switching button is located at the top right corner of the homepage.

4. Slave Device

After switching to the Slave Device page, the upper part displays the version selection, the middle part visualizes the battery level and SOH data, the middle part displays the battery voltage and current, the charge/discharge status and the fault indication status, and the lower part displays the battery level and temperature data of the Slave Device as well as the ambient temperature and MOS temperature data.

Background color description of the slave address: blue indicates the selected slave controller, green indicates the online slave controller, and white indicates the offline slave controller.



5. Users Login

Password-666888



6. Parameter Setting

In the parameter setting page, you can set the battery overcharge and over-discharge protection voltage parameters, ambient high-temperature and low-temperature parameter, voltage differential parameter charging, over-current parameter, discharging over-current parameter, MOS high-temperature parameter, charging high temperature and low-temperature parameter, discharging high temperature and low-temperature parameter, and SOC high-temperature parameter.

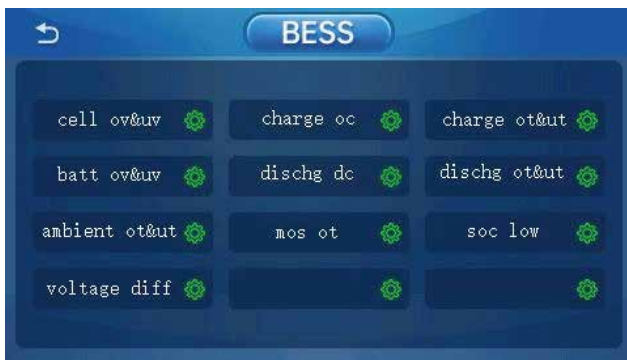

7. Protocol Setting

Optional CAN protocols: Pylon, Growatt, Goodwe, Sofarsolar, Victron, Voltronic, Lxp, Deye, Ginlong, Sma.

Optional RS485 protocols: Pylon, Growatt, Voltronic, Lxp, Deye, Invent, Srne.



8. System Setting



Installation instructions

1. Unpacking and Inspection

Inspect the unit before installation. Make sure there is no damage in the package. You should receive the following items in the package:

- ① LiFePO4 Battery Product × 1
- ② Wall-Mount Bracket × 1
- ③ Wall-Mount Bracket Screws × 3
- ④ L-Shaped Wall Bracket × 2
(With M6 Screws × 2)
- ⑤ Bottom Support Bracket × 2
(With M4 Screws × 8)
- ⑥ Battery Connection Cables Kit × 1
- ⑦ BMS Communication Cable × 1
- ⑧ Expansion Screws × 8
- ⑨ User Manual × 1

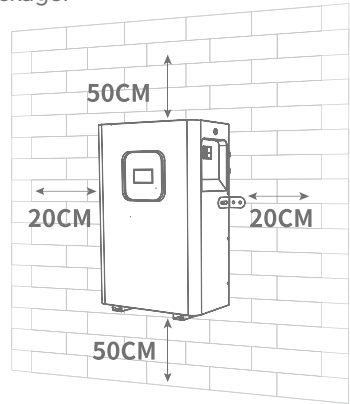

2. Preparation (Installation With Power Off)

Before selecting a mounting location, consider the following:

- ① Do not install the battery pack on flammable building materials.
- ② Mount on a sturdy surface.
- ③ Mount the battery pack at eye level so that the LCD display can be read at all times.
- ④ Ambient temperature should be between 0°C and 55°C to ensure optimal operation.
- ⑤ Vertical mounting on a wall is recommended.
- ⑥ Be sure to leave other objects and surfaces as shown on the above to ensure adequate heat dissipation and enough room to remove wires.
- ⑦ Before connecting all wiring, remove the bottom cover by unscrewing the two screws.

Note: Suitable for installation on concrete or other non-flammable surfaces only.

3. Installation of Equipment

- ① Use expansion screws to fix the bracket on the wall again first.
- ② Short screws to fix the bracket on the back case of the machine and then hang it on the wall.

LED Display Description

Table 1 LED display description

State of system	Event	ON/OFF (LED9)	RUN (LED8)	ALARM (LED7)	SOC (LED6~1)						Instruction	
					LED6	LED5	LED4	LED3	LED2	LED1		
					●	●	●	●	●	●		
Power Off	Sleep	OFF	OFF	OFF	OFF	OFF	OFF	OFF	OFF	OFF	All LEDs turn off	
Static State	Normal	ON	Flash 1	OFF	Refer to table 2						/	
	Alarm	ON	Flash 1	Flash 3							/	
Charging	Normal	OFF	OFF	OFF							/	
	Alarm	ON	ON	Flash 3							The over-voltage alarm does not flash	
	OV Protect	ON	ON	OFF	ON	ON	ON	ON	ON	ON	/	
	Temperature, Over-current, fail-safe.	ON	OFF	ON	OFF	OFF	OFF	OFF	OFF	OFF	/	
Discharging	Normal	ON	Flash3	OFF	Refer to table 2						/	
	Alarm	ON	Flash3	Flash3							/	
	UV Protect	OFF	Flash2	OFF	OFF	OFF	OFF	OFF	OFF	OFF	OFF	/
	Over-current short circuit, temperature, fail-safe	ON	OFF	ON	OFF	OFF	OFF	OFF	OFF	OFF	OFF	/

Table 2 SOC display description

State	Charging						Discharging						
	LED6	LED5	LED4	LED3	LED2	LED1	LED6	LED5	LED4	LED3	LED2	LED1	
	●	●	●	●	●	●	●	●	●	●	●	●	
SOC%	0 – 16.6%	OFF	OFF	OFF	OFF	OFF	Flash2	OFF	OFF	OFF	OFF	OFF	ON
	16.6 – 33.2%	OFF	OFF	OFF	OFF	Flash2	ON	OFF	OFF	OFF	OFF	ON	ON
	33.2 – 49.8%	OFF	OFF	OFF	Flash2	ON	ON	OFF	OFF	OFF	ON	ON	ON
	49.8 – 66.4%	OFF	OFF	Flash2	ON	ON	ON	OFF	OFF	ON	ON	ON	ON
	66.4 – 83.0%	OFF	Flash2	ON	ON	ON	ON	OFF	ON	ON	ON	ON	ON
	83.0 – 100%	Flash2	ON	ON	ON	ON	ON	ON	ON	ON	ON	ON	ON
RUM LED ●	ON						Flash3						

Table 3 LED flash description

Flash Mode	ON	OFF
Flash1	0.25S	3.75S
Flash2	0.5S	0.5S
Flash3	0.5S	1.5S

Buzzer Action Description

- ① When a fault occurs, buzzer beeps 0.25s every 1s;
- ② When protecting, buzzer beeps 0.25s every 2s (except over/under voltage protection);
- ③ When an alarm is generated, buzzer beeps 0.25s every 3s (except for over-voltage or under-voltage alarm).

Reset Key Switch Description

- ① When the BMS is in sleep state, press the key (1s and release it, the protection board is activated, and the LED indicator lights up successively from "LED1" for 0.5s.
- ② When the BMS is active, press the button (3s to 6s), and the LED indicator will turn on for 0.5 seconds from the lowest power indicator. When released, the system will go to sleep.
- ③ When the BMS is in the active state, press the button (6s-10s) and release it, the protection board is reset, and the LED indicator is displayed according to the current power.

Notice: Make sure the battery is not charging or discharging before using the reset switch! Otherwise there is a risk of battery failure.

Description of Power Button

- ① When the BMS is in off state, after pressing power button, the BMS board is powered on, and the LED indicator lights up successively from "LED1" for 0.5s.
- ② When the BMS is active, turn off the power button and wait for 1s~3s before the system enters the power-off state.

Communication Interface

Interface illustration:

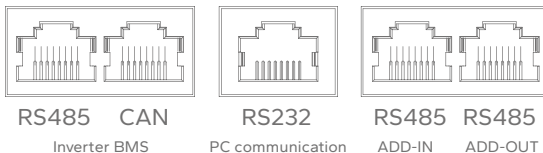

Interface Definition:

Interfaces	RS485		CAN		RS232		RS485	
Functional description	Connection to host computer or inverter		Connection to host computer or inverter		Parallel communication		Parallel communication	
Pin descriptions	PIN	Description	PIN	Description	PIN	Description	PIN	Description
	1, 8	RS485-B1	1, 8	NC	1, 2, 6	NC	1, 8	RS485-B2
	2, 7	RS485-A1	2, 7	NC	3	TX	2, 7	RS485-A2
	4	NC	4	CAN H	4	RX	4	NC
	5	NC	5	CAN L	5	GND	5	NC(L)/OUT(R)
	3, 6	GND	3, 6	GND			3, 6	GND

Dip Switch

When packs are connected in parallel, use the DIP address function when DIP 6 is connected to ON. Otherwise, use the default automatic addressing function. Use the DIP switch on the BMS to set the address to distinguish different packs.

Product can use in parallel up to 15 units.

Notice: Up is 1 & ON, Down is 0 & OFF.

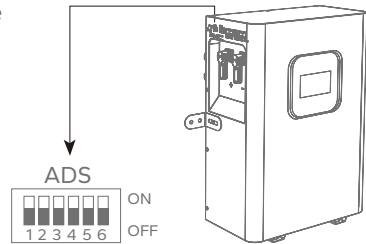

Address bit (binary)					Explain
	1	2	3	4	
0001 (1)	ON	OFF	OFF	OFF	Set PACK1 to be used by a host or single machine
0010 (2)	OFF	ON	OFF	OFF	Set PACK2
0011 (3)	ON	ON	OFF	OFF	Set PACK3
0100 (4)	OFF	OFF	ON	OFF	Set PACK4
0101 (5)	ON	OFF	ON	OFF	Set PACK5
0110 (6)	OFF	ON	ON	OFF	Set PACK6
0111 (7)	ON	ON	ON	OFF	Set PACK7
1000 (8)	OFF	OFF	OFF	ON	Set PACK8
1001 (9)	ON	OFF	OFF	ON	Set PACK9
1010 (10)	OFF	ON	OFF	ON	Set PACK10
1011 (11)	ON	ON	OFF	ON	Set PACK11
1100 (12)	OFF	OFF	ON	ON	Set PACK12
1101 (13)	ON	OFF	ON	ON	Set PACK13
1110 (14)	OFF	ON	ON	ON	Set PACK14
1111 (15)	ON	ON	ON	ON	Set PACK15

Parallel Wiring Instruction

Interface illustration:

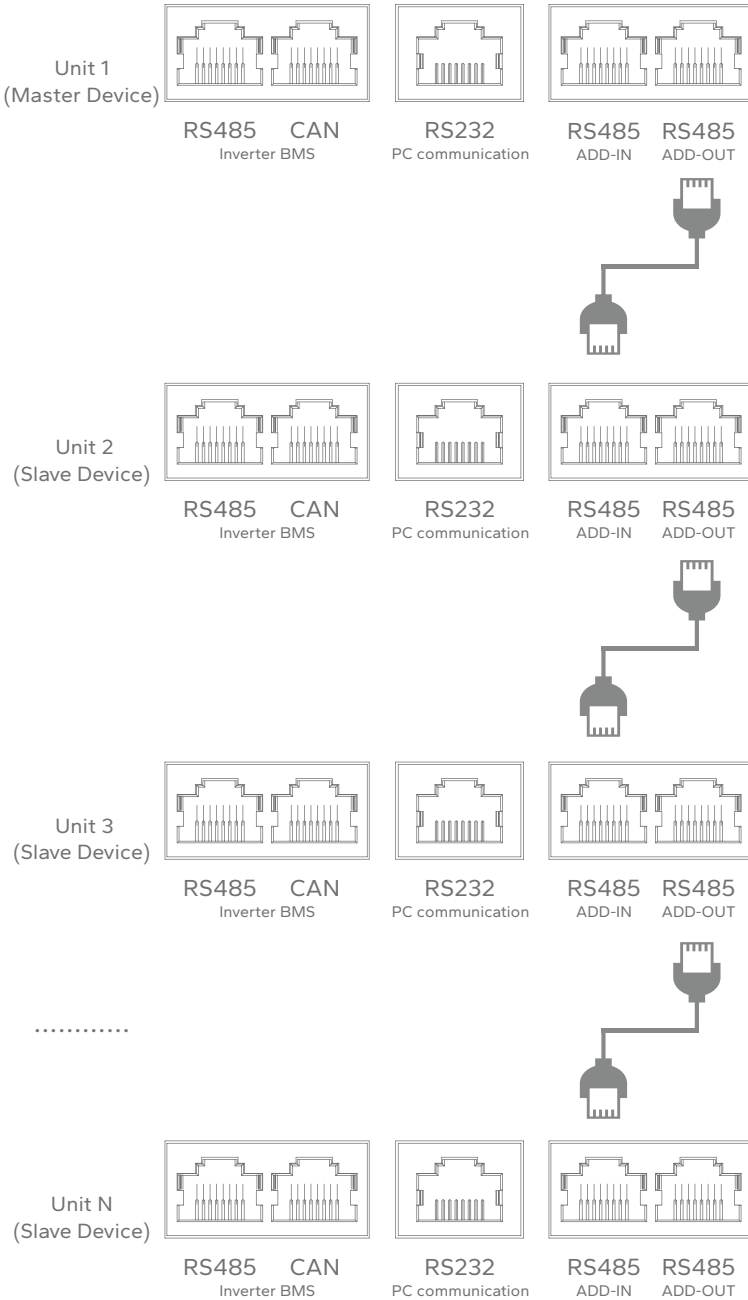

Warranty Description

Please read the instructions carefully and keep them in a safe place,

- ① We are responsible for this product and repair it if it malfunctions during the warranty period.
- ② For replacement or warranty, please send this warranty card together with the product.
- ③ No free repairs will be made during the warranty period if any of the following conditions apply.
 - Damage caused by failure to comply with the requirements of the instruction manual for use, maintenance and repair, or the use of non-original parts.
 - Failure or damage caused by improper storage and custody (product battery failure due to not recharging the product for a long period of time).
 - Failure or damage caused by the use of power supply equipment and load rated equipment not within the specified voltage range.
 - Failure or damage caused by private repair, dismantling or modification.
 - Damage to the surface coating and exterior is not covered by the warranty.
 - Product outer packaging and product accessories are not covered by the warranty.
 - Torn, altered or unrecognizable product labels, seals and serial numbers (SN).
- ④ Failure or damage due to force majeure (force majeure refers to an objective event that cannot be foreseen, avoided or overcome. This includes natural disasters such as floods, fires, explosions, lightning, earthquakes and storms, as well as social events such as wars and disturbances).
- ⑤ This manual is for use only in (this sales area), the final interpretation right belongs to the company. Please keep this manual in a safe place as it will not be distributed separately to users.
- ⑥ If the name of the distributor is not written or stamped, ask the distributor from whom you purchased the product for proof of the date of purchase and the name of the distributor, and issue a receipt to the distributor. If you do not have such proof, please contact your dealer or the company from which you purchased the product. If you purchased the product from our online store, please be sure to provide proof of the date of purchase, such as an invoice, order number, or a screen shot of your order history.

Reimbursable Service Warranty

Because the product does not meet the warranty conditions need to be charged, the company will be based on parts and labor costs to calculate the appropriate repair costs and put forward a repair quote to you, after obtaining your consent and payment of the cost to provide repair services for your product.

Thank you for purchasing Marsriva product

PRODUCT WARRANTY CARD

Product :

Model :

Purchase Date (DD / MM / YY) :

Customer Name :

Telephone Number :

E-mail Address :

Dealer's Name and Address :

Serial Number :



This Warranty applies only if the Product was newly manufactured on the Date of Purchase and not sold as used, refurbished, or manufacturing seconds. Please keep the proof of purchase and this warranty card for future service requests.

IMPORTANT!

Please store this card in a secured location for future reference.

Marsriva reserves the right to request this card before accepting repair requests.

This does not affect or limit your mandatory statutory rights.

MARSRIVA Technology Co., Ltd.

Website: www.marsriva.com

E-mail: support@marsriva.com

Made in China

CE FC RoHS



Specifications are subject to change without notice, all product drawings are for reference only.