

SHARP

COMMERCIAL MICROWAVE OVEN

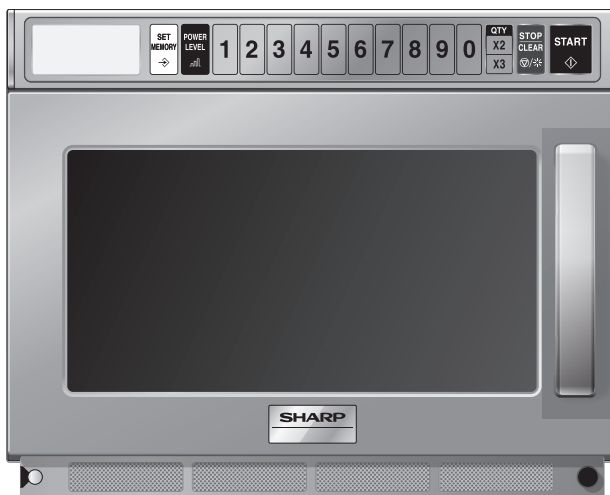

EN

Original Instruction

OPERATION MANUAL - This operation manual contains important information which you should read carefully before using your microwave oven.

IMPORTANT:

There may be a serious risk to health if this operation manual is not followed or if the oven is modified so that it operates with the door open.

YB-S6192AE 1800W (IEC 60705)

CONTENTS

IMPORTANT SAFETY INSTRUCTIONS	EN-2	MANUAL OPERATION	EN-10
INSTALLATION INSTRUCTIONS	EN-5	MANUAL COOKING	EN-10
PART NAMES	EN-6	OTHER CONVENIENT FEATURES	EN-11
ACCESSORIES	EN-6	PROGRAM LOCK SETTING	EN-11
SHORT DESCRIPTION OF FEATURES	EN-7	OVEN LAMP SETTING	EN-12
BEFORE OPERATION	EN-7	AUDIBLE SIGNAL SOUND SETTING	EN-13
HOW TO OPERATE THE OVEN	EN-7	COUNTER CHECK/CLEAR	EN-14
MEMORY OPERATION	EN-7	CARE AND CLEANING	EN-15
MEMORY COOKING	EN-7	SERVICE CALL CHECK	EN-16
COOKING DOUBLE/TRIPLE QUANTITY		GUIDE	EN-17
WITH MEMORY	EN-8	SPECIFICATIONS	EN-18
SAVING MEMORIES	EN-8		
MEMORY CHECK	EN-9		



Information on the Disposal of this Equipment

IF YOU WISH TO DISPOSE OF THIS EQUIPMENT, DO NOT USE THE ORDINARY WASTE BIN, AND DO NOT PUT THEM INTO A FIREPLACE!

Used electrical and electronic equipment should always be collected and treated SEPARATELY in accordance with local law.

Separate collection promotes an environment-friendly treatment, recycling of materials, and minimizing final disposal of waste. IMPROPER DISPOSAL can be harmful to human health and the environment due to certain substances! Take USED EQUIPMENT to a local, usually municipal, collection facility, where available.

If in doubt about disposal, contact your local authorities or dealer and ask for the correct method of disposal.

ONLY FOR USERS IN THE EUROPEAN UNION, AND SOME OTHER COUNTRIES; FOR INSTANCE NORWAY AND SWITZERLAND: Your participation in separate collection is requested by law.

The symbol shown above appears on electrical and electronic equipment (or the packaging) to remind the users of this.

Users from PRIVATE HOUSEHOLDS are requested to use existing return facilities for used equipment. Return is free of charge.

If the equipment has been used for BUSINESS PURPOSES, please contact your SHARP dealer who will inform you about take-back. You might be charged for the costs arising from take-back. Small equipment (and small quantities) might be taken back by your local collection facility. For Spain: Please contact the established collection system or your local authority for take-back of your used products.



[www.sharpconsumer.com/
documents-of-conformity/](http://www.sharpconsumer.com/documents-of-conformity/)

Declarations of conformity are available from www.sharpconsumer.com/documents-of-conformity/

IMPORTANT SAFETY INSTRUCTIONS

IMPORTANT SAFETY INSTRUCTIONS: READ CAREFULLY AND KEEP FOR FUTURE REFERENCE

1. This appliance is intended to be used by foods entree professionals or trained users for commercial use.
2. This oven is designed to be used on a countertop only. It is not designed to be built into a kitchen unit. Do not place the oven in a cabinet.
3. The electrical outlet must be readily accessible so that the unit can be unplugged easily in an emergency.
If smoke or burning is observed: Keep the oven door closed and switch off the power by disconnecting the plug from the socket in order to stifle any flames. Failure to follow this procedure may result in fire and oven damage.
4. Ensure there is a minimum of free space above the oven of 10 cm.
5. This appliance can be used by children aged from 8 years and above and persons with reduced physical, sensory or mental capabilities or lack of experience and knowledge if they have been given supervision or instruction concerning use of the appliance in a safe way and understand the hazards involved.
6. Children shall not play with the appliance. Cleaning and user maintenance shall not be made by children without supervision.
7. **WARNING:** If the door or door seals are damaged, the oven must not be operated until it has been repaired by a competent person.
8. **WARNING:** Never adjust, repair or modify the oven yourself. It is hazardous for anyone other than a competent person to carry out any service or repair operation which involves the removal of a cover which gives protection against exposure to microwave energy.
9. If the power supply cord of this appliance is damaged, it must be replaced by an authorised SHARP service agent in order to avoid a hazard.
- 10 **WARNING:** Liquids and other foods must not be heated in sealed containers since they are liable to explode.
11. **WARNING:** Microwave heating of beverages can result in delayed eruptive boiling, therefore care must be taken when handling the container.
12. Do not cook eggs in their shells, and whole hard boiled eggs should not be heated in microwave ovens since they may explode even after microwave cooking has ended. To cook or reheat eggs which have not been scrambled or mixed, pierce the yolks and the whites, or the eggs may explode. Shell and slice hard boiled eggs before reheating them in the microwave oven.
13. Utensils should be checked to ensure that they are suitable for use in the oven. See "GUIDE" on page EN-17. Use only microwave safe containers and utensils.
14. **WARNING:** The contents of feeding bottles and baby food jars must be stirred or shaken and the temperature checked before consumption, in order to avoid burns.
15. When heating food in plastic or paper containers, keep an eye on the oven due to the possibility of ignition.
16. Clean the oven at regular intervals and remove any food deposits.
17. Failure to maintain the oven in a clean condition could lead to deterioration of the surface that could adversely affect the life of the appliance and possibly result in a hazardous situation.
18. See instructions for cleaning door seals, cavities and adjacent parts on page EN-15.
19. The oven should not be cleaned with a water jet.

To avoid the danger of fire

1. **The microwave ovens should not be left unattended during operation. Power levels that are too high or cooking times that are too long may overheat foods resulting in a fire.**
2. The AC power supply must be 230V, 50Hz, with a minimum 16A distribution line fuse, or a minimum 16A distribution circuit breaker. In using two ovens, each oven must be secured with a 16A distribution line fuse or a distribution circuit breaker.
3. A separate circuit serving only this appliance should be provided.
4. Do not place the oven in areas where heat is generated. For example, close to a conventional oven.
5. Do not install the oven in an area of high humidity or where moisture may collect.
6. Do not store or use the oven outdoors.
7. **Clean the splash cover and the oven cavity after use. These must be dry and free from grease. Built-up grease may overheat and begin to smoke or catch fire.**
8. Do not place flammable materials near the oven or ventilation openings.
9. Do not block the ventilation openings.
10. Remove all metallic seals, wire twists, etc., from food and food packages. Arcing on metallic surfaces may cause a fire.
11. Do not use the microwave oven to fry with oil or heat oil for deep frying. The temperature can not be controlled and the oil catch fire.
12. To make popcorn, use only special microwave makers.
13. Do not store food or any other items inside the oven.
14. Check the settings after you start the oven to ensure the oven is operating as desired.
15. To avoid overheating and fire, special care must be taken when cooking or reheating foods with a high sugar or fat content, for example, Sausage rolls, Pies or Christmas pudding.
16. See the corresponding hints in this operation manual.

To avoid the possibility of injury

WARNING:

1. Do not operate the oven if it is damaged or malfunctioning. Check the following before use:
 - a) The door; make sure the door closes properly and ensure it is not misaligned or warped.
 - b) The hinges and safety door latches; check to make sure they are not broken or loose.
 - c) The door seals and sealing surfaces; ensure that they have not been damaged.
 - d) Inside the oven cavity or on the door; make sure there are no dents.
 - e) The power supply cord and plug; ensure that they are not damaged.
2. Do not operate the oven with the door open or alter the safety door latches in any way.
3. Do not operate the oven if there is an object between the door seals and sealing surfaces.
4. Do not allow grease or dirt to build up on the door seals and adjacent parts. Follow instructions for "Care and Cleaning", Page EN-15.
5. Individuals with PACEMAKERS should check with their doctor or the manufacturer of the pacemaker for precautions regarding microwave ovens.

To avoid the possibility of electric shock

1. Under no circumstances should you remove the outer cabinet.
2. Never spill or insert any objects into the door lock openings or ventilation openings. In the event of a spill, turn off and unplug the oven immediately, and call a SHARP service agent.
3. Do not immerse the power supply cord or plug in water or any other liquid.
4. Do not let the power supply cord hang over the edge of a table or work surfaces.
5. Keep the power supply cord away from heated surfaces, particularly the back of the oven.
6. Do not attempt to replace the oven lamp yourself or allow anyone who is not an electrician authorised by SHARP to do so. If the oven lamp fails, please consult your dealer or an authorised SHARP service agent.

To avoid the possibility of explosion and sudden boiling

1. Never use sealed containers. Remove seals and lids before use. Sealed containers can explode due to a build up of pressure even after the oven has been turned off.
2. Take care when microwaving liquids. Use a widemouthed container to allow bubbles to escape.

Never heat liquids in narrow necked containers such as baby bottles, as this may result in the contents erupting from the container when heated and cause burns.

To prevent sudden eruption of boiling liquid and possible scalding:

1. Do not use excessive amount of time.
 2. Stir liquid prior to heating/reheating.
 3. It is advisable to insert a glass rod or similar utensil (not metal) into the liquid whilst reheating.
 4. Let liquid stand for at least 20 seconds in the oven at the end of cooking time to prevent delayed eruptive boiling.
3. Pierce the skin on such foods as potatoes, sausages and fruit before cooking, or they may explode.

To avoid the possibility of burns

1. **Use pot holders or oven gloves when removing food from the oven to prevent burns.**
2. Always open containers, popcorn makers, oven cooking bags, etc., away from the face and hands to avoid steam burns and eruption of boiling.
3. **To avoid burns, always test food temperature and stir before serving and pay special attention to the temperature of food and drink given to babies, children or the elderly.**

Temperature of the container is not a true indication of the temperature of the food or drink; always check the food temperature.

4. Always stand back from the oven door when opening it to avoid burns from escaping steam and heat.
5. Slice stuffed baked foods after heating to release steam and avoid burns.
6. Keep children away from the door to prevent them burning themselves.
7. Do not touch the back of the oven because it will become hot.

To avoid misuse by children

1. Do not lean or swing on the oven door. Do not play with the oven or use it as a toy.

Other warnings

1. Never modify the oven in any way.
2. Do not move the oven while it is in operation.
3. This oven is for food preparation only and may only be used for cooking food. It is not suitable for laboratory use.

To promote trouble free use of your oven and avoid damage.

1. Never operate the oven when it is empty. Doing so may damage the oven.
2. When using a browning dish or self-heating material, always place a heat-resistant insulator such as a porcelain plate under it to prevent damage to the ceramic floor due to heat stress. The preheating time specified in the dishes instructions must not be exceeded.
3. Do not use metal utensils, which reflect microwaves and may cause electrical arcing. Do not put cans in the oven.
4. Do not place anything on the outer cabinet during operation.
5. Do not use the oven near a steamer or a fryer.

NOTE

1. If you are unsure how to connect your oven, please consult an authorized qualified electrician.
2. Neither the manufacturer nor the dealer can accept any liability for damage to the oven or personal injury resulting from failure to observe the correct electrical connection procedure.
3. Water vapour or drops may occasionally form on the oven walls or around the door seals and sealing surfaces. This is a normal occurrence and is not an indication of microwave leakage or a malfunction.

INSTALLATION INSTRUCTIONS

WARNING: Always keep the caution sheet (SPECIAL INSTRUCTIONS AND WARNINGS) close to the oven for your reference.

- 1) Remove all packing materials from the inside of the oven cavity. Remove all the blue protective film from the outside of the oven.
- 2) Check the oven carefully for any signs of damage.
- 3) Place the oven on a flat, level surface strong enough to support the oven's weight plus the heaviest item likely to be cooked.

Do not place this oven in a position which is not easily accessible. To position the oven too high can be dangerous because food can not be removed safely.

- 4) Ensure there is a minimum free space to install the oven. See the figure A.

Figure A

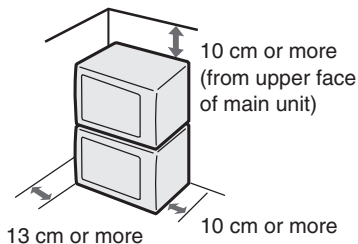

- 5) Securely connect the plug of the oven to a standard earthed (grounded) household electrical outlet.
- 6) Two same oven models can be installed together by placing one on top of another. Follow these instructions.
 - A. Place oven A in the desired location. Position Oven B on top of Oven A as shown in the figure B.
 - B. Remove Screws (a) and Mounting plates A and B.
 - C. Replace Screw (a) of Mounting plate A removed at step B and tighten it.
 - D. Remove Screws (b) and (c), then install Mounting plate A and B which were removed at step B to the each lower edge of Oven B as shown in the figure B.

NOTE: Turn over the Mounting plates when installing.

 - E. Replace Screws (b) and (c) which were removed at step D and tighten them.
 - F. Replace Screw (a) of Mounting plate B removed at

Figure B

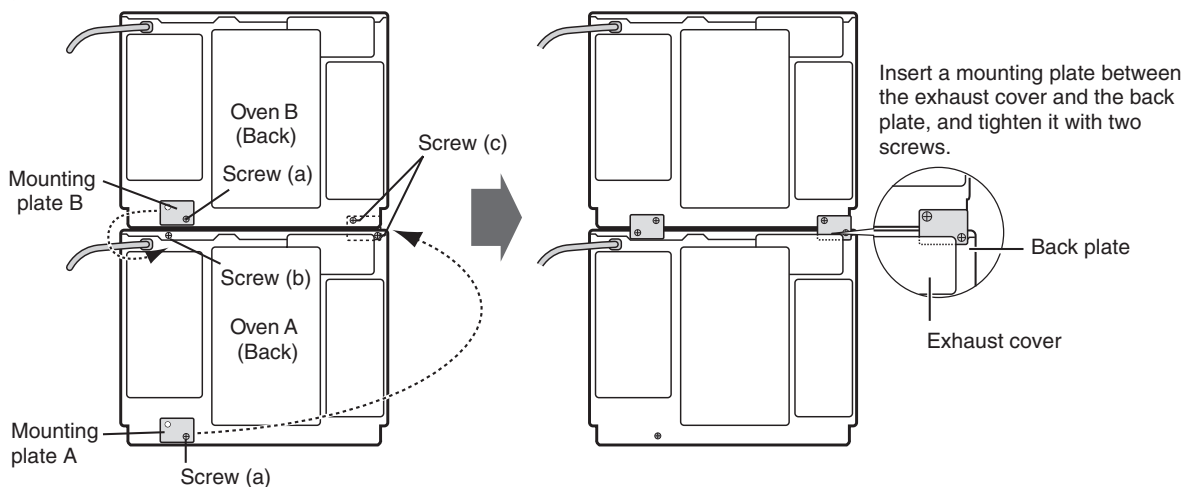

PART NAMES

OVEN

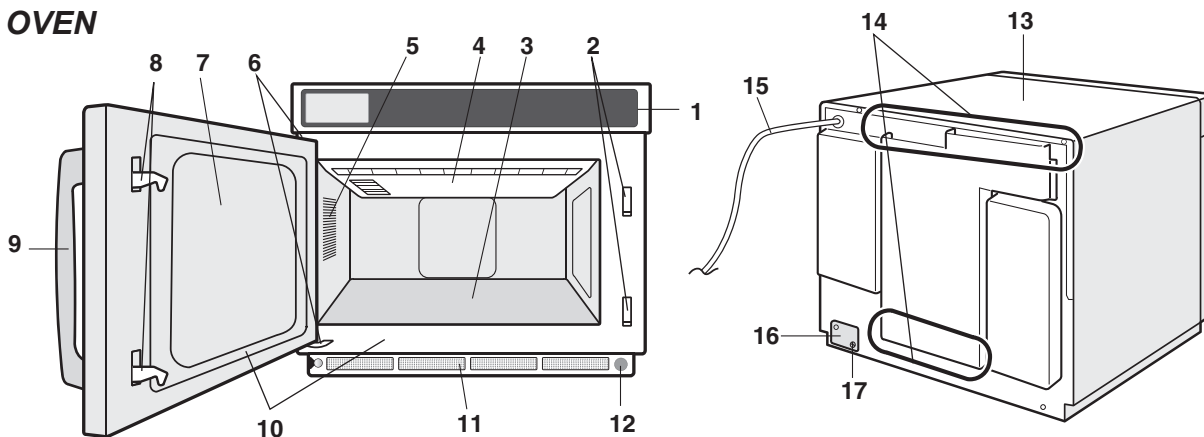

- | | |
|---|---|
| <ol style="list-style-type: none"> 1. Control panel 2. Door latch openings 3. Ceramic shelf 4. Splash cover 5. Oven lamp 6. Door hinges 7. Door (glass) 8. Door latches 9. Door handle | <ol style="list-style-type: none"> 10. Door seals and sealing surfaces 11. Air intake filter (air intake openings) 12. Filter knob 13. Outer cabinet 14. Ventilation openings 15. Power supply cord 16. Mounting plate 17. Screw for mounting plate |
|---|---|

CONTROL PANEL

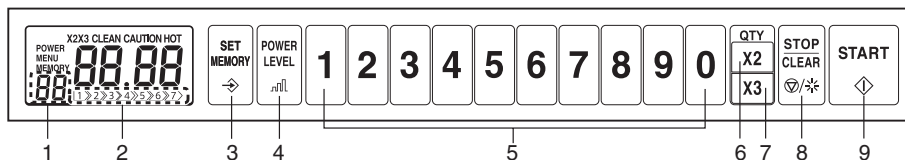

DISPLAY INFORMATION

- MEMORY :** MEMORY will appear when saving, checking or deleting memory programs. It is also shown during Program Lock, Oven Lamp or Audible Signal Sound setting.
- MENU :** MENU will appear when selecting memory number.
- POWER :** POWER will appear when selecting microwave power level.
- X2, X3 :** X2 or X3 will appear when selecting double or triple quantity.
- CLEAN CAUTION :** CLEAN CAUTION will appear when the cleaning of the air intake filter should be necessary.
- HOT:** HOT will appear when the oven is very hot.

1. Memory number/Power level indicator
2. Cooking stage indicators

OPERATING PADS

3. SET MEMORY pad
4. POWER LEVEL pad
5. Ten number pads
6. DOUBLE QUANTITY pad
7. TRIPLE QUANTITY pad
8. STOP/CLEAR pad
9. START pad

ACCESSORIES

Check to make sure the following accessories are provided:

- Operation manual
- Touch guide
- Caution sheet
(SPECIAL INSTRUCTIONS AND WARNINGS)

NOTE:

- When you order accessories, please mention the two items: part name and model name to your dealer or SHARP authorized service agent.
- The model name is printed on the door of the microwave oven.

SHORT DESCRIPTION OF FEATURES

Program Lock:

You can limit functions available to prevent misuse. The oven has 3 kinds of Program Lock Setting; LL1 (Lock Level 1), LL2 (Lock Level 2) and L (Unlocked) LL1 is the factory setting. See page EN-11.

Manual operation:

For individual cooking and defrosting of different types of food by setting of time and power.

Multiple sequence cooking:

Programming of 2-7 different cooking times and power levels, running automatically.

Repeat cook:

After manual operation it is possible to use same cooking time and power level again just by pressing the START pad within 2 minutes.

Memory function:

Preprogrammed cooking times and power levels (possible to change individually).

Double/Triple quantity function:

By pressing DOUBLE QUANTITY or TRIPLE QUANTITY pad beforehand, the oven calculates the cooking time for the double/triple amount of food on Memory function.

Counter function:

The oven counts automatically all operations.

Error message:

Mistakes in operation of technical problems are displayed with an Error code.

BEFORE OPERATION

- * Before operating your new oven, make sure you read and understand this operation manual completely.
- 1) Plug in the oven. Nothing will appear in the display at this time.
- 2) Open the door. The display shows "0".
- 3) Close the door.

Cancellation:

1. Cooking data is cancelled when pads are not pressed for more than 3 minutes when setting programming.
2. Cooking stops when the STOP/CLEAR pad is pressed and cooking data remains. However if subsequent pads are not pressed within 3 minutes, cooking data will be cancelled.

- To resume cooking press the START pad.
3. Cooking stops when the door is opened and cooking data remains. However cooking data will be cancelled if the oven is left for 3 minutes. To resume cooking press the START pad.
 4. Cooking is immediately cancelled by pressing the STOP/CLEAR pad twice.

Cooking Completion:

When food is not taken out after cooking completion, "0000" will be flashing in the display until the food is taken out.

If you do not operate the oven for 2 minutes when the display shows "0", your oven automatically shuts down, so you will not be able to operate the oven until you open and close the oven door.

NOTE : The cooling fan works after cooking, your oven will not shut down automatically.

HOW TO OPERATE THE OVEN

MEMORY OPERATION

MEMORY COOKING

- * Your oven has 30 memory banks from 1 to 30. Input one, two, or three numbers to select a memory. See the table of Memory Input Method on the right side.
- * Memory 1-10 are programmed as factory settings. See the table of Programmed Memories on the right side. Memory 11-30 must be programmed before using Memory Cooking. See SAVING MEMORIES on page EN-8 to program a new memory.

Memory Input Method

Memory No. examples	2	12	22
Number pad to press	2	2, 2	2, 2, 2

Programmed Memories (Output power is 1800 W for all)

Memory No.	Number pad to press	Cook time	Memory No.	Number pad to press	Cook time
1	1	10 sec.	6	6	1min.
2	2	20 sec.	7	7	1min. 10 sec.
3	3	30 sec.	8	8	1min. 20 sec.
4	4	40 sec.	9	9	1min. 30 sec.
5	5	50 sec.	10	0	1min. 40 sec.

Memory Cooking can be started in 2 operating ways.

1. Program Lock Setting: LL1 or LL2
2. Program Lock Setting: L



1. Program Lock Setting: LL1 or LL2 (without the START pad)

- * Suppose you want to cook with memory 2.

Procedure	
1 Place food in the oven. Then close the door. Enter memory number.	

2. Program Lock Setting: L (with the START pad)

- * Suppose you want to cook with memory 12.

Procedure	
1 Place food in the oven. Then close the door. Enter memory number.	 x 2
2 Press the START pad.	



NOTE :

To change the Program Lock Setting, see page EN-11.

COOKING DOUBLE/TRIPLE QUANTITY WITH MEMORY

Double/Triple Quantity is a feature where the oven will automatically calculate how to cook two or three servings of a programmed food. It does not simply double or triple the time. Factory setting is multiplication factor 1.8 for double quantity and 2.6 for triple quantity.

- * Suppose you want to cook 3 servings with memory number 2 with Program Lock Setting LL1.

Procedure	
1 Place food in the oven. Then close the door. Press the TRIPLE QUANTITY pad.	 x 3
2 Enter memory number.	

NOTE :

Press the START pad after step 2 when the oven is set at Program Lock Setting L.

SAVING MEMORIES

- * Saving Memories is available when the oven is set at the Program Lock Setting L. See page EN-11.
- * Memory 1-10 are programmed as factory settings. See the table of Programmed Memories on page EN-7.
- * Memories must be programmed before memory cooking can be used.

Memory banks: 1-30

Power levels: 0-13 (See page EN-10)

Maximum Cooking Time:

Single stage cooking

Power Level 13-6: 15 minutes

Power Level 5-0: 60 minutes

Multi stage cooking

Total Cooking Time: 75 minutes

Details:

Power Level 13-6: a total of 15 minutes







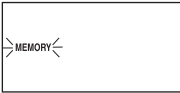

Power Level 5-0: a total of 60 minutes

Maximum cooking stages: 7 stages

Multiplication factor for double/triple quantity: 0.01-9.99

1. Setting power level and time

- * Suppose you want to set 1 minute on 1500 W with memory 2.







Procedure	Display
1 Set the oven L (unlocked). Close the door.	
	
2 Press the SET MEMORY pad.	
	
3 Enter memory number.	
 x 4	
4 Enter power level.	
	
5 Enter cooking time.	
	
6 Press the SET MEMORY pad to save the memory.	

NOTES :

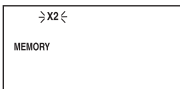
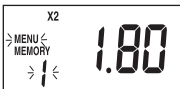
1. To set more than 2 stages, repeat steps 4 and 5 before pressing the SET MEMORY pad in step 6. When pressing the SET MEMORY pad in step 6, the total cooking time will be shown in the display.
2. If the programmed cooking time is over the maximum time:
 - * the SET MEMORY pad will be invalid.
 - * the power level for the next stage will not be entered.
3. To delete the program, press the POWER LEVEL pad once in step 4. Then press the STOP/CLEAR pad.

2. Setting multiplication factor for double/triple quantity

- * Suppose you want to set the multiplication factor to 2.00 for double quantity in memory 1.

Procedure	Display
1 Set the oven L (unlocked). Close the door.	
 x 2	
2 Press the SET MEMORY pad. Then press the DOUBLE QUANTITY pad.	
1	
3 Enter memory number.	
	
4 Press the POWER LEVEL pad.	
2 0 0	
5 Enter desired multiplication. (Ex : Enter 2, 0, 0 for 2.00.)	
	
6 Press the SET MEMORY pad to save the memory.	

NOTES :



- The multiplication factors can be set from 0.01 to 9.99 for double quantity and triple quantity.
- When you want to set the multiplication factor for triple quantity, press the TRIPLE QUANTITY pad at step 2 after pressing the SET MEMORY pad.

MEMORY CHECK

Use this function to check the programming for each memory bank.

1. To check the memory program

- * Suppose you want to know the information programmed into memory.

Procedure	Display
1 Open the door.	
 for 2 sec. 1	
2 Press the STOP/CLEAR pad for 2 seconds. Then press the 1 pad when you hear a short beep. (The program of each memory bank will be shown for 2 seconds in numbering order)	



x 2

0

- Press the STOP/CLEAR pad twice to exit from the Memory Check. Then close the door.



NOTES :

- To pause, press the STOP/CLEAR pad once. To continue Memory Check, press the START pad.
- To check the program of a certain memory bank, enter its memory number during the pause.

2. To check the multiplication factor

You can check the multiplication factors of the double and triple quantities for memory cooking.

- * Suppose you want to know the multiplication factors of the double quantity for memory cooking.

Procedure	Display
1 Open the door.	
 for 2 sec. 2	
2 Press the STOP/CLEAR pad for 2 seconds. Then press the 2 pad when you hear a short beep. (The multiplication factor of each memory bank will be shown for 2 seconds in numbering order)	
 x 2	0
3 Press the STOP/CLEAR pad twice to exit from the Memory Check. Then close the door.	

NOTES :

- To pause, press the STOP/CLEAR pad. To continue Memory Check, press the START pad.
- To check the multiplication factor of a certain memory bank, enter its memory number during the pause.
- When you want to know the multiplication factor for triple quantity, press the 3 pad after pressing the STOP/CLEAR pad for 2 seconds at step 2.

MANUAL OPERATION

MANUAL COOKING

Manual Cooking is available when the oven is set the Program Lock Setting LL1 or L. See page EN-11.

Your oven can be programmed for up to 7 cooking stages and has 14 preset microwave power levels.

Microwave Power Level

Output power	Number of times to press the POWER LEVEL pad	Display (POWER LEVEL)
1800 W	× 1	13
1700 W	× 2	12
1600 W	× 3	11
1500 W	× 4	10
1400 W	× 5	9
1300 W	× 6	8
1200 W	× 7	7
1100 W	× 8	6
1000 W	× 9	5
750 W	× 10	4
500 W	× 11	3
340 W	× 12	2
150 W	× 13	1
0 W	× 14	0



1. Single stage cooking

Maximum Cooking Time

Power Level 13-6: 15 minutes

Power Level 5-0: 60 minutes

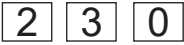
* Suppose you want to cook for 2 minutes and 30 seconds on 1500 W.

Procedure	
1 Place food in the oven. Then close the door. Enter power level.	 x 4
2 Enter cooking time.	
3 Press the START pad.	

NOTES :

- If the programmed cooking time is over the maximum time, the START pad will be invalid.
- After cooking, you can cook with the same setting as the previous one by pressing the START pad within 2 minutes.

2. Multi stage cooking

Maximum Cooking Time







Total Cooking Time: 75 minutes

Details:

Power Level 13-6: a total of 15 minutes

Power Level 5-0: a total of 60 minutes

* Suppose you want to cook for 1 minute on 1500 W for 1st stage and then continue to cook for 2 minutes on 1000 W for 2nd stage and to cook for 3 minutes on 500 W for 3rd stage.

Procedure	
1 Place food in the oven. Then close the door. Enter power level for 1st stage.	 x 4
2 Enter cooking time for 1st stage.	
3 Enter power level for 2nd stage.	 x 9
4 Enter cooking time for 2nd stage.	
5 Enter power level for 3rd stage.	 x 11
6 Enter cooking time for 3rd stage.	
3 Press the START pad.	

NOTES :

- The total cooking time will be shown in the display when pressing the START pad.
- If the programmed cooking time is over the maximum time:
 - * the power level for the next stage will not be entered.
 - * the START pad will be invalid.
- After cooking, you can cook with the same setting as the previous one by pressing the START pad within 2 minutes.

OTHER CONVENIENT FEATURES

PROGRAM LOCK SETTING

You can limit functions available to prevent misuse.

The oven has 3 kinds of Program Lock Setting;

L : Unlocked

LL1 : Lock Level 1 = Factory Setting

LL2 : Lock Level 2

The factory setting is LL1 (Lock Level 1). Under LL1 and LL2, cooking will automatically start after the memory number is input. Under L (Unlocked), cooking will not begin until the START pad is pressed.





LL1 is suitable when using both memory and manual cooking. LL2 is suitable when using memory cooking only. When saving memories, changing oven lamp or audible signal sound setting, the oven should be set at L (Unlocked).

Operation for each Program Lock Level

✓ : Available ✗ : Not available

Operation	L	LL1	LL2
Memory Cooking	✓	✓	✓
Memory Check	✓	✓	✓
Manual Cooking	✓	✓	✗
Saving Memories	✓	✗	✗
Oven Lamp Setting	✓	✗	✗
Audible Signal Sound setting	✓	✗	✗
Counter Check	✓	✓	✓

* Suppose you want to set the Program Lock Setting LL2 (current setting: LL1)

Procedure	Display
1 Open the door.	
 for 2 sec. 	
2 Press the STOP/CLEAR pad for 2 seconds. Then press the SET MEMORY pad when you hear a short beep.	After 3 sec. 
After 3 seconds, the display will automatically change to "0".	
3 Close the door to exit from the Program Lock Setting function.	

NOTE :











Repeat step 2 to set LL2 → L → LL1 → LL2... in sequence.











OVEN LAMP SETTING

You can check 4 kinds of oven lamp setting, and customize them.

1. ON/OFF during the Door Opening
2. ON/OFF during Cooking
3. ON/OFF at Cooking Completion
4. Brightness during Cooking

* Suppose you want to check or customize the status of all oven lamp settings.

Procedure	Display
1 Set the oven L (unlocked). Close the door.	
 2 Press the SET MEMORY pad.	
<< ON/OFF during the Door Opening >>  3 Press the POWER LEVEL pad repeatedly until the desired setting is displayed.	ON = Factory Setting  ↑ OFF ↓ 
 4 Press the SET MEMORY pad to save the setting.	
 5 Press the POWER LEVEL pad within 3 seconds to proceed to the next setting.	
<< ON/OFF during Cooking >>  6 Press the POWER LEVEL pad repeatedly until the desired setting is displayed.	ON = Factory Setting  ↑ OFF ↓ 
 7 Press the SET MEMORY pad to save the setting.	

 8 Press the POWER LEVEL pad within 3 seconds to proceed to the next setting.	
<< ON/OFF at Cooking Completion >>  9 Press the POWER LEVEL pad repeatedly until the desired setting is displayed.	OFF = Factory Setting  ↑ ON (flashing) ↓ 
 10 Press the SET MEMORY pad to save the setting.	
 11 Press the POWER LEVEL pad within 3 seconds to proceed to the next setting.	
<< Brightness during Cooking >>  12 Press the POWER LEVEL pad repeatedly until the desired setting is displayed.	Full brightness = Factory Setting  ↑ Half brightness ↓ 
 13 Press the SET MEMORY pad to save and exit the setting.	

NOTES :

1. To change the Program Lock Setting, see page EN-11.
2. The setting of Brightness during Cooking is invalid while you set the oven lamp is OFF during cooking.

AUDIBLE SIGNAL SOUND SETTING

You can check 4 kinds of sound settings, and customize them.









1. Sound Volume
2. Sound Pattern of Cooking Completion Alarm
3. Sound Pitch of Cooking Completion Alarm
4. Sound Pitch of Filter Cleaning Reminder









There are several options in each setting, which are shown as a number under MEMORY indicator.

EX: Sound Volume (2: Medium)



* Suppose you want to check or customize the status of all audible signal sound settings.

Procedure	Display
1 Set the oven L (unlocked). Close the door.	
 2 Press the SET MEMORY pad.	
<< Sound Volume >>  3 Press the START pad repeatedly until the desired setting is displayed.	 The number 0 to 3 will appear under MEMORY indicator. 2 = Factory Setting 0 : Mute 1 : Small 2 : Medium 3 : Large
 4 Press the SET MEMORY pad to save the setting.	
 5 Press the START pad within 3 seconds to proceed to the next setting.	
<< Sound Pattern of Cooking Completion Alarm >>  6 Press the START pad repeatedly until the desired setting is displayed.	 The number 1 to 5 will appear under MEMORY indicator. 5 = Factory Setting 1 : 3 short beeps 2 : Short beeps, repeating for 1 min. 3 : A beep for 3 sec., then 3 short beeps after 30 and 60 sec. 4 : A beep for 4 sec., then 3 short beeps after 30 and 60 sec. 5 : A beep for 5 sec., then 3 short beeps after 30 and 60sec.
 7 Press the SET MEMORY pad to save the setting.	

 8 Press the START pad within 3 proceed to the next setting.	
<< Sound Pitch of Cooking Completion Alarm >>  9 Press the START pad repeatedly until the desired setting is displayed.	 The number 1 to 3 will appear under MEMORY indicator. 3 = Factory Setting 1 : Low 2 : Medium 3 : High
 10 Press the SET MEMORY pad to save the setting.	
 11 Press the START pad within 3 seconds to proceed to the next setting.	
<< Sound Pitch of Filter Cleaning Reminder >>  12 Press the START pad repeatedly until the desired setting is displayed.	 The number 1 to 3 will appear under MEMORY indicator. 3 = Factory Setting 1 : Low 2 : Medium 3 : High
 13 Press the SET MEMORY pad to save and exit the setting.	

NOTE :

To change the Program Lock Setting, see page EN-11.

COUNTER CHECK/CLEAR

Confirm counters are set to "0" before using the oven for the first time.

Counter Check

Counter check can be used to check the total number of times the oven has been used, number of times each memory bank or manual cooking has used, and to check the total usage hour.

Total usage Open the door. Press the STOP/CLEAR pad for 2 seconds. Then press the DOUBLE QUANTITY pad. Total usage will be displayed.









To check more than one counter

Press each pad as indicated below, after the previous usage is displayed.

Total each memory usage Enter memory number.

Total manual cooking usage Press the POWER LEVEL pad.

* Suppose you want to know total usage and each usage. In this case the oven was used 19766 times, memory 7 was used 672 times and manual cooking was used 863 times.

Procedure	Display
1 Open the door.	
 for 2 sec. 	 (Total usage)
2 Press the STOP/CLEAR pad for 2 seconds. Then press the DOUBLE QUANTITY pad when you hear a short beep.	
 Enter memory number 7, to check the total memory usage of memory 7.	 (Times memory 7 used)
3 -----	
 Press the POWER LEVEL pad to check the total manual cooking usage.	 (Times manual cooking used)
4 Press the STOP/CLEAR pad to exit from Counter Check. Then close the door.	

NOTES :





1. Except for total usage, each counter will count up to 9999, and then will automatically reset to 0 and begin counting again. The counter for total usage will count up to 999,999, and then will return to 0.
2. As shown in the example, multiple counters can be checked before pressing the STOP/CLEAR pad to exit.

To check the total operating time

Open the door. Press the STOP/CLEAR pad for 2 seconds. Then press the TRIPLE QUANTITY pad.

The total operating time will be shown by the hour.

* Suppose you want to know the total operating time which has been 172 hours since the last reset.

Procedure	Display
1 Open the door.	
 for 2 sec. 	 (Total operating time)
2 Press the STOP/CLEAR pad for 2 seconds. Then press the TRIPLE QUANTITY pad when you hear a short beep.	
	
3 Press the STOP/CLEAR pad to exit from Counter Check. Then close the door.	

NOTE :

The counter for total usage hour will count up to 9999 hours, and then will return to 0.

To Reset the Counter to "0"

Each counter can be manually reset to "0" by pressing the SET MEMORY pad for 2 seconds after the count is displayed.

CARE AND CLEANING

CLEAN THE OVEN AT REGULAR INTERVALS AND REMOVE ANY FOOD DEPOSITS - Keep the oven clean, or the oven could lead to deterioration of the surface. This could adversely affect the life of the appliance and possibly result in a hazardous situation. UNPLUG THE APPLIANCE BEFORE CLEANING.

VERY IMPORTANT CAUTIONS:

- DO NOT OPERATE THE OVEN WITHOUT THE SPLASH COVER AND AIR INTAKE FILTER IN PLACE.
- DO NOT USE COMMERCIAL OVEN CLEANERS, ABRASIVE, HARSH CLEANERS OR SCOURING PADS ON ANY PART OF YOUR MICROWAVE OVEN.
- DO NOT SPRINKLE WATER ONTO THE OVEN DIRECTLY. IT MAY CAUSE ELECTRIC SHOCK, LEAKAGE OF ELECTRICITY OR DAMAGE OF THE OVEN.
- THE OVEN SHOULD NOT BE CLEANED WITH A WATER JET. FAILURE TO MAINTAIN THE OVEN IN A CLEAN CONDITION COULD LEAD TO DETERIORATION OF THE SURFACE THAT COULD ADVERSELY AFFECT THE LIFE OF THE APPLIANCE AND POSSIBLY RESULT IN A HAZARDOUS SITUATION.

OVEN EXTERIOR

The outside of your oven can be cleaned easily with mild soap and water. Make sure that the soap is wiped off with a moist cloth, and dry the exterior with a soft towel.

CONTROL PANEL

Care should be taken in cleaning the control panel. Using a cloth dampened with water only, gently wipe the panel until it becomes clean. Avoid the use of excess water. Do not use any sort of chemical or abrasive cleaner. To do so may cause severe damage to the panel and make key entry impossible.

OVEN INTERIOR

- 1) For easy cleaning, wipe any spatters or spills with a soft damp cloth or sponge at the end of each day for hygienic reasons. For heavier spills, use mild soap and wipe several times with a damp cloth until all residues are removed. Built-up splashes may overheat and begin to smoke or catch fire, and cause arcing.
- 2) Keep the ceramic floor clean at all times. If you leave grease or fat in the cavity, it may overheat, smoke or even catch fire when next using the oven.

Operating the unit with excessive buildup may result in cracking or breakage of the ceramic shelf. Do not operate the unit with a cracked or broken ceramic shelf.

CAUTION: Do not remove the Ceramic Shelf from the oven.

- 3) Make sure that mild soap or water does not penetrate through the small vents in the walls which may cause damage to the oven.
- 4) Do not use spray type cleaners on the oven interior.

SPLASH COVER

Remove the splash cover and wash both sides of it in a mild detergent solution. Built-up grease may overheat and begin to smoke. And overheated grease may burn the splash cover. The splash cover is located in the top of the oven and may easily be removed. Remember to unplug the power cord.

Removal:

While pinching the stoppers of the splash cover, pull it gently downward.

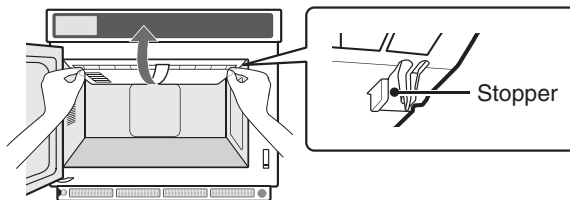

Reinstall:

Insert 2 projections into the 2 holes on the rear cavity wall and then replace the splash cover to the oven ceiling while pinching the stoppers at the front side of it.

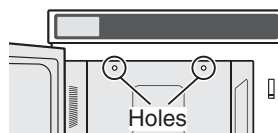

DOOR

To remove all trace of dirt, regularly clean both sides of the door, the door seals and adjacent parts with a soft, damp cloth. Always keep the door seals and seal surfaces clean so that any grease, spills or spatters are not allowed to build up. Build-up could result in leakage of microwave energy from the oven.

AIR INTAKE FILTER

Keep clean the air intake filter. Clean the air intake filter once a week. Wash the air intake filter in mild soapy water and dry with a soft cloth. After cleaning re-install the air intake filter to the oven.

Removal:

Pull the filter knob on the right side, then slide it to the right.

Reinstall:

Insert the gap of the filter to the pin on the left side, then attach the filter knob onto the right side of the oven.

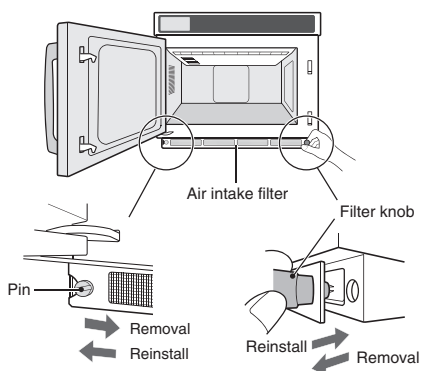

The timing to clean the air intake filter will be announced by the "CLEAN CAUTION" indicator and sound. After maintenance, press the STOP/CLEAR pad for 2 seconds to turn off the indicator.

SERVICE CALL CHECK

Please check the following before calling for service.

- * Power Supply
Check the power plug is properly connected to a suitable wall outlet.
Check the line fuse/circuit breaker is functioning properly.

QUESTION / SITUATION	ANSWER
"CC with number" appears.	<ul style="list-style-type: none"> • Call for service to replace the parts promptly. It will be shown for 1 minute when opening the door after cooking. Failure to replace parts that have exceeded recommended operation time may cause failure of the microwave oven.
At cooking completion, the cooling fan will run (up to 30 minutes)	<ul style="list-style-type: none"> • The cooling fan will automatically run to eject odours from the oven interior.
The oven will not power up.	<ul style="list-style-type: none"> • Opening the door initiates power to the oven, and "0" is displayed.
Memory cooking does not start when pressing a number pad.	<ul style="list-style-type: none"> • Are you operating the oven with Program Lock Setting LL1 or LL2? See page EN-11. • When you use the oven with Program Lock Setting L, press the START pad after pressing the number pad.
<ul style="list-style-type: none"> • Manual cooking does not start. • The oven does not save memories. • Then oven cannot be customised. 	<ul style="list-style-type: none"> • Are you operating the oven with Program Lock Setting L? See page EN-11. Manual cooking is available when the oven is set at the Program Lock Setting LL1 or L.
Food is not well-cooked.	<ul style="list-style-type: none"> • Did you cook the food with suitable power level and time? • For memory cooking, is the program (power level or time) of the memory bank is correct? • When repeating heating with output of 1600 W or more without a time interval and total heating time exceeds 10 minutes, output may switch to 1500 W to protect parts. When you suspect that cooking temperature has changed during continuously repeated heating, interrupt heating for 1 minute and 40 seconds or more, and then proceed.
Food is not being warmed.	<ul style="list-style-type: none"> • Are you using materials that reflect radio waves, such as metal containers or aluminium foil?
There is an odour of sparks or smoke being emitted.	<ul style="list-style-type: none"> • Are you using a steel skewer, aluminium foil, gold or silver inlay pattern ware, or metal containers? • Is metal (aluminium foil, steel skewer etc.) touching the interior walls of the oven? • Are there any food soils in the oven? Clean the oven interior. *: This function will also apply for the next cooking when the continued cooking time on 1500W exceeds 10 minutes.
The oven shows "EE17" and stops.	<ul style="list-style-type: none"> • Is food in the oven? Put the food in the oven. • Check that nothing is blocking air intake openings on oven back or that oven exterior is very hot. Correct. Wait a few minutes and try again. • Clean the air intake filter and the ventilation openings.
The oven shows "EE20" and stops.	<ul style="list-style-type: none"> • Is food in the oven? Put the food in the oven. • The oven exterior is very hot. Did you enter the suitable time or power level?

If there is still an abnormality, stop using the appliance and be sure to unplug it from the power source. Then call for service.

Error message:

Any time "EE with number (except for 17 and 20)" or "CC with number" will appears, call for service.

GUIDE

USEFUL THINGS TO KNOW ABOUT MICROWAVES

Microwaves set the water molecules contained in the food vibrating. The resulting friction generates heat that can be used to defrost or cook the food.

Food

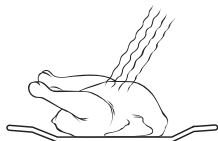

The microwaves are absorbed by the food

SUITABLE UTENSILS

Glass, Glass-ceramics and Porcelain

Heat-resistant utensils made of glass, glass-ceramic or porcelain are suitable. However, the utensils must not contain metals (e.g., lead crystal) or be metal-plated (e.g., gold rim, cobalt blue).

Glass, Porcelain, Ceramics Plastics, paper etc.

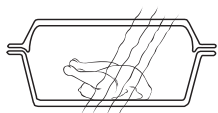

Microwaves pass through

Ceramics

are usually suitable but they must be enamelled. When using utensils that are not enamelled, moisture can be absorbed by the material and heat it up. This can cause the material to crack.

Plastics and Paper Dishes

Heat-resistant and microwave-proof plastic utensils or paper dishes are suitable for defrosting, heating and cooking. Please follow the manufacturer's instructions.

Microwave Plastic Wrap

or heat-resistant wrap is suitable for covering and wrapping food. Please follow the manufacturer's instructions.

Roasting Bags

can be used in microwave ovens. Do not close the bags with a metal clip because the clip may cause the bag film to melt. Close the bag with string and pierce it several times with a fork. Films that are not heat-resistant, e.g., films to retain product freshness are not recommended for use in microwave ovens.

Metals

should not, as a rule, be used in microwave ovens because microwaves cannot penetrate metals and reach the food inside. There are, however, some exceptions: Small strips of aluminium foil can be used to cover parts to prevent them from defrosting or cooking too fast (e.g., chicken wings).

Metal

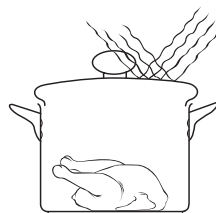

Microwaves are reflected

Small metal skewers and aluminium trays (of prepackaged food) may be used. However, they must be small in proportion to the food. Aluminium containers, for example, must be filled to at least $\frac{2}{3}$ to $\frac{3}{4}$ with food. It is recommendable to transfer the food into microwave-safe containers.

When using aluminium trays or other metal utensils, they must be placed at least 2.0 cm away from the cavity walls. Otherwise the cavity walls may be damaged by sparking.

Do not use any utensils with metal-plating, metal parts or metal projections like screws, ribbons, or handles.

TESTING UTENSILS

Perform the following test if you are unsure whether a certain utensil is microwave-safe: Place the utensil into the oven, put a glass containing about 150 ml of water on or beside the utensil, and operate the microwave oven on 1800 W for 1 to 2 minutes. If it is cool or lukewarm to the touch, the utensil is suitable for microwave use. Do not perform this test on plastic dishes because the plastic might melt.

INFORMATION ABOUT POWER LEVEL

1800-1300 W (POWER LEVEL 13-8):

The high power is perfect for warming up or regenerating food. You can also use it to make food boil e.g. water and then cook further with lower power. (e.g. for rice or noodles)

1200-750 W (POWER LEVEL 7-4):

For longer cooking times and compact types of food.

500 W (POWER LEVEL 3):

For delicate cooking. Also after cooking to simmer or for noodles and rice.

340-150 W (POWER LEVEL 2-1):

The low power level is mainly for defrosting. You can also use it for cooking of very delicate menus like cheese sauce.

Basically it is recommendable to cover the food for cooking or reheating. Additionally you can sprinkle some water over the food (you can also use salted water or even bouillon).

The water steam keeps the food moist and it also helps to make the cooking faster.

SPECIFICATIONS

AC Line Voltage..... Single phase 230-240 V, 50 Hz
Distribution line fuse/
circuit breaker..... 16A(time lag)
AC Power Required..... 2.85 kW
Output Power 1800 W (IEC 60705)
Microwave Frequency 2450 MHz* (Group 2 / Class B)
Sound level..... less than 70dB (A)
Outside Dimensions 420(W) x 337(H) x 480(D) mm
(Single)
420(W) x 674(H) x 480(D) mm
(Two ovens stacked)
Cavity Dimensions..... 332(W) x 171.5(H) x 330(D) mm
Oven Capacity..... 0.7 cu.ft (19 litres)
Cooking Uniformity..... Rotary antenna system
Weight Approx. 20kg

• As part of a policy of continuous improvement, we reserve the right to alter design and specification without notice.

* This Product fulfils the requirement of the European standard EN55011. In conformity with this standard, this product is classified as group 2 class B equipment. Group 2 means that the equipment intentionally generates radio-frequency energy in the form of electromagnetic radiation for heating treatment of food. Class B equipment means that the equipment suitable to be used in domestic establishments. This product is designed for commercial application only and as such it falls outside the scope of Regulation (EC) 1275/2008 implementing EU Directive 2005/32/EC on eco-design requirements for standby and off mode electric power consumption. Sharp do not recommend the product for domestic application and will not accept any liability for such use.

NOTE: External equipotential bonding terminal

This appliance has an external equipotential bonding terminal, and this symbol is on the back of the microwave oven.



EN

Manufacturer:

SHARP Corporation

1 Takumi-cho, Sakai-ku, Sakai-shi, Osaka 590-8522, Japan

Authorised Representative:

SHARP Electronics GmbH,

Nagelsweg 33 - 35, 20097 Hamburg, Germany



SDA/MAN/0300 V2

www.sharpconsumer.eu

SHARP

TINSMA099WRRZ-H31