

COMMERCIAL MICROWAVE OVEN



EN

Original Instruction

OPERATION MANUAL - This operation manual contains important information which you should read carefully before using your microwave oven.

IMPORTANT:

There may be a serious risk to health if this operation manual is not followed or if the oven is modified so that it operates with the door open.

YB-S4202AE 2100W(IEC 60705)



Information on the Disposal of this Equipment

IF YOU WISH TO DISPOSE OF THIS EQUIPMENT, DO NOT USE THE ORDINARY WASTE BIN, AND DO NOT PUT THEM INTO A FIREPLACE!

Used electrical and electronic equipment should always be collected and treated SEPARATELY in accordance with local law.

Separate collection promotes an environment-friendly treatment, recycling of materials, and minimizing final disposal of waste. IMPROPER DISPOSAL can be harmful to human health and the environment due to certain substances! Take USED EQUIPMENT to a local, usually municipal, collection facility, where available.

If in doubt about disposal, contact your local authorities or dealer and ask for the correct method of disposal.

ONLY FOR USERS IN THE EUROPEAN UNION, AND SOME OTHER COUNTRIES; FOR INSTANCE NORWAY AND SWITZERLAND: Your participation in separate collection is requested by law.

The symbol shown above appears on electrical and electronic equipment (or the packaging) to remind the users of this.

Users from PRIVATE HOUSEHOLDS are requested to use existing return facilities for used equipment. Return is free of charge.

If the equipment has been used for BUSINESS PURPOSES, please contact your SHARP dealer who will inform you about take-back. You might be charged for the costs arising from take-back. Small equipment (and small quantities) might be taken back by your local collection facility. For Spain: Please contact the established collection system or your local authority for take-back of your used products.



[www.sharpconsumer.com/
documents-of-conformity/](http://www.sharpconsumer.com/documents-of-conformity/)

Declarations of conformity are available from
www.sharpconsumer.com/documents-of-conformity/

CONTENTS

| | | | |
|-------------------------------------|------|----------------------------------|-------|
| PART NAMES | EN-3 | MANUAL OPERATION | EN-11 |
| IMPORTANT SAFETY INSTRUCTIONS | EN-4 | OTHER CONVENIENT FUNCTIONS | EN-14 |
| INSTALLATION INSTRUCTIONS | EN-6 | CARE AND CLEANING | EN-16 |
| ACCESSORIES | EN-7 | SERVICE CALL CHECK | EN-17 |
| SHORT DESCRIPTION OF FEATURES | EN-7 | GUIDE | EN-18 |
| BEFORE OPERATION | EN-7 | SPECIFICATIONS | EN-21 |
| PROGRAMME OPERATION | EN-8 | | |

PART NAMES

OVEN

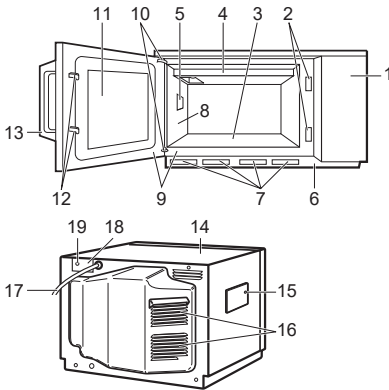

- 1 Control panel
- 2 Door lock openings
- 3 Ceramic floor
- 4 Splash cover
- 5 Oven lamp
- 6 Air intake filter
- 7 Air intake openings
- 8 Oven cavity
- 9 Door seals and sealing surfaces
- 10 Door hinges
- 11 Door
- 12 Safety door latches
- 13 Door open handle
- 14 Outer cabinet
- 15 Oven lamp access cover
- 16 Ventilation openings
- 17 Power supply cord
- 18 Mounting plate
- 19 Screw for mounting plate

AUTO-TOUCH CONTROL PANEL

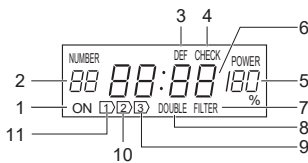

DISPLAY AND INDICATORS

Check indicators after the oven starts to confirm the oven is operating as desired.

- 1 Cook indicator
This indicator shows cooking in progress.
- 2 Memory number indicator
- 3 Defrost indicator
- 4 Check mode indicator
- 5 Microwave power level indicator
- 6 Digital display
- 7 Filter indicator
- 8 Double quantity indicator
- 9 3rd stage indicator
- 10 2nd stage indicator
- 11 1st stage indicator

OPERATING KEYS

- 12 DOUBLE QUANTITY key
- 13 EXPRESS DEFROST key
- 14 NUMBER keys
- 15 MANUAL/REPEAT keys
- 16 STOP/CLEAR key
- 17 SELECT POWER key
- 18 START key
- 19 SET key
- 20 SIGNAL key
- 21 CHECK key

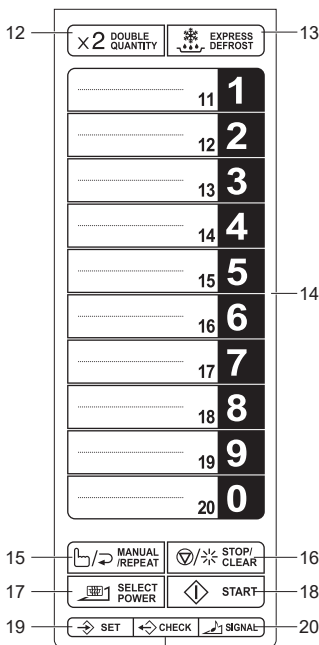

IMPORTANT SAFETY INSTRUCTIONS

IMPORTANT SAFETY INSTRUCTIONS: READ CAREFULLY AND KEEP FOR FUTURE REFERENCE

1. This appliance is intended to be used by expert or trained user in shops, in light industry and on farms, or for commercial use by lay persons.
2. This oven is designed to be used on a countertop only. It is not designed to be built into a kitchen unit. Do not place the oven in a cabinet.
3. The electrical outlet must be readily accessible so that the unit can be unplugged easily in an emergency. **If smoke or burn is observed: Keep the oven door closed** and switch off the power by disconnecting the plug from the socket in order to stifle any flames. Failure to follow this procedure may result in fire and oven damage.
4. Ensure there is a minimum of free space above the oven of 25 cm.
5. This appliance is not intended for use by persons (including children) with reduced physical, sensory or mental capabilities, or lack of experience and knowledge, unless they have been given supervision or instruction concerning use of the appliance by a person responsible for their safety.
6. Children should be supervised to ensure that they do not play with the appliance.
7. **WARNING:** Only allow children to use the oven without supervision when adequate instructions have been given so that the child is able to use the oven in a safe way and understands the hazards of improper use.
8. **WARNING:** If the door or door seals are damaged, the oven must not be operated until it has been repaired by a competent person.
9. **WARNING:** Never adjust, repair or modify the oven yourself. It is hazardous for anyone other than a competent person to carry out any service or repair operation which involves the removal of a cover which gives protection against exposure to microwave energy.
10. If the power supply cord of this appliance is damaged, it must be replaced by an authorised SHARP service agent in order to avoid a hazard.
11. **WARNING:** Liquids and other foods must not be heated in sealed containers since they are liable to explode.
12. **WARNING:** Microwave heating of beverages can result in delayed eruptive boiling, therefore care must be taken when handling the container.
13. Do not cook eggs in their shells, and whole hard boiled eggs should not be heated in microwave ovens since they may explode even after microwave cooking has ended. To cook or reheat eggs which have not been scrambled or mixed, pierce the yolks and the whites, or the eggs may explode. Shell and slice hard boiled eggs before reheating them in the microwave oven.
14. Utensils should be checked to ensure that they are suitable for use in the oven. See "GUIDE" on page EN-18. Use only microwave safe containers and utensils.

15. **WARNING:** The contents of feeding bottles and baby food jars must be stirred or shaken and the temperature checked before consumption, in order to avoid burns.
16. When heating food in plastic or paper containers, keep an eye on the oven due to the possibility of ignition.
17. Clean the oven at regular intervals and remove any food deposits.
18. Failure to maintain the oven in a clean condition could lead to deterioration of the surface that could adversely affect the life of the appliance and possibly result in a hazardous situation.
19. See instructions for cleaning door seals, cavities and adjacent parts on page EN-16-EN-17.
20. The oven should not be cleaned with a water jet.

To avoid the danger of fire

1. **The microwave ovens should not be left unattended during operation. Power levels that are too high or cooking times that are too long may overheat foods resulting in a fire.**
2. The AC power supply must be 230 V, 50 Hz, with a minimum 16 A distribution line fuse, or a minimum 16 A distribution circuit breaker. In using two ovens, each oven must be secured with a 16 A distribution line fuse or a distribution circuit breaker.
3. A separate circuit serving only this appliance should be provided.
4. Do not place the oven in areas where heat is generated. For example, close to a conventional oven.
5. Do not install the oven in an area of high humidity or where moisture may collect.
6. Do not store or use the oven outdoors.
7. **Clean the splash cover and the oven cavity after use. These must be dry and free from grease. Built-up grease may overheat and begin to smoke or catch fire.**
8. Do not place flammable materials near the oven or ventilation openings.
9. Do not block the ventilation openings.
10. Remove all metallic seals, wire twists, etc., from food and food packages. Arcing on metallic surfaces may cause a fire.
11. Do not use the microwave oven to fry with oil or heat oil for deep frying. The temperature can not be controlled and the oil catch fire.
12. To make popcorn, use only special microwave makers.
13. Do not store food or any other items inside the oven.
14. Check the settings after you start the oven to ensure the oven is operating as desired.

15. To avoid overheating and fire, special care must be taken when cooking or reheating foods with a high sugar or fat content, for example, Sausage rolls, Pies or Christmas pudding.
16. See the corresponding hints in this operation manual and in the attached cookery book section.

To avoid the possibility of injury

WARNING:

1. Do not operate the oven if it is damaged or malfunctioning. Check the following before use:
 - a) The door; make sure the door closes properly and ensure it is not misaligned or warped.
 - b) The hinges and safety door latches; check to make sure they are not broken or loose.
 - c) The door seals and sealing surfaces; ensure that they have not been damaged.
 - d) Inside the oven cavity or on the door; make sure there are no dents.
 - e) The power supply cord and plug; ensure that they are not damaged.
2. Do not operate the oven with the door open or alter the safety door latches in any way.
3. Do not operate the oven if there is an object between the door seals and sealing surfaces.
4. Do not allow grease or dirt to build up on the door seals and adjacent parts. Follow instructions for "Care and Cleaning", Page EN-16-EN-17.
5. Individuals with PACEMAKERS should check with their doctor or the manufacturer of the pacemaker for precautions regarding microwave ovens.

To avoid the possibility of electric shock

1. Under no circumstances should you remove the outer cabinet.
2. Never spill or insert any objects into the door lock openings or ventilation openings. In the event of a spill, turn off and unplug the oven immediately, and call a SHARP service agent.
3. Do not immerse the power supply cord or plug in water or any other liquid.
4. Do not let the power supply cord hang over the edge of a table or work surfaces.
5. Keep the power supply cord away from heated surfaces, particularly the back of the oven.
6. Unplug the oven before replacing the oven lamp.

To avoid the possibility of explosion and sudden boiling

1. Never use sealed containers. Remove seals and lids before use. Sealed containers can explode due to a build up of pressure even after the oven has been turned off.
2. Take care when microwaving liquids. Use a widemouthed container to allow bubbles to escape.

Never heat liquids in narrow necked containers such as baby bottles, as this may result in the contents erupting from the container when heated and cause burns.

To prevent sudden eruption of boiling liquid and possible scalding:

1. Do not use excessive amount of time (See page EN-19, EN-20).
2. Stir liquid prior to heating/reheating.
3. It is advisable to insert a glass rod or similar utensil (not metal) into the liquid whilst reheating.
4. Let liquid stand for at least 20 seconds in the oven at the end of cooking time to prevent delayed eruptive boiling.
3. Pierce the skin on such foods as potatoes, sausages and fruit before cooking, or they may explode.

To avoid the possibility of burns

1. Use pot holders or oven gloves when removing food from the oven to prevent burns.
2. Always open containers, popcorn makers, oven cooking bags, etc., away from the face and hands to avoid steam burns and eruption of boiling.
3. **To avoid burns, always test food temperature and stir before serving and pay special attention to the temperature of food and drink given to babies, children or the elderly.**
Temperature of the container is not a true indication of the temperature of the food or drink; always check the food temperature.
4. Always stand back from the oven door when opening it to avoid burns from escaping steam and heat.
5. Slice stuffed baked foods after heating to release steam and avoid burns.
6. Keep children away from the door to prevent them burning themselves.
7. Do not touch the back of the oven because it will become hot.

To avoid misuse by children

1. Do not lean or swing on the oven door. Do not play with the oven or use it as a toy.
2. Children should be taught all important safety instructions: use of pot holders, careful removal of food coverings; paying special attention to packaging (e.g. self-heating materials) designed to make food crisp, as they may be extra hot.

Other warnings

1. Never modify the oven in any way.
2. Do not move the oven while it is in operation.
3. This oven is for food preparation only and may only be used for cooking food. It is not suitable for laboratory use.

To promote trouble free use of your oven and avoid damage.

1. Never operate the oven when it is empty. Doing so may damage the oven.
2. When using a browning dish or self-heating material, always place a heat-resistant insulator such as a porcelain plate under it to prevent damage to the ceramic floor due to heat stress. The preheating time specified in the dishes instructions must not be exceeded.
3. Do not use metal utensils, which reflect microwaves and may cause electrical arcing. Do not put cans in the oven.

4. Do not place anything on the outer cabinet during operation.
5. Do not use the oven near a steamer or a fryer.

NOTE

1. If you are unsure how to connect your oven, please consult an authorized qualified electrician.

2. Neither the manufacture nor the dealer can accept any liability for damage to the oven or personal injury resulting from failure to observe the correct electrical connection procedure.
3. Water vapour or drops may occasionally form on the oven walls or around the door seals and sealing surfaces. This is a normal occurrence and is not an indication of microwave leakage or a malfunction.

INSTALLATION INSTRUCTIONS

WARNING: Always keep the caution sheet (SPECIAL INSTRUCTIONS AND WARNINGS) close to the oven for your reference.

- 1) Remove all packing materials from the inside of the oven cavity. Remove all the blue protective film from the outside of the oven.
- 2) Check the oven carefully for any signs of damage.
- 3) Place the oven on a flat, level surface strong enough to support the oven's weight plus the heaviest item likely to be cooked.
Do not place this oven in a position which is not easily accessible. To position the oven too high can be dangerous because food can not be removed safely.
- 4) Ensure there is a minimum free space above the oven of 25 cm.

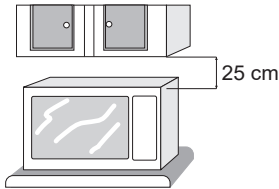

- 5) Securely connect the plug of the oven to a standard earthed (grounded) household electrical outlet.
- 6) Two same oven models can be installed together by placing one on top of another. Follow these instructions.

- 6-1) Place the oven A and position the oven B on top of the oven A as shown in the figure A.
- 6-2) Remove the single screw (a) holding the mounting plate A to the rear cabinet of the oven A. And remove the mounting plate A.
- 6-3) Remove the single screw (b) from the rear cabinet of the oven B, as shown in the figure A.
- 6-4) Reinstall the mounting plate A to the rear cabinet of the oven B with the single screw (b) removed, as shown in the figure A.

- 6-5) Hold the mounting plate A to the rear cabinet of the oven A with the single screw (a), as shown in the figure A.
- 6-6) Remove the screw (a) holding the mounting plate B to the rear cabinet of the oven B. And remove the mounting plate B from the oven B. See the figure A.
- 6-7) Install the screw (a) to its position again.
- 6-8) Remove the screw (c) from the oven A.
- 6-9) Remove the screw (d) from the oven B.
- 6-10) Turn the removed mounting plate B over and then using the removed screw (c) and (d), attach the mounting plate B, as shown in the figure A.

WARNING:

In case where two ovens are installed together by placing one on top of another,

- 1) Use the two mounting plates for fixing the two ovens.
- 2) Make sure that the power supply cord is not caught between the two ovens.
- 3) Do not install more than one oven on top of another.
- 4) Do not lose the removed screws.

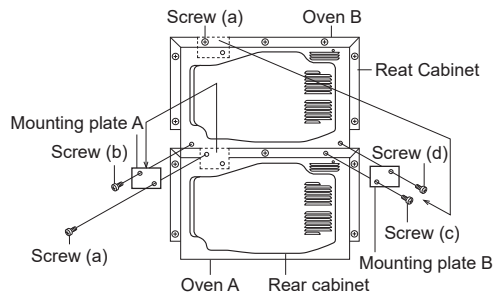

Figure A: How to fix two ovens

ACCESSORIES

Check to make sure the following accessories are provided:

Manuals and others

- Operation manual
- Menu sticker
Enter cooking times or dish names in this sticker and attach to the control panel.
- Caution sheet (SPECIAL INSTRUCTIONS AND WARNINGS)

NOTE:

- When you order accessories, please mention the two items: part name and model name to your dealer or SHARP authorized service agent.
- The model name is printed on the door of the microwave oven.

SHORT DESCRIPTION OF FEATURES

Manual operation

for individual cooking and defrosting of different types of food by setting of time and power.

Multiple sequence cooking:

programming of 2-3 different cooking times and power levels, running automatically.

Repeat cook:

after manual operation it is possible to use same cooking time and power level again just by pressing manual / repeat key and then start key.

Defrost function:

for well defrosting of different types of food, without power level setting.

Memory function:

preprogrammed cooking times and power levels (possible to change individually).

Double quantity function:

by pressing double quantity key beforehand, the oven calculates the cooking time for the double amount of food on Memory function.

Counter function:

The oven counts automatically all operations.

Error message:



Mistakes in operation of technical problems are displayed with an Error code.

Accustical signal:

At cooking end a signal will sound. Loudness and length can be varied.



BEFORE OPERATION

* Before operating your new oven, make sure you read and understand this operation manual completely.

- 1) Plug in the oven.
* The digital display will then show .
- 2) You can input the keys only when the door is closed.
- 3) Oven lamp and fan motor work for 1 minute whenever the door is opened or after cooking.
- 4) The programme and the check are canceled when any keys are not touched for more than 3 minutes during programming.
- 5)  will appear on the display after the timer reaches zero. It will disappear when the oven door is opened or the STOP/CLEAR key () is touched.

Volume and Sound Setting

There are 3 preset volume levels of 2 different-sounds on your oven.

To set the volume and the sound, touch the SET key () twice within 2 second and then touch the SIGNAL key () continuously until you hear desired volume and sound.

NOTE:

1. The volume will decrease as you press the SIGNAL key ().
After the lowest level, the volume will return to the maximum level and the sound will change to another one at the same time.
2. Any audible signals will not sound when the SET key is touched first and then an audible signal will sound when the SET key is touched second.

Using STOP/CLEAR () Key

Use the STOP/CLEAR key () to:

1. Stop the oven temporarily during cooking.
2. Erase a mistake during programming.
3. Cancel a programme during cooking by touching twice.

PROGRAMME OPERATION

This oven has 20 memory banks (1-20) which can store cooking programmes.

The memory banks 1-10 have been programmed previously as shown in the table. These preprogrammed memory banks can be changed individually if required. Please see page EN-9.

In addition for all memory banks a magnification factor 1.8 for the double quantity is stored. The stored magnification factor can also be changed individually if required. Please see page EN-10.

| Memory No. | Cook Time | Output Power | Memory No. | Cook Time | Output Power |
|------------|-----------|--------------|------------|----------------|--------------|
| 1 | 5 sec. | 100% | 6 | 50 sec. | 100% |
| 2 | 10 sec. | 100% | 7 | 1 min. | 100% |
| 3 | 20 sec. | 100% | 8 | 1 min. 15 sec. | 100% |
| 4 | 30 sec. | 100% | 9 | 1 min. 30 sec. | 100% |
| 5 | 40 sec. | 100% | 10 | 2 min. | 100% |

Information in these memory banks is not lost due to power interruptions. If the power goes off, the oven does not need to be reprogrammed. No batteries are necessary for this type of memory.

To check the stored programmes, please refer to "Memory check" on page EN-10.

COOKING WITH MEMORY PROGRAMME

Example : Suppose you want to cook by using memory 1, which was programmed for 5 seconds at 100 %.

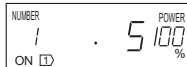

Choose memory number.

After 1 second, the oven starts.
Check the display.

NOTE:

If you want to cook by using memory 11-20, touch the desired NUMBER key twice within 1 second.

Cooking double quantity with memory programme

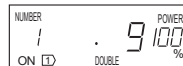

Example : Suppose you want to cook 2 servings by memory 1.



Choose double quantity cooking mode. Choose memory number.

After 1 second, the oven starts.
Check the display.

NOTE:









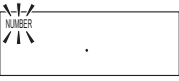
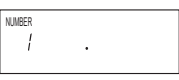

- If you want to cook double quantity by using memory 11-20, touch the desired NUMBER key twice within 1 second.
- Double quantity means best time for cooking two servings; it is not double the time.
 - The Memory cooking system does not require the use of the START key (). Memory can not be used to start the oven if any programme is on display.
 - If the door is opened during memory cooking, the programme is canceled.
 - To stop the cooking of a memory key and then restart, first, touch the STOP/CLEAR key (), then open the door, check food, close door and touch START key ().
 - If the memorized time exceeds a maximum time for double quantity cooking, the display will show "EE9" and stop. You can use the memory for 1 serving cooking only. See page EN-11 about the maximum time.

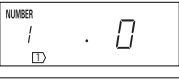
MEMORY SETTING

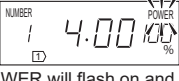
You can change memory programmes for 20 memory banks. Up to three sequences on any power level can be programmed for each memory. See cooking sequence chart on page EN-11 for time maximums.

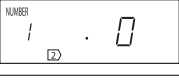
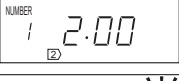
Setting time and power level

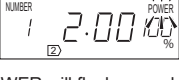
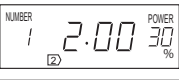
Example : Suppose you want to set 4 minutes at 60 % for the 1st sequence and 2 minutes at 30 % for the 2nd sequence for 1 serving in the memory 1.

| Step | Action | Press key | Display |
|------|--|--|--|
| 1 | Choose set mode. |  × 2 within 2 sec. |  NUMBER will flash on and off. |
| 2 | Choose memory number. | 1 |  |
| 3 | Touch MANUAL/REPEAT key. |  |  |
| 4 | Enter desired cooking time for 1st sequence. | 4 0 0 |  |
| 5 | Touch SELECT POWER key. |  |  POWER will flash on and off. |
| 6 | Choose desired power level for 1st sequence. | 6 |  |
| 7 | Touch MANUAL/REPEAT key. |  |  |
| 8 | Enter desired cooking time for 2nd sequence. | 2 0 0 |  |
| 9 | Touch SELECT POWER key. |  |  POWER will flash on and off. |
| 10 | Choose desired power level for 2nd sequence. | 3 |  |
| 11 | Complete memorizing. |  × 2 |  |









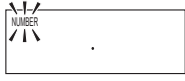

NOTE:

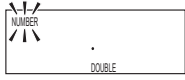
1. If you want to set memory 11-20, touch the desired NUMBER key twice. Ex. 11= **1** × 2, 12= **2** × 2...
2. If 100% is required, it is not necessary to set the microwave power.
3. If the cooking time exceeds the max. time, the display will show EE9.
4. At Step1, any audible signals will not sound when the SET key is touched first and then an audible signal will sound when the SET key is touched second.

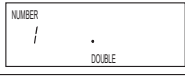
Setting magnification factor

It is possible to change the magnification factor for double quantity in the memory.

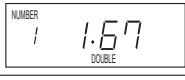
Example : Suppose you want to set the magnification factor to 1.67 for double quantity in memory 1.

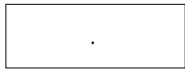
| Step | Action | Press key | Display |
|------|-----------------------------|--|--|
| 1 | Choose set mode. |  SET × 2 within 2 sec. |  |
| 2 | Choose double quantity. |  |  |
| 3 | Choose memory number. |  |  |
| 4 | Touch MANUAL/REPEAT key. |  |  |
| 5 | Enter magnification factor. |  |  |
| 6 | Complete memorizing. |  SET × 2 |  |

NOTE:







1. In case you want to change the magnification factor it must be set for each key separately.
2. The magnification factor can be set from 0.00 to 9.99.
3. At Step 1, any audible signals will not sound when the SET key is touched first and then an audible signal will sound when the SET key is touched second.

MEMORY CHECK

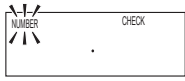
You can check the information programmed into the memory.

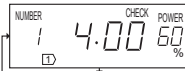
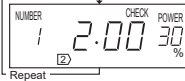
Checking time and power level

Example : Suppose you want to know the information programmed into the memory 1, programmed for 4 minutes at 60% at the 1st sequence and 2 minutes at 30 % at the 2nd sequence, and after that the memory 13, programmed for 3 minutes at 70 %.

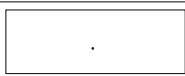





| Step | Action | Press key | Display |
|------|-----------------------|---|--|
| 1 | Choose checking mode. |  |  |
| 2 | Choose memory number. |  |   Repeat |
| 3 | Choose memory number. |  × 2 |  |
| 4 | Cancel checking mode. |  |  |

NOTE:

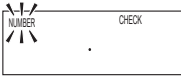
When  is displayed at step 2 or step 3, the memory is not set.

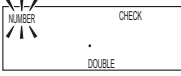
Checking the magnification factor

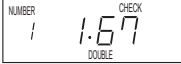
Example : Suppose you want to know the magnification factor for double quantity in memory 1, programmed 1.67.

| Step | Action | Press key | Display |
|------|-------------------------|---|--|
| 1 | Choose checking mode. |  |  |
| 2 | Choose double quantity. |  |  |
| 3 | Choose memory number. |  |  |
| 4 | Cancel checking mode. |  |  |

NOTE:

Magnification factor 1.80 for the double quantity is stored in all memories previously.

MANUAL OPERATION

Your oven can be programmed for up to 3 cooking stages and has 11 preset microwave power levels.

| Cooking Sequence | Microwave power level that can be used | Cooking time that can be used |
|------------------|--|---|
| 1 Stage only | 0-40 % | Max. 30 minutes |
| | 50-100 % | Max. 15 minutes |
| 2 or 3 Stages | 0-40 % | Max. 30 minutes any stage. Max. 30 minutes in total. |
| | 50-100 % | Max. 15 minutes any stage. Max. 15 minutes in total. |

NOTE:

If the time you set exceeds a maximum time, the display will show "EE 9". Touch STOP/CLEAR key () and enter appropriate time.

This model has 11 power levels. Use correct number pad after touching SELECT POWER key ().

| Microwave Power level | 100% | 90% | 80% | 70% | 60% | 50% | 40% | 30% | 20% | 10% | 0% |
|-----------------------|------|-----|-----|-----|-----|-----|-----|-----|-----|-----|----|
| Number keys | — | 9 | 8 | 7 | 6 | 5 | 4 | 3 | 2 | 1 | 0 |

TIME COOKING

Example : Suppose you want to cook for 2 minutes and 30 seconds at 50 %.



Choose the manual cooking. Enter desired cooking time. Touch SELECT POWER key.



Choose desired power level. Start to cook. Check the display.

NOTE:

1. It is not necessary to touch SELECT POWER key () for 100 %.
2. During the cooking, the oven will stop when the door is opened. To restart the cooking, close the door and press the START key (). If the START key () is not touched within 1 minute after closing the door, the programme will be cancelled.
3. If the time you set exceeds a maximum time, the display will show "EE 9".
Touch STOP/CLEAR key () and enter appropriate time.

MULTIPLE SEQUENCE COOKING

Example : Suppose you want to cook for 5 minutes at 70 % and then continue to cook for 20 minutes at 30 %.



Choose the manual cooking. Enter desired cooking time for the 1st stage. Touch SELECT POWER key.



Choose desired power level for the 1st stage. Touch MANUAL/REPEAT key. Enter desired cooking time for the 2nd stage.



Touch SELECT POWER key. Enter desired power level for the 2nd stage. Start to cook. Check the display.

NOTE:

1. It is not necessary to touch SELECT POWER key () for 100 %.
2. When you press START pad, the display will show the total cooking time.
3. During cooking mode, the oven stops when the door is opened, and the programme is canceled if the START key () is not touched within 1 minute after the door is closed.
4. If the time you set exceeds a maximum time, the display will show "EE 9".
Touch STOP/CLEAR key () and enter appropriate time.

REPEAT COOK

Your oven can remember the last manual programme.







Example : Suppose you want to cook with the last programme, which is programmed for 2 minutes and 30 seconds at 50 %.

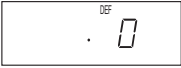

Choose the repeat cook. Check the last programme. Start to cook. Check the display.

EXPRESS DEFROST

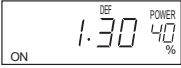
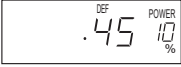
Use the EXPRESS DEFROST key to defrost faster and better different types of food. Enter desired defrost time, referring to the EXPRESS DEFROST CHART on pages EN-13 and EN-14. Example : If you want to defrost for 1 minutes and 30 seconds.

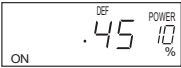
| Step | Action | Press Key | Display |
|------|---|---|---|
| 1 | Press the EXPRESS DEFROST key. |  |  |
| 2 | Enter desired defrost time. |  |  |
| 3 | Press the START key. |  |  |
| 4 | Halfway through defrost time, open the door. Turn food over and shield any warm portions. Close the door. (CHECK will flash and audible signal will sound 4 times.) | |  |
| 5 | Press the START key within 1 minute after closing the door. |  |  |

- Note: 1. If you do not open the door at step 4, the defrosting cycle will continue and the defrosting time will count down to 0.
 2. If the time you set exceeds a maximum time (30 min.), the display will show "EE 9". Touch STOP/CLEAR key () and enter appropriate time.

EXPRESS DEFROST CHART

This is specially designed for smaller cuts of food. The following foods should be used on the express defrost programme.

1. Beef Steak
2. Lamb Chops
3. Pork Chops
4. Chicken Portions
5. Fish Steaks

The oven is pre-programmed with a time and power level cycle so that the food listed above is defrosted easily.

BASIC IDEAS FOR EXPRESS DEFROST

- Always allow food to stand for approx. 10-30 minutes after defrosting to equalise the temperature and to produce better defrosting results.
- Check food after standing. If the item is not thoroughly defrosted, continue to defrost on 20% power for additional time.
- Choose foods that are the same thickness throughout. This will produce better defrosting results. Foods which vary in thickness may require shielding with small flat pieces of tin foil to prevent over-defrosting.
- For foods not listed in the chart refer to the manual defrosting chart.
- When freezing chicken pieces, steak, chops and fish, freeze separately in single flat layers and if necessary interleave with freezer plastic to separate layers. This will ensure even defrosting.









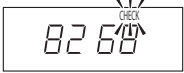

| FOOD | Init. Temp. | 200 g | 400 g | 600 g | METHOD |
|--|-------------|------------------|---------------|---------------|---|
| Steak Pork, lamb chops Chicken Portions Fish Steaks | -18°C | 1'30" - 1'50" | approx. 3' | 4' - 4'30" | <ol style="list-style-type: none"> 1. Position the food with thinner parts in centre in a single layer, if pieces are stuck together separate as soon as possible. 2. Shield any thinner parts with foil if necessary. 3. Turn over, rearrange after the audible sound. After turning over, shield the defrosted portions with small, flat pieces of aluminium foil. After defrosting stand for 10-30 minutes. |

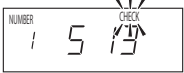
OTHER CONVENIENT FUNCTIONS

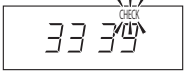
COUNTER CHECK

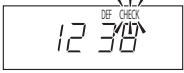
The number of times when the oven will be used are automatically accumulated for each key. You can check how many times the oven was used.

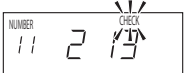
Example : Suppose you want to know total using time, times of using each memory and times of manual cooking. In this case the oven was used 8268 times, the memory 1 was used 513 times, manual cooking was used 3339 times, DEFROST was used 1238 and the memory 11 was used 213 times.

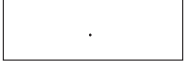
| Step | Action | Press Key | Display |
|------|---------------------------------------|---|--|
| 1 | Choose checking mode. |  x 2 |  CHECK will flash on and off. (Total count) |
| 2 | Check times of using the memory 1. |  |  (Times memory 1 used) |
| | Check times of using manual cooking. |  |  (Times manual cooking used) |
| | Check times of using EXPRESS DEFROST. |  |  (DEFROST count) |
| | Check times of using the memory 11. |  x 2 |  |
| 3 | Complete checking. |  |  |







NOTE:

Each counter can count the times up to 9999, and then it will return to 0.

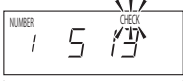

COUNTER RESET

Each number of times can be cleared.

Example : Suppose you want to clear the times of memory 1.

| Step | Action | Press key | Display |
|------|------------------------------------|---|---|
| 1 | Choose checking mode. |  × 2 |  CHECK will flash on and off. (Total count) |
| 2 | Choose the memory 1. |  |  (Times memory 1 used) |
| 3 | Clear times of using the memory 1. |  |  |
| 4 | Cancel checking mode. |  |  |



NOTE:

- To clear times of manual cooking, touch MANUAL/REPEAT key () at step 2 instead of NUMBER key.
To clear times of Defrost cooking, touch EXPRESS DEFROST key () at step 2 instead of NUMBER key.
- To clear total using times, skip step 2.

INFORMATION WITH ERROR MESSAGES

If ERROR messages are displayed, follow the below instructions.

ERROR MESSAGES

| | |
|---|--|
| EE1, EE2, EE3, EE6, E10, EE16, EE19 | Please contact your dealer or an authorized Sharp service agent because the oven must be out of order. |
| EE7 | Exhaust air temperature is too high. Checking that nothing is blocking the ventilation openings or that room temperature is very hot or that oven cavity is empty during operation. Correct, touch STOP/CLEAR key () and try again after a few minutes. |
| EE9 | The time you set exceeds a maximum time. Touch STOP/CLEAR key () and enter appropriate time. |
| EE17 | Magnetron temperature is too high, touch STOP/CLEAR key () and try again after a few minutes. |

INFORMATION WITH FILTER INDICATOR

Clean the air intake filter when the FILTER indicator lights up (See page EN-17). The FILTER indicator will light up when the oven has been operated for about 200 hours in total.

To cancel FILTER indicator touch the START key (). The oven will start to count the operation time automatically again when the FILTER indicator is canceled.

CARE AND CLEANING

CLEAN THE OVEN AT REGULAR INTERVALS AND REMOVE ANY FOOD DEPOSITS - Keep the oven clean, or the oven could lead to deterioration of the surface. This could adversely affect the life of the appliance and possibly result in a hazardous situation.

VERY IMPORTANT CAUTIONS:

- DO NOT OPERATE THE OVEN WITHOUT THE SPLASH COVER IN PLACE.
- DO NOT REMOVE THE SPLASH COVER UNLESS THE POWER CORD IS REMOVED FROM THE OUTLET BECAUSE THE ROTARY ANTENNA, WHICH IS LOCATED ON THE CEILING, OPERATES FOR 1 MINUTE AFTER THE DOOR IS OPENED AND INJURY COULD OCCUR.
- DO NOT USE COMMERCIAL OVEN CLEANERS, ABRASIVE, HARSH CLEANERS OR SCOURING PADS ON ANY PART OF YOUR MICROWAVE OVEN.
- DO NOT SPRINKLE WATER ONTO THE OVEN DIRECTLY. IT MAY CAUSE ELECTRIC SHOCK, LEAKAGE OF ELECTRICITY OR DAMAGE OF THE OVEN.
- THE OVEN SHOULD NOT BE CLEANED WITH A WATER JET.

Oven Exterior

The outside of your oven can be cleaned easily with mild soap and water. Make sure the soap is wiped off with a moist cloth, and dry the exterior with a soft towel.

Control Panel

Open the door before cleaning to inactivate the control panel keys. Care should be taken in cleaning the control panel. Using a cloth dampened with water only, gently wipe the panel until it becomes clean. Avoid the use of excess water. Do not use any sort of chemical or abrasive cleaner. To do so may cause severe damage to the panel and make key entry impossible.

Oven Interior

- 1) For easy cleaning, wipe any spatters or spills with a soft damp cloth or sponge at the end of each day for hygienic reasons. For heavier spills, use mild soap and wipe several times with a damp cloth until all residues are removed. Built-up splashes may overheat and begin to smoke or catch fire, and cause arcing.
- 2) Keep the ceramic floor clean at all times. If you leave grease or fat in the cavity, it may overheat, smoke or even catch fire when next using the oven.

CAUTION:

DO NOT REMOVE THE CERAMIC FLOOR FROM THE OVEN.

- 3) Make sure that mild soap or water does not penetrate through the small vents in the walls which may cause damage to the oven.
- 4) Do not use spray type cleaners on the oven interior.

Splash cover

AT LEAST ONCE A WEEK, REMOVE THE SPLASH COVER AND WASH BOTH SIDES OF IT IN A MILD DETERGENT SOLUTION. BUILT-UP GREASE MAY OVERHEAT AND BEGIN TO SMOKE. AND OVERHEATED GREASE MAY BURN THE SPLASH COVER. THE SPLASH COVER IS LOCATED IN THE TOP OF THE OVEN AND MAY EASILY BE REMOVED. REMEMBER TO UNPLUG THE POWER CORD.

Removal:

1. Remove two thumb screws (A) as shown in Fig. 1.
2. Remove the splash cover from the oven.

Reinstall:

1. Insert two projections of the cover (B) into the holes of the oven cavity backplate as shown in Fig. 2.
2. Secure the cover to the oven ceiling with two thumb screws (A) as shown in Fig. 1.

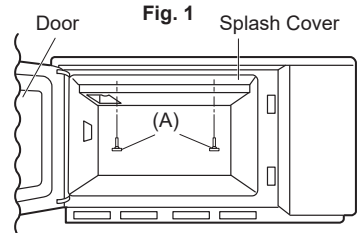

Fig. 1

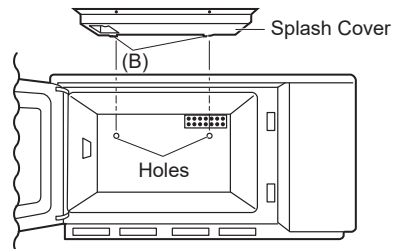

Fig. 2

Oven lamp replacement

Unplug the oven before removing the oven lamp access cover, and replace the lamp (25W/240V). Make sure that the cover is secured to the oven cabinet after replacing the lamp.

Door

To remove all trace of dirt, regularly clean both sides of the door, the door seals and adjacent parts with a soft, damp cloth. Do not use abrasive cleaner.

Air intake filter

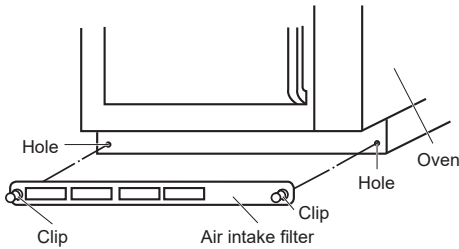

Keep clean the air intake filter. To clean the air intake filter you have to pull the two clips on the filter and to remove the air intake filter. Wash the air intake filter in mild soapy water and dry with a soft cloth. After cleaning re-install the air intake filter to the oven. Clean the air intake filter once every two weeks.

CAUTION:
DO NOT OPERATE THE OVEN WITHOUT THE AIR INTAKE FILTER IN PLACE.

SERVICE CALL CHECK

Please check the following before calling for service.

1. Power Supply
Check the power plug is properly connected to a suitable wall outlet.
Check the line fuse/circuit breaker is functioning properly.
2. When the door is opened:
A. Does the oven lamp light?
B. Does the cooling fan work?
(Put your hand over the rear ventilation opening.)
3. Place one cup of 150 ml water in the oven and close the door securely.
Touch these keys.



- A. Does the cook indicator go on? YES _____ NO _____
B. At the end of this time, is the water warm? YES _____ NO _____

If "NO" is the answer to any of the above questions, call your dealer or an authorized SHARP Service Agent and report the results of your check.

GUIDE

USEFUL THINGS TO KNOW ABOUT MICROWAVES

Microwaves set the water molecules contained in the food vibrating. The resulting friction generates heat that can be used to defrost or cook the food.

Food



The microwaves are absorbed by the food

SUITABLE UTENSILS

Glass, Glass-ceramics and Porcelain

Heat-resistant utensils made of glass, glass-ceramic or porcelain are suitable. However, the utensils must not contain metals (e.g., lead crystal) or be metal-plated (e.g., gold rim, cobalt blue).

Glass, Porcelain, Ceramics Plastics, paper etc.



Microwaves pass through

Ceramics

are usually suitable but they must be enamelled. When using utensils that are not enamelled, moisture can be absorbed by the material and heat it up. This can cause the material to crack.

Plastics and Paper Dishes

Heat-resistant and microwave-proof plastic utensils or paper dishes are suitable for defrosting, heating and cooking. Please follow the manufacturer's instructions.

Microwave Plastic Wrap

or heat-resistant wrap is suitable for covering and wrapping food. Please follow the manufacturer's instructions.

Roasting Bags

can be used in microwave ovens. Do not close the bags with a metal clip because the clip may cause the bag film to melt. Close the bag with string and pierce it several times with a fork. Films that are not heat-resistant, e.g., films to retain product freshness are not recommended for use in microwave ovens.

Metals

should not, as a rule, be used in microwave ovens because microwaves cannot penetrate metals and reach the food inside.

There are, however, some exceptions: Small strips of aluminum foil can be used to cover parts to prevent them from defrosting or cooking too fast (e.g., chicken wings).

Metal

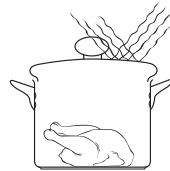

Microwaves are reflected

Small metal skewers and aluminum trays (of prepackaged food) may be used. However, they must be small in proportion to the food. Aluminum containers, for example, must be filled to at least 2/3 to 3/4 with food.

It is recommendable to transfer the food into microwavesafe containers.

When using aluminum trays or other metal utensils, they must be placed at least 2.0 cm away from the cavity walls. Otherwise the cavity walls may be damaged by sparking.

Do not use any utensils with metal-plating, metal parts or metal projections like screws, ribbons, or handles.

TESTING UTENSILS

Perform the following test if you are unsure whether a certain utensil is microwave-safe: Place the utensil into the oven, put a glass containing about 150 ml of water on or beside the utensil, and operate the microwave oven at 100% power for 1 to 2 minutes. If it is cool or luke-warm to the touch, the utensil is suitable for microwave use. Do not perform this test on plastic dishes because the plastic might melt.

INFORMATION ABOUT POWER LEVEL

100%-70% power:

The high power is perfect for warming up or regenerating food. You can also use it to make food boil e.g. water and then cook further with lower power. (e.g. for rice or noodles)

60%-40% power:

For longer cooking times and compact types of food.

30%-20% power:

For considerate cooking and sensitive menus. Also after cooking to simmer or for noodles and rice.

10% power:

The low power level is mainly for defrosting. You can also use it for cooking of very sensitive menus like cheese sauce. Basically it is recommendable to cover the food for cooking or reheating. Additionally you can sprinkle some water over the food (you can also use salted water or even bouillon).

The water steam keeps the food moist and it also helps to make the cooking faster.

COOKING CHART AND RECIPES

| | Menu | Init. Temp. | Microwave Power Levels | 200g | 400g | 600g | Comment |
|-------------|----------------------------|-------------|------------------------|-----------------|---------------|---------------|---|
| DEFROST | Meat | -18°C | 10% | approx. 4' | approx. 5'50" | approx. 8'30" | Turn over at 1/2 of total defrosting time. Standing time about 10 mins. |
| | Poultry | -18°C | 10% | approx. 4'20" | approx. 6'30" | approx. 9'30" | |
| | Fish | -18°C | 10% | approx. 4' | approx. 5'30" | approx. 7'30" | |
| | Fruit | -18°C | 10% | approx. 2'50" | approx. 5'20" | — | |
| | *Cake (no fruit or cheese) | -18°C | 10% | approx. 1' | approx. 1'40" | approx. 2' | |
| | *Cream cake | -18°C | 10% | approx. 1'25" | approx. 2'10" | — | |
| | Shrimps | -18°C | 10% | approx. 4' | approx. 6'30" | approx. 9' | |
| **Cold meat | -18°C | 10% | approx. 3' | approx. 5'30" | approx. 8' | | |
| REHEAT | Soup, clear | 5±2°C | 100% | approx. 50 sec. | approx. 1'30" | approx. 2'20" | Cover with microwave foil or lid. Stir well after reheating. |
| | Soup, cream | 5±2°C | 100% | approx. 1' | approx. 1'40" | approx. 2'40" | |
| | Casseroles | 5±2°C | 100% | approx. 1' | approx. 1'40" | approx. 2'40" | |
| | Supplements, Noodles | 5±2°C | 100% | approx. 40 sec. | approx. 1'10" | approx. 2' | |
| | Supplements, Rice | 5±2°C | 100% | approx. 40 sec. | approx. 1'20" | approx. 2' | |
| | Supplements, Potatoes | 5±2°C | 100% | approx. 40 sec. | approx. 1'30" | approx. 2'10" | |
| | Supplements, Vegetables | 5±2°C | 100% | approx. 50 sec. | approx. 1'30" | approx. 2'10" | |
| | Baked Beans | 5±2°C | 100% | approx. 55 sec. | approx. 1'50" | — | |
| | Goulash, Ragout | 5±2°C | 100% | approx. 1' | approx. 2' | approx. 2'50" | |
| | *Meat (150g) | 5±2°C | 100% | approx. 40 sec. | approx. 1'20" | — | |
| | *Sausages (50g) | 5±2°C | 100% | approx. 15 sec. | 25 sec. | 40 sec. | |
| COOK | Supplements, Potatoes | 20±2°C | 100% | approx. 2' | approx. 3'30" | approx. 5' | Use casserole lid. Stir at 1/2 of total cooking time. |
| | Supplements, Vegetables | 20±2°C | 100% | approx. 2'10" | approx. 3'50" | approx. 5'20" | |

*indications per pcs. (1,2,3 pcs.) not in gram.

**Remove defrosted portions. Standing time about 10 mins.

| | Menu | Int. Temp. | Microwave Power Levels | 1 pc | 2 pcs |
|----------|--------------------------------|------------|------------------------|-----------------|-----------------|
| SPECIALS | Danish Pastrys | 20±2°C | 100% | approx. 6 sec. | — |
| | *Doughnuts/Berliner | 20±2°C | 100% | approx. 5 sec. | approx. 8 sec. |
| | *Boucheés à la reine | 20±2°C | 100% | approx. 10 sec. | approx. 15 sec. |
| | *Burger | 5±2°C | 100% | 35 sec. | 1'10" |
| | *Cheeseburger | 5±2°C | 50% | 50 sec. | 1'40" |
| | Toast and Bacon(140g) | 20±2°C | 100% | 10 sec. | — |
| | Scrambled Eggs and Bacon(140g) | 5±2°C | 100% | 40 sec. | — |

*indications per pcs. (1,2,3 pcs.) not in gram.

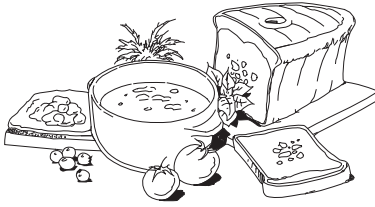

Omelette

Sprinkle a normal plate with fat. Beat three eggs with some salt and pepper. Pour the eggs on the plate and cook for approx. 45 sec. Add any filling (2 tbsp.) you want (ragout, vegetables) and cook again for approx.10 sec.



Scrambled Eggs

Mix two eggs with salt, pepper and some milk. Cook for approx. 45 sec., three times stirring within total cooking time.



Bacon

Place 2 thin slices of bacon between paper towels and cook approx. 15 sec.



Toast Hawaii

Prepare toasts and spread with butter. Place one slice of ham, pineapple and cheeses on a plate and cook for approx. 20 sec. After cooking place on the prepared toast.



Hot chocolate with cream

Pour 150 ml milk in a big cup. Add 30 g black chocolate (sliced). Stir and cook for 40 sec. Stir again once in between. Add some stirred cream and serve with some chocolate powder on top.



SPECIFICATIONS

| | |
|--|--|
| AC Line Voltage | 230V, 50Hz, single phase |
| Distribution line fuse/circuit breaker | 16A (time lag) |
| AC Power Required | 3.15 kW |
| Output Power | 2100W (IEC 60705) |
| Microwave Frequency | 2450MHz *(Group 2/Class B) |
| Sound level | less than 70dB (A) |
| Outside Dimensions | 510 mm(W) x 335 mm(H) x 470 mm(D) (Single oven) 510 mm(W) x 670 mm(H) x 470 mm(D) (Two ovens) |
| Cavity Dimensions | 330 mm(W) x 180 mm(H) x 330 mm(D) |
| Oven Capacity | 20 litres |
| Cooking Uniformity | Rotary antenna system |
| Weight | Approx. 33 kg |

This product contains a light source of energy efficiency class G.

* This Product fulfils the requirement of the European standard EN55011. In conformity with this standard, this product is classified as group 2 class B equipment. Group 2 means that the equipment intentionally generates radio-frequency energy in the form of electromagnetic radiation for heating treatment of food. Class B equipment means that the equipment suitable to be used in domestic establishments.

(This product is designed for commercial application only and as such it falls outside the scope of Regulation (EC) 1275/2008 implementing EU Directive 2005/32/EC on eco-design requirements for standby and off mode electric power consumption. Sharp do not recommend the product for domestic application and will not accept any liability for such use.)



External equipotential bonding terminal

This appliance has an external equipotential bonding terminal, and this symbol is on the back of the microwave oven.

As part of a policy of continuous improvement, we reserve the right to alter design and specification without notice.

NOTE

| | | |
|-----------|----------------------------|---|
| EN | Manufacturer: | SHARP Corporation 1 Takumi-cho, Sakai-ku, Sakai-shi, Osaka 590-8522, Japan |
| | Authorised Representative: | SHARP Electronics GmbH, Nagelsweg 33 - 35, 20097 Hamburg, Germany |



SDA/MAN/0301 V2

www.sharpconsumer.eu

SHARP

TINSZA339WRRZ-H31