



Dell S2425H/S2725H Monitor

User's Guide

Model: S2425H/S2725H
Regulatory model: S2425Ht/S2725Ht



-  **NOTE:** A NOTE indicates important information that helps you make better use of your product.
-  **CAUTION:** A CAUTION indicates either potential damage to hardware or loss of data and tells you how to avoid the problem.
-  **WARNING:** A WARNING indicates a potential for property damage, personal injury, or death.

Copyright © 2024 Dell Inc. or its subsidiaries. All rights reserved. Dell, EMC, and other trademarks are trademarks of Dell Inc. or its subsidiaries. Other trademarks may be trademarks of their respective owners.

2024 – 03

Rev. A00

Contents

Safety instructions	5
About your monitor	6
Package contents	6
Product features	8
Operating system compatibility	11
Identifying parts and controls	12
Front view	12
Back view	13
Side view.	14
Bottom view	14
Monitor specifications	16
Resolution specifications	19
Supported video modes	19
Preset display modes	19
Electrical specifications.	20
Physical characteristics.	21
Environmental characteristics	22
Pin assignments	23
Plug-and-play capability	24
LCD monitor quality and pixel policy	24
Ergonomics	24
Handling and moving your display	26
Maintenance guidelines	28
Cleaning your monitor.	28





- Setting up the monitor 29**
 - Attaching the stand 29
 - Using the tilt 32
 - Connecting your monitor 33
 - Attaching the side I/O-cover 34
 - Organizing your cables 34
 - Securing your monitor using Kensington lock (optional) 35
 - Removing the monitor stand 36
 - VESA wall mounting (optional) 37
- Operating the monitor 38**
 - Power on the monitor 38
 - Using the joystick control 38
 - Using the rear-panel controls 40
 - Front-panel button 42
 - Using the Main Menu 43
 - Using the OSD lock function 55
 - OSD warning messages 58
 - Setting the maximum resolution 60
- Troubleshooting 61**
 - Self-test 61
 - Built-in diagnostics 62
 - Common problems 63
- Regulatory information 66**
 - FCC notices (U.S. only) and other regulatory information 66
 - EU product database for energy label and product information sheet 66
- Contacting Dell. 67**



Safety instructions

Use the following safety guidelines to protect your monitor from potential damage and to ensure your personal safety. Unless otherwise noted, each procedure included in this document assumes that you have read the safety information that shipped with your monitor.

 **NOTE: Before using the monitor, read the safety information that is shipped with your monitor and printed on the product. Keep the documentation at a secure location for future reference.**

 **WARNING: Use of controls, adjustments, or procedures other than those specified in this documentation may result in exposure to shock, electrical hazards, and/or mechanical hazards.**

 **WARNING: The possible long-term effect of listening to audio at high volume through the headphones (on monitor that support it) may cause damage to your hearing ability.**

- Place the monitor on a solid surface and handle it carefully. The screen is fragile and can be damaged if dropped or hit with a sharp object.
- Ensure that your monitor is electrically rated to operate with the AC power available in your location.
- Keep the monitor in room temperature. Excessive cold or hot conditions can have an adverse effect on the liquid crystals of the display.
- Connect the power cable from the monitor to a wall outlet that is near and accessible. See [Connecting your monitor](#).
- Do not place and use the monitor on a wet surface or near water.
- Do not subject the monitor to severe vibration or high impact conditions. For example, do not place the monitor inside a car trunk.
- Unplug the monitor when it is going to be left unused for an extended period.
- To avoid electric shock, do not attempt to remove any cover or touch the inside of the monitor.
- Read these instructions carefully. Keep this document for future reference. Follow all warnings and instructions marked on the product.
- Certain monitors can be wall mounted using the VESA mount that is sold separately. Ensure to use the correct VESA specifications as mentioned in the wall mounting section of the User's Guide.

For information about safety instructions, see the Safety, Environmental, and Regulatory Information (SERI) document that is shipped with your monitor.







About your monitor





Package contents

The following table provides the list of components that are shipped with your monitor. If any component is missing, contact Dell. For more information, see [Contacting Dell](#).

NOTE: Some items may be optional and may not ship with your monitor. Some features may not be available in certain countries.

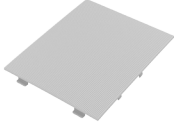
Component image	Component description
	Display
	Stand riser
	Stand base
	Side I/O-cover



	VESA cover
	Power cable (varies by country)
	HDMI cable 1.80m
	<ul style="list-style-type: none">• Quick Start Guide• Safety, Environmental, and Regulatory Information



Product features

The Dell **S2425H/S2725H** monitor has an active matrix, Thin Film Transistor (TFT), Liquid Crystal Display (LCD), and LED backlight. The monitor has the following features:

- Supports the refresh rate of 100 Hz.
- Color gamut of 99% sRGB (typical).
- Digital connectivity with 2 HDMI ports.
- Plug and play capability if supported by your computer.
- Integrated speakers (2 x 5W).
- On-Screen Display (OSD) adjustments for ease of setup and screen optimization.
- Removable stand and 100 mm Video Electronics Standards Association (VESA) mounting holes for flexible mounting solutions.
- Tilt only.
- Security-lock slot for Kensington locks (sold separately).
- Offers Premium Panel Exchange during warranty period.
- Supports Dell ComfortView Plus feature.
- Dell ComfortView Plus is an integrated low blue light screen feature that improves eye comfort by reducing potentially harmful blue light emissions without compromising color. Through ComfortView Plus technology, Dell has reduced harmful blue light exposure from $\leq 50\%$ to $\leq 35\%$. This monitor is certified with TÜV Rheinland Eye Comfort 3.0 with a 4-star rating. It incorporates key technologies that also deliver a flicker-free screen, up to 100 Hz refresh rate, and a color gamut of minimum 95% sRGB. Dell ComfortView Plus feature is enabled by default on your monitor.
- This monitor uses a low blue light panel. When the monitor is reset to factory settings or default setting, it is in compliance with TÜV Rheinland's hardware low blue light certification.*

Blue light ratio:

The ratio of light in the range from 415nm-455nm compared to 400nm-500nm shall be less than 50%.

Category	Blue light ratio
1	$\leq 20\%$
2	$20\% < R \leq 35\%$
3	$35\% < R \leq 50\%$

- Decreases the level of hazard blue light emitted from the screen to make viewing more comfortable for your eyes without distortion of color accuracy.



- The monitor adopts Flicker-Free technology, which clears the eye visible flicker, brings comfort viewing experience and preventing users suffer from eye strain and fatigue.
- * This monitor is in compliance with TÜV Rheinland hardware low blue light certification under Category 2.

About TÜV Rheinland Eye Comfort 3.0

TÜV Rheinland Eye Comfort 3.0 certification program presents a consumer-friendly star rating scheme to the display industry promoting eye wellness from safety to eye care. Compared to existing certifications, the 5-star-rating program adds rigorous testing requirements on overall eye care attributes such as low blue-light, flicker-free, refresh rate, color gamut, color accuracy and ambient light sensor performance. It lays out requirement metrics and rates the product performance on five levels, and the sophisticated technical assessment process provides consumers and buyers with indicators that are easier to judge.

The eye wellness factors being considered remain constant, however, the standards for the various star ratings are different. The higher the star rating, the more stringent the standards. The table below lists the major eye comfort requirements which apply in addition to the basic eye comfort requirements (such as pixel density, uniformity of luminance and color, and freedom of movement).

For more information around **TUV Eye Comfort certification** please refer to: <https://www.tuv.com/world/en/eye-comfort.html>.



Eye Comfort 3.0 Requirements and Star Rating Scheme for Monitors

Category	Test item	Star Rating Scheme		
		3-star	4-star	5-star
Eye Care	Low Blue Light	TÜV Hardware LBL Category III ($\leq 50\%$) or Software LBL solution ¹	TÜV Hardware LBL Category II ($\leq 35\%$) or Category I ($\leq 20\%$)	TÜV Hardware LBL Category II ($\leq 35\%$) or Category I ($\leq 20\%$)
	Flicker Free	TÜV Flicker Reduced or TÜV Flicker Free	TÜV Flicker Reduced or TÜV Flicker Free	Flicker Free
Ambient Light Management	Ambient Light Sensor performance	No sensor	No sensor	Ambient light sensor
	Intelligent CCT control	No	No	Yes
	Intelligent Luminance control	No	No	Yes
Image quality	Refresh Rate	$\geq 60\text{Hz}$	$\geq 75\text{Hz}$	$\geq 120\text{Hz}$
	Luminance uniformity	Luminance uniformity $\geq 75\%$		
	Color Uniformity	Color uniformity $\Delta u'v' \leq 0.02$		
	Freedom of movement	Luminance changes shall decrease less than 50%; The colour shift shall be less than 0.01		
	Gamma difference	Gamma difference $\leq \pm 0.2$	Gamma difference $\leq \pm 0.2$	Gamma difference $\leq \pm 0.2$
	Wide color gamut ²	NTSC ³ Min.72% (CIE 1931) or sRGB ⁴ Min 95% (CIE 1931)	sRGB ⁴ Min.95% (CIE 1931)	DCI-P3 ⁵ Min. 95% (CIE 1976) & sRGB ⁴ Min.95% (CIE 1931) or Adobe RGB ⁶ Min.95% (CIE 1931) & sRGB ⁴ Min.95% (CIE 1931)
Eye Comfort User Guide	User guide	Yes	Yes	Yes
Remark	<p>¹ Software controls the blue light emission by reducing excessive blue light, resulting in a more yellow tone.</p> <p>² Color gamut describes the availability of colors in the display. Various standards were developed for specific purposes. 100% corresponds to the full color space as defined in the standard.</p> <p>³ NTSC stands for National Television Standards Committee, which developed a color space for the television system that is used in the United States.</p> <p>⁴ sRGB is a standard red, green, and blue color space that is in use on monitors, printers, and the World Wide Web.</p> <p>⁵ DCI-P3, short for Digital Cinema Initiatives - Protocol 3, is a color space used in digital cinema that encompasses a wider range of colors than the standard RGB color space.</p> <p>⁶ Adobe RGB is a color space created by Adobe Systems that encompasses a broader range of colors than the standard RGB color model, particularly in the cyans and greens.</p>			



Operating system compatibility

- Windows 10 and later*

* The operating system compatibility on Dell and Alienware branded monitors may vary based on factors such as:

- Specific release date(s) when operating system versions, patches, or updates are available.
- Specific release date(s) when Dell and Alienware branded monitor firmware, software application, or driver updates are available on the Dell support website.



Identifying parts and controls

Front view

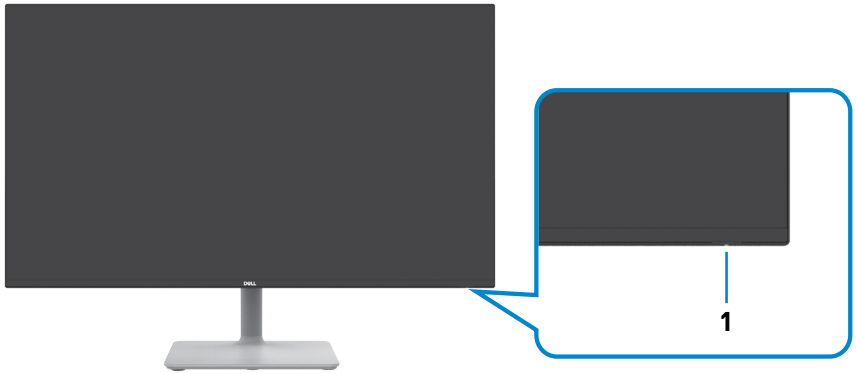

Label	Description	Use
1	Power LED indicator	Solid white indicates that the monitor is turned on and functioning normally. Breathing white indicates that the monitor is in Standby Mode.



Back view

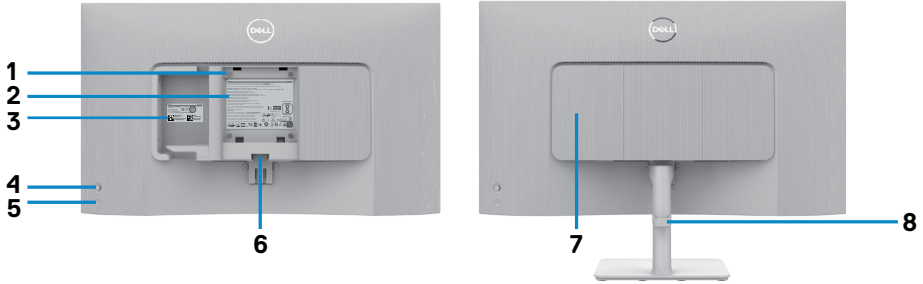

Label	Description	Use
1	VESA mounting holes (100 mm x 100 mm-behind attached VESA cover)	Wall mount monitor using VESA-compatible wall mount kit. NOTE: Wall-mount kit is not shipped with your monitor and is sold separately.
2	Regulatory information label	Lists the regulatory approvals.
3	Regulatory label (including barcode, serial number and Service Tag label)	See this label if you need to contact Dell for technical support. The Service Tag is a unique alphanumeric identifier that enables Dell service technicians to identify the hardware components in your display and access warranty information.
4	Joystick	Use to control the OSD menu. For more information, see Operating the monitor .
5	Power On/Off button	Press the power button to turn the monitor on and off.
6	Stand release button	Releases the stand from the monitor.
7	Side I/O cover	Use to cover side I/O.
8	Cable management guide	Use to organize cables by routing them through the guide.



Side view

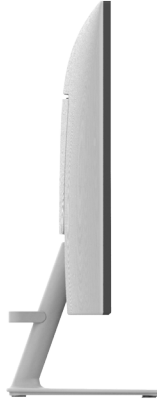

Bottom view

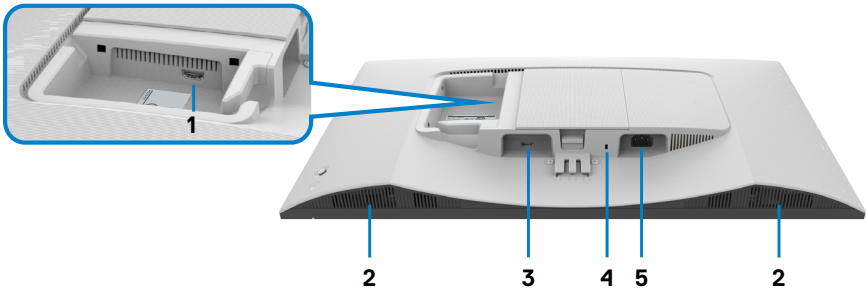

Label	Description	Use
1	HDMI 2 port	Connect to your computer or external device using a HDMI cable (shipped with your monitor).
2	Built-in speakers(2)	Provides audio output.
3	HDMI 1 port	Connect to your computer or external device using a HDMI cable (shipped with your monitor).
4	Security lock slot (based on Kensington Security Slot)	Secure your monitor using a security lock (purchased separately) to prevent unauthorized movement of your monitor.
5	Power connector	Connect the power cable (shipped with your monitor).



NOTE: Hold the end of the cable connector when inserting and removing HDMI cable to avoid any accidental damage.

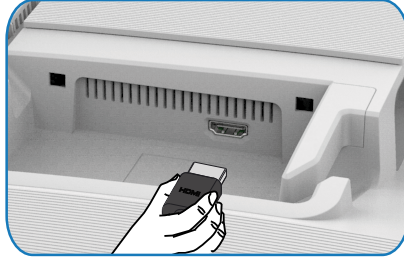

Monitor specifications

Model	S2425H	S2725H
Screen type	Active matrix - TFT LCD	
Panel type	In-Plane Switching(IPS) technology	
Aspect ratio	16:9	
Viewable image dimensions:		
Diagonal	604.70 mm (23.8 in.)	685.99 mm (27.0 in.)
Active Area:		
Horizontal	527.04 mm (20.75 in.)	597.89 mm (23.54 in.)
Vertical	296.46 mm (11.67 in.)	336.31 mm (13.24 in.)
Area	156246.28 mm ² (242.18 in. ²)	201076.91 mm ² (311.67 in. ²)
Pixel pitch	0.2745 mm x 0.2745 mm	0.3114 mm x 0.3114 mm
Pixel per inch (PPI)	93	82
Viewing angle:		
Horizontal	178° (typical)	
Vertical	178° (typical)	
Brightness	250 cd/m ² (typical)	300 cd/m ² (typical)
Contrast ratio	1500 to 1 (typical)	
Display screen coating	Anti-glare treatment of the front polarizer (3H) hard coating	
Backlight	LED edgelight system	
Response time	8 ms (Normal mode) 5 ms (Fast mode) 4 ms (Extreme mode*) * Reduced visible motion blur and increased image responsiveness.	
	 NOTE: Using Extreme mode might introduce minor and noticeable visual artifacts in the image. You can choose Normal or Fast mode to mitigate these visual artifacts.	
Color depth	16.78 million colors	
Color gamut	sRGB Typ. 99%(CIE 1931)	
Connectivity	2 x HDMI port version 1.4 (HDCP 1.4)	
Border width (edge of monitor to active area)		
Top	5.30 mm	5.89 mm
Left/Right	5.30 mm	5.90 mm
Bottom	12.00 mm	12.00 mm



Adjustability:	
Height-adjust	NA
Tilt	-5° to 21°
Swivel	NA
Pivot	NA
Cable management	Yes
Dell Display Manager (DDM) Compatibility*	Easy Arrange and other key features
Security	Security lock slot (cable lock sold separately)
Built-in speakers	2 x 5W



*Dell Display Manager

Dell Display Manager is an application software that enhances the experience of your Dell monitor- ensuring more productivity and ease in customization.

With this application you can:

1. Adjust the monitor On-Screen Display (OSD) settings such as brightness, contrast, input source setting and so on with ease. No need to toggle using the joystick on the monitor; simply use the DDM software.
2. Organize multiple applications on your screen, snapping them into a template of your choice with the Easy Arrange.
3. Assign applications or even files to the partitions of Easy Arrange, save the layout as a profile and then restore the profile automatically using Easy Arrange Memory.
4. Connect your Dell Monitor to multiple input sources and manage these multiple video inputs using Input source.
5. Customize each application with different color mode using Color Preset.
6. Replicate the Dell Display Manager application settings from one monitor to another monitor of the same model with Import/export application settings.

Moreover, this model comes with advanced remote management features for IT admins.

For more information about Dell Display Manager, see <https://www.dell.com/support/ddm>.

You can download the software from this link and find detailed user guide of the software and knowledge base article under the documentation tab.

Dell Display Manager User Interface

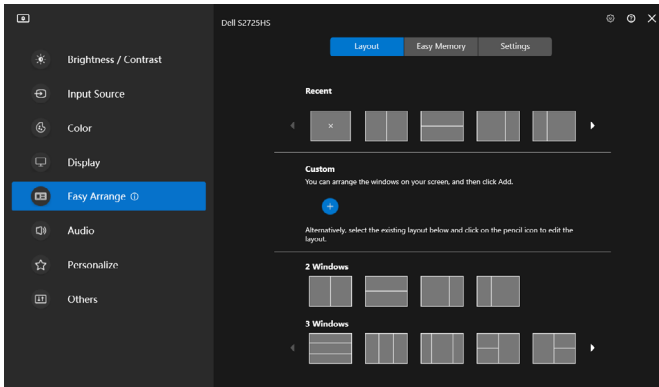

Resolution specifications

Description	Value
Horizontal frequency	30 kHz to 110 kHz
Vertical refresh rate	48 Hz to 100 Hz
Maximum preset resolution	1920 x 1080 at 100 Hz

Supported video modes

Description	Value
Video display capabilities (HDMI playback)	480p, 576p, 720p, 1080i, 1080p

Preset display modes

Display mode	Horizontal frequency (kHz)	Vertical frequency (Hz)	Pixel clock (MHz)	Sync polarity (Horizontal/Vertical)
VGA 720 x 400	31.50	70.00	28.30	-/+
VGA 640 x 480	31.50	60.00	25.20	-/-
VESA 640 x 480	37.50	75.00	31.50	-/-
VESA 800 x 600	37.90	60.00	40.00	+/+
VESA 800 x 600	46.90	75.00	49.50	+/+
VESA 1024 x 768	48.40	60.00	65.00	-/-
VESA 1024 x 768	60.00	75.00	78.80	+/+
MAC 1152 x 864	67.50	75.00	108.00	+/+
VESA 1280 x 1024	64.00	60.00	108.00	+/+
VESA 1280 x 1024	80.00	75.00	135.00	+/+
VESA 1600 x 900	60.00	60.00	108.00	+/+
CVT 1920 x 1080	67.50	60.00	148.50	+/+
CVT 1920 x 1080	110.00	100.00	228.80	+/-



Electrical specifications

Description	Value
Video input signals	<ul style="list-style-type: none"> · Digital video signal for each differential line per differential line at 100 ohm impedance · HDMI signal input support
Input voltage/frequency/current	100 VAC to 240 VAC/50 Hz or 60 Hz \pm 3 Hz/1.5 A (maximum)
Inrush current	120 V: 40 A (maximum) 240 V: 80 A (maximum)
Power Consumption	
S2425H	S2725H
0.3 W (Off Mode) ¹	0.3 W (Off Mode) ¹
0.4 W (Standby Mode) ¹	0.4 W (Standby Mode) ¹
14.5 W (On Mode) ¹	17.0 W (On Mode) ¹
42 W (Max) ²	45 W (Max) ²
13.0 W (P _{on}) ³	15.0 W (P _{on}) ³
41.1 kWh (TEC) ³	47.0 kWh (TEC) ³

¹ As defined in EU 2019/2021 and EU 2019/2013.

² Max brightness and contrast setting.

³ P_{on}: Power consumption of On Mode as defined in Energy Star 8.0 version.

TEC: Total energy consumption in kWh as defined in Energy Star 8.0 version.

This document is informational only and reflects laboratory performance. Your product may perform differently, depending on the software, components and peripherals you ordered and shall have no obligation to update such information. So the customer should not rely upon this information in making decisions about electrical tolerances or otherwise. No warranty as to accuracy or completeness is expressed or implied.

 **NOTE:** This monitor is **ENERGY STAR** certified.



This product qualifies for ENERGY STAR in the factory default settings which can be restored by “Factory Reset” function in the OSD menu. Changing the factory default settings or enabling other features may increase power consumption that could exceed the ENERGY STAR specified limit.



Physical characteristics

Model	S2425H	S2725H
Dimensions (with stand):		
Height	411.73 mm (16.21 in.)	452.21 mm (17.80 in.)
Width	537.64 mm (21.17 in.)	609.69 mm (24.00 in.)
Depth	163.00 mm (6.42 in.)	176.50 mm (6.95 in.)
Dimensions (without stand):		
Height	313.73 mm (12.35 in.)	354.21 mm (13.95 in.)
Width	537.64 mm (21.17 in.)	609.69 mm (24.00 in.)
Depth	58.89 mm (2.32 in.)	59.04 mm (2.32 in.)
Stand dimensions:		
Height	173.82 mm (6.84 in.)	193.75 mm (7.63 in.)
Width	195.00 mm (7.68 in.)	211.20 mm (8.32 in.)
Depth	163.00 mm (6.42 in.)	176.50 mm (6.95 in.)
Base	195.00 mm x 163.00 mm (7.68 in. x 6.42 in.)	211.20 mm x 176.50 mm (8.32 in. x 6.95 in.)
Weight:		
Weight with packaging	5.92 kg (13.05 lb)	7.31 kg (16.11 lb)
Weight with stand assembly and cables	4.04 kg (8.91 lb)	5.19 kg (11.44 lb)
Weight without stand assembly (For wall mount or VESA mount considerations - no cables)	3.29 kg (7.25 lb)	4.30 kg (9.48 lb)
Weight of stand assembly	0.56 kg (1.23 lb)	0.64 kg (1.41 lb)



Environmental characteristics

Description	Value
Compliant Standards:	
<ul style="list-style-type: none">• ENERGY STAR certified Monitor.• RoHS Compliant.• BFR/PVC Reduce monitor (The circuit boards are made from BFR/PVC-free laminates).• Arsenic-Free glass and Mercury-Free for the panel only.	
Temperature:	
Operating	0°C to 40°C (32°F to 104°F)
Non-operating	-20°C to 60°C (-4°F to 140°F)
Humidity:	
Operating	10% to 80% (non-condensing)
Non-operating	5% to 90% (non-condensing)
Altitude:	
Operating (maximum)	5,000 m (16,404 ft)
Non-operating (maximum)	12,192 m (40,000 ft)
Thermal dissipation:	
S2425H	143.3 BTU/hour (maximum) 49.5 BTU/hour (on mode)
S2725H	153.5 BTU/hour (maximum) 58.0 BTU/hour (on mode)



Pin assignments

HDMI port

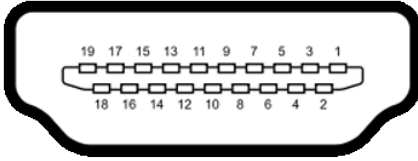

Pin number	19-pin side of the connected signal cable
1	TMDS DATA 2+
2	TMDS DATA 2 SHIELD
3	TMDS DATA 2-
4	TMDS DATA 1+
5	TMDS DATA 1 SHIELD
6	TMDS DATA 1-
7	TMDS DATA 0+
8	TMDS DATA 0 SHIELD
9	TMDS DATA 0-
10	TMDS CLOCK+
11	TMDS CLOCK SHIELD
12	TMDS CLOCK-
13	CEC
14	Reserved (N.C. on device)
15	DDC CLOCK (SCL)
16	DDC DATA (SDA)
17	DDC/CEC Ground
18	+5 V POWER
19	HOT PLUG DETECT



Plug-and-play capability

You can connect the monitor to any Plug-and-Play compatible system. The monitor automatically provides the computer with its Extended Display Identification Data (EDID) using Display Data Channel (DDC) protocols so that the computer can configure itself and optimize the monitor settings. Most monitor installations are automatic; you can select different settings as required. For more information about changing the monitor settings, see [Operating the Monitor](#).

LCD monitor quality and pixel policy

During the LCD Monitor manufacturing process, it is not uncommon for one or more pixels to become fixed in an unchanging state which are hard to see and do not affect the display quality or usability. For more information about Dell Monitor Quality and Pixel Policy, see <https://www.dell.com/pixelguidelines>.

Ergonomics

⚠ CAUTION: Improper or prolonged usage of keyboard may result in injury.

⚠ CAUTION: Viewing the monitor screen for extended periods of time may result in eye strain.

For comfort and efficiency, observe the following guidelines when setting up and using your computer workstation:

- Position your computer so that the monitor and keyboard are directly in front of you as you work. Special shelves are commercially available to help you correctly position your keyboard.
- To reduce the risk of eye strain and neck/arm/back/shoulder pain from using the monitor for long periods of time, we suggest you to:
 1. Set the distance of the screen between 20 to 28 in. (50 - 70 cm) from your eyes.
 2. Blink frequently to moisten your eyes or wet your eyes with water after prolonged usage of the monitor.
 3. Take regular and frequent breaks for 20 minutes every two hours.
 4. Look away from your monitor and gaze at a distant object at 20 feet away for at least 20 seconds during the breaks.
 5. Perform stretches to relieve tension in the neck, arm, back, and shoulders during the breaks.
- Make sure that the monitor screen is at eye level or slightly lower when you are sitting in front of the monitor.
- Adjust the tilt of the monitor, its contrast, and brightness settings.



- Adjust the ambient lighting around you (such as overhead lights, desk lamps, and the curtains or blinds on nearby windows) to minimize reflections and glare on the monitor screen.
- Use a chair that provides good lower-back support.
- Keep your forearms horizontal with your wrists in a neutral, comfortable position while using the keyboard or mouse.
- Always leave space to rest your hands while using the keyboard or mouse.
- Let your upper arms rest naturally on both sides.
- Ensure that your feet are resting flat on the floor.
- When sitting, make sure that the weight of your legs is on your feet and not on the front portion of your seat. Adjust your chair's height or use a footrest if necessary to maintain a proper posture.
- Vary your work activities. Try to organize your work so that you do not have to sit and work for extended periods of time. Try to stand or get up and walk around at regular intervals.
- Keep the area under your desk clear of obstructions and cables or power cords that may interfere with comfortable seating or present a potential trip hazard.

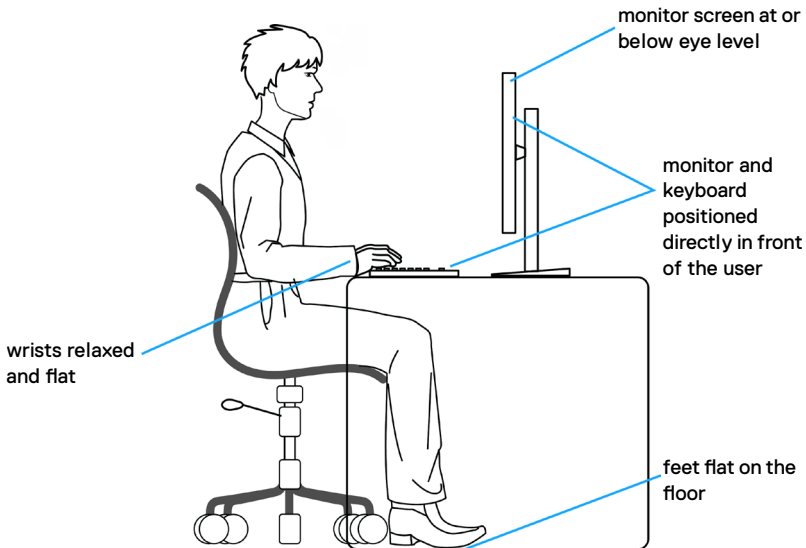

Handling and moving your display

To ensure the monitor is handled safely when lifting or moving it, follow the guidelines mentioned below:

- Before moving or lifting the monitor, turn off your computer and the monitor.
- Disconnect all cables from the monitor.
- Place the monitor in the original box with the original packing materials.
- Hold the bottom edge and the side of the monitor firmly without applying excessive pressure when lifting or moving the monitor.

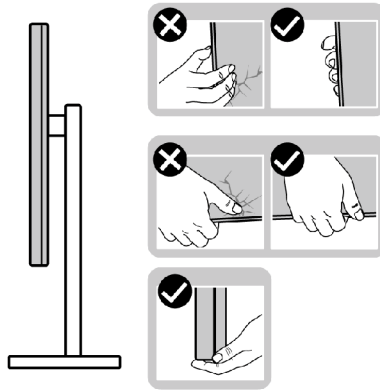

- When lifting or moving the monitor, ensure the screen is facing away from you and do not press on the display area to avoid any scratches or damage.

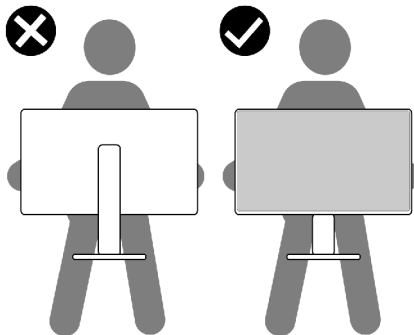

- When transporting the monitor, avoid any sudden shock or vibration to it.



- When lifting or moving the monitor, do not turn the monitor upside down while holding the stand base or stand riser. This may result in accidental damage to the monitor or cause personal injury.

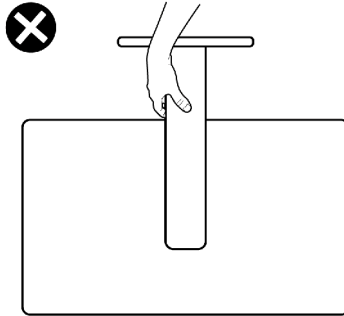

Maintenance guidelines

Cleaning your monitor

 **CAUTION:** Read and follow the [Safety instructions](#) before cleaning the monitor.

 **WARNING:** Before cleaning the monitor, unplug the monitor power cable from the electrical outlet.

For best practices, follow the instructions in the list below when unpacking, cleaning, or handling your monitor:

- Use a clean cloth that is slightly dampened with water to clean the stand assembly, the screen, and the chassis of your Dell monitor. If available, use a screen-cleaning tissue or solution suitable for cleaning Dell monitors.
- After cleaning the surface of the table, ensure that it is thoroughly dry and free from any moisture or cleaning agent before placing your Dell monitor on it.

 **CAUTION:** Do not use detergents or other chemicals such as benzene, thinner, ammonia, abrasive cleaners, alcohol, or compressed air.

 **CAUTION:** Using chemicals for cleaning may cause changes in the appearance of the monitor, such as color fading, milky film on the monitor, deformation, uneven dark shade, and peeling of screen area.

 **WARNING:** Do not spray the cleaning solution or even water directly on the surface of the monitor. Doing so will allow liquids to accumulate at the bottom of the display panel and corrode the electronics resulting in permanent damage. Instead, apply the cleaning solution or water to a soft cloth and then clean the monitor.



 **NOTE:** Monitor damages due to improper cleaning methods and the use of benzene, thinner, ammonia, abrasive cleaners, alcohol, compressed air, detergent of any kind will lead to a Customer Induced Damage (CID). CID is not covered under the standard Dell warranty.

- If you notice white residual powder when you unpack your monitor, wipe it off with a cloth.
- Handle your monitor with care as a darker-colored monitor may get scratched and show white scuff marks more than a lighter-colored monitor.
- To help maintain the best image quality on your monitor, use a dynamically changing screen saver and turn off your monitor when not in use.



Setting up the monitor

Attaching the stand

-  **NOTE:** The stand is not installed at the factory when shipped.
-  **NOTE:** The following instructions are applicable only for the stand that was shipped with your monitor. If you are connecting a stand that you purchased from any other source, follow the setup instructions that were included with the stand.

To attach the monitor stand:

1. Align the tabs on the stand base with the slots on the stand riser.
2. Insert the stand riser on the stand base firmly.
3. Open the screw handle at the bottom of the stand base, and rotate it clockwise to tighten the screw firmly. Close the screw handle.

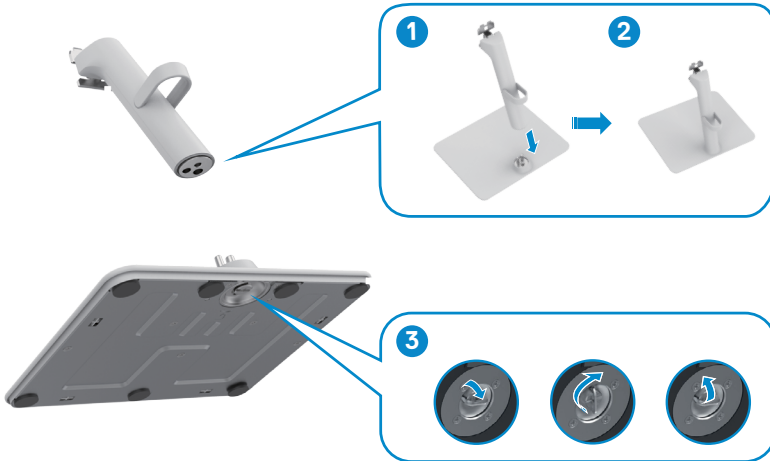

4. Open the protective cover on the monitor to access the VESA slot on the monitor.

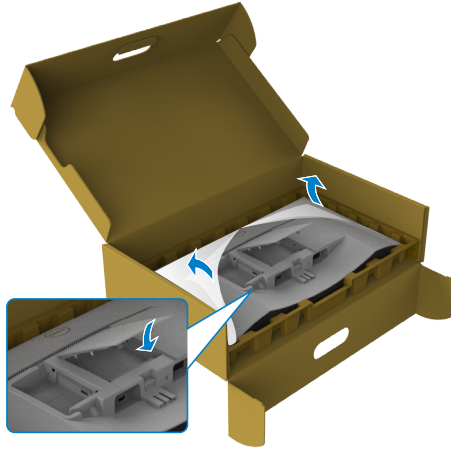

5. Align the tabs on the stand-riser bracket with the grooves at the back of the monitor.
6. Insert the stand-riser bracket into monitor groove until it snaps into its place.

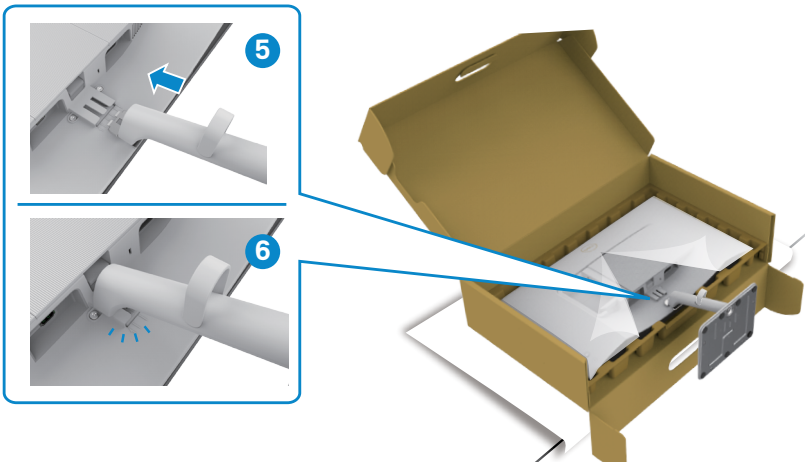

⚠ CAUTION: Hold the stand riser firmly when lifting the monitor to avoid any accidental damage.

7. Hold the stand riser firmly with both hands and lift the monitor carefully, then place it on a flat surface.

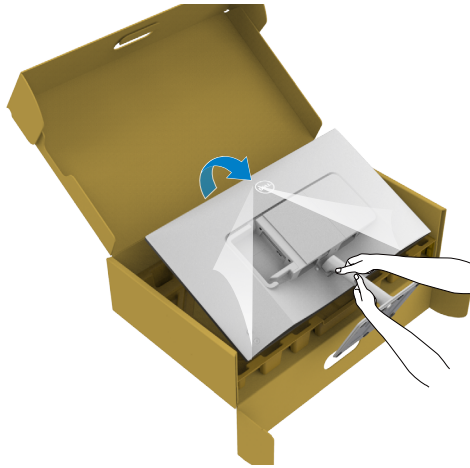

8. Remove the cover from the monitor.

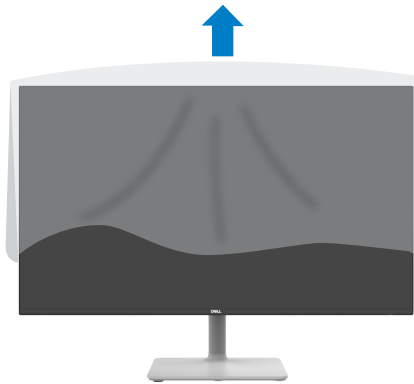

Using the tilt

NOTE: The following instructions are applicable only for the stand that is shipped with your monitor. If you are connecting a stand that you purchased from any other source, follow the set up instructions that were included with the stand.

With the stand attached to the monitor, you can tilt the monitor for the most comfortable viewing angle.

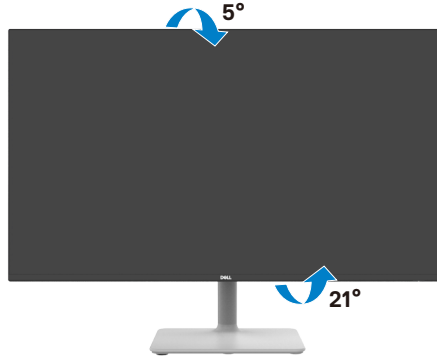

NOTE: The stand is detached when the monitor is shipped from the factory.



Connecting your monitor

⚠ WARNING: Before you begin any of the procedures in this section, follow the [Safety instructions](#).

✍ NOTE: Dell monitors are designed to work optimally with the Dell supplied cables inside the box. Dell does not guarantee the video quality and performance if non-Dell cables are used.

✍ NOTE: Route the cables through the cable management guide before connecting them.

✍ NOTE: Do not connect all the cables to the computer at the same time.

✍ NOTE: The images are for illustration only. The appearance of the computer may vary.

To connect your monitor to the computer:

1. Turn off your computer and disconnect the power cable.
2. Connect the HDMI cable from your monitor to the computer.
3. Connect the power cable to the monitor and the wall outlet.
4. Turn on your monitor.
5. Select the correct input source from the OSD menu on your monitor and then turn on your computer.

Connecting the HDMI cable

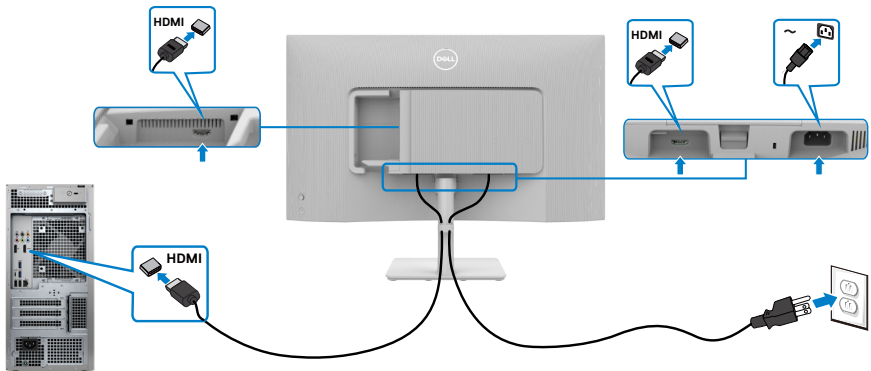

Attaching the side I/O-cover



To attach the side I/O-cover:

- Align and place the tabs on the side I/O-cover with the slots on the display back-cover.
- Press the side I/O-cover to snap it into place.

Organizing your cables

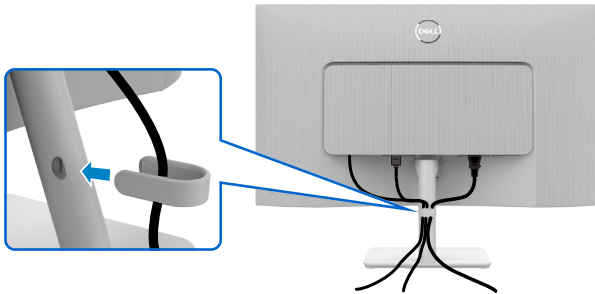

After connecting all necessary cables to your monitor and computer, (see [Connecting your monitor](#) for cable attachment) organize all cables as shown in the image.

If your cable is not able to reach your computer, you may connect directly to the computer without routing through the slot on the monitor stand.



Securing your monitor using Kensington lock (optional)

The security lock slot is at the bottom of the monitor. (See [Security lock slot](#))

Secure your monitor to a table using the Kensington security lock.

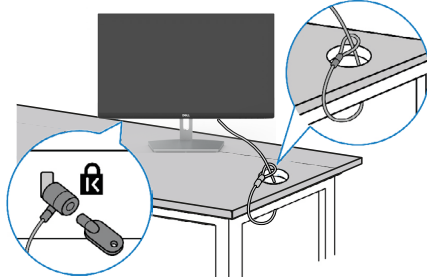

For more information about using the Kensington lock (purchased separately), see the documentation that is shipped with the lock.



NOTE: The image is for illustration only. Appearance of the lock may vary.



Removing the monitor stand

-  **NOTE:** To prevent scratches on the LCD screen when removing the stand, ensure that the monitor is placed on a soft surface and handle it carefully.
-  **NOTE:** The following instructions are applicable only for the stand that was shipped with your monitor. If you are connecting a stand that you purchased from any other source, follow the set up instructions that were included with the stand.

To remove the stand:

1. Place a flat cushion or a sitting mat near the edge of a table and place the monitor on it with the display facing down.
2. Press the stand down to access to the release latch.
3. Press the release latch.
4. While pressing the release latch, slide out the stand assembly from the monitor.

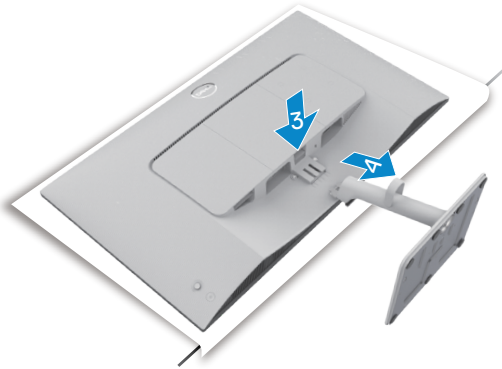

To remove the VESA cover and side I/O-cover:

Lift the VESA cover and side I/O-cover up to release from the back of the display.

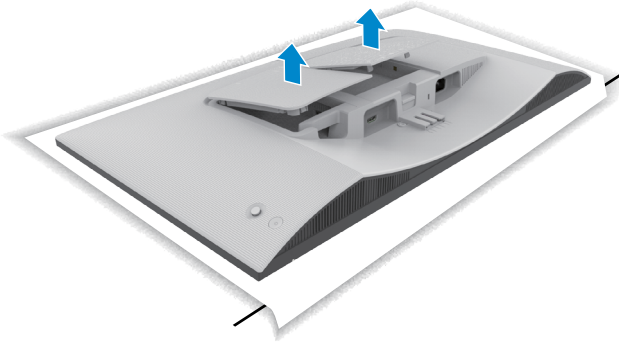

VESA wall mounting (optional)

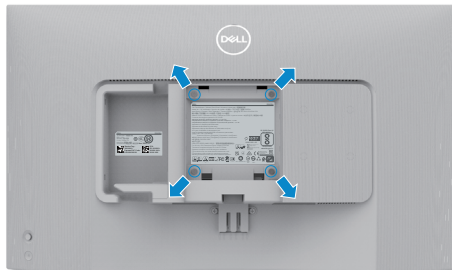

NOTE: Use M4 x 10 mm screws to connect the monitor to the wall-mounting kit.

See the documentation that is shipped with the VESA-compatible wall mounting kit.

1. Place a flat cushion or a sitting mat near the edge of a table and place the monitor on it with the display facing down.
2. Remove the stand.
3. Using a Phillips crosshead screwdriver, remove the four screws that secure the back panel.
4. Connect the mounting bracket from the wall mounting kit to the monitor.
5. Follow the instructions that shipped with the wall-mounting kit and mount the monitor on the wall.

NOTE: For use only with UL or CSA or GS-listed wall mount bracket with minimum weight/load bearing capacity of 13.08 kg (S2425H)/17.2 kg (S2725H).



Operating the monitor

Power on the monitor

Press the power button to turn on your monitor.

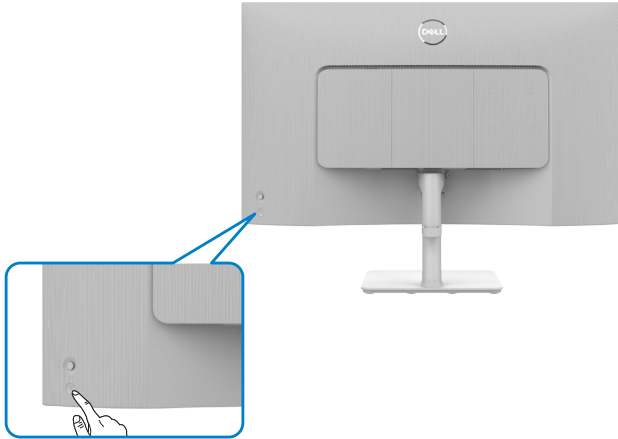

Using the joystick control

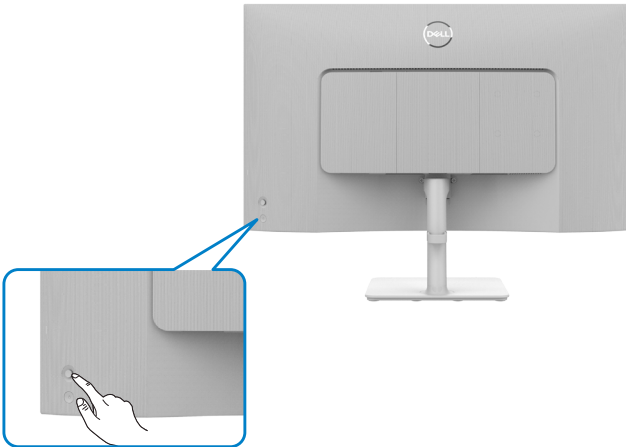

To modify the OSD adjustments using the joystick control on the rear end of the monitor, do the following:

1. Press the joystick button to launch the OSD menu.
2. Move the joystick up/down/left/right to toggle between options.



Joystick Functions

Joystick	Description
----------	-------------



Press joystick to open the OSD menu launcher.



For right and left navigation.



For up and down navigation.



Using the rear-panel controls

Press the joystick to open the OSD Menu Launcher.







Menu Launcher

- Move the joystick up to open the **Main Menu**.
- Move the joystick to left or right to select the **Shortcut Keys**.
- Move the joystick down to exit.

Menu Launcher Details

The following table describes the Menu Launcher icons:

Options	Description
 Shortcut key: Menu	Use this Menu button to launch the On-Screen Display (OSD) and select the OSD menu.
 Shortcut key: Preset Modes	Use this button to choose from a list of preset color modes .
 Shortcut key: Brightness/Contrast	Use this button to directly access the Brightness/Contrast adjustment sliders.
 Shortcut key: Display Info	Use this button to choose from a list of Display Info .



Options**Description**



Shortcut key:
Volume

Use this button to adjust the volume of the built-in speakers.



Shortcut key:
Audio Profile

Use this button to choose from a list of **Audio Profile**.



Shortcut key:
Input Source

Use this button to choose from a list of **Input Source**.



Shortcut key:
Aspect Ratio

Use this button to choose from a list of **Aspect Ratio**.



Exit









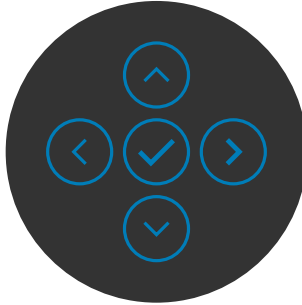

Use this button to go back to the main menu or **Exit** the OSD main menu.



Front-panel button

Use the buttons on the front of the monitor to adjust the image settings.



Joystick	Description
1  Up	Use  to adjust (increase ranges) items in the OSD menu.
2  Down	Use  to adjust (decrease ranges) items in the OSD menu.
3  Previous	For all first level in the Menu list,  exits/closes the OSD menu.
4  Next	For all other levels except first level in the Menu list,  takes to the next level.
5  OK	Use  to confirm your selection.



Using the Main Menu

Icon	Menu and Submenus	Description
------	-------------------	-------------





Brightness/Contrast

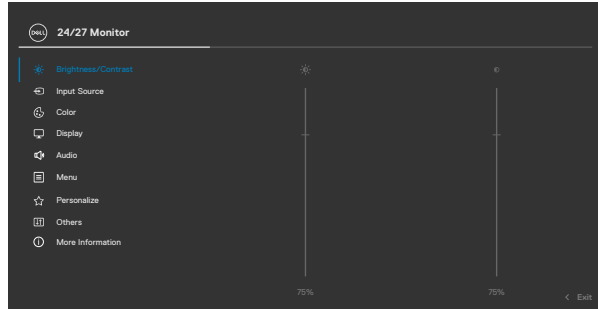

Use this menu to activate **Brightness/Contrast** adjustment.



Brightness

Adjusts the luminance of the backlight (Range: 0 - 100).
Move the joystick  to increase brightness.
Move the joystick  to decrease brightness.

Contrast





Adjust the brightness first, and then adjust contrast only if further adjustment is necessary.
Move the joystick  to increase contrast and move the joystick  to decrease contrast (Range: 0 - 100).
The contrast function adjusts the degree of difference between darkness and lightness on the monitor screen.

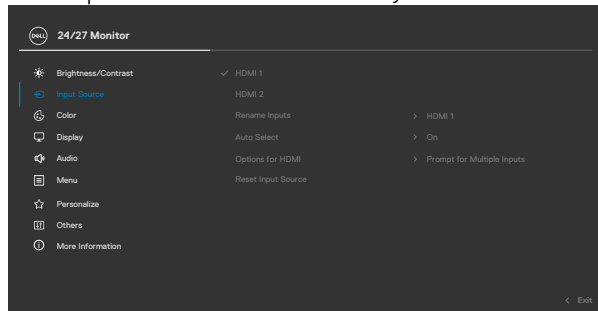

Input Source

Use the **Input Source** menu to select between different video inputs that are connected to your monitor.



Icon	Menu and Submenus	Description
	HDMI 1	Select the HDMI 1 input when using the HDMI 1 connector. Press the joystick button to confirm the selection.
	HDMI 2	Select the HDMI 2 input when using the HDMI 2 connector. Press the joystick button to confirm the selection.
	Rename Inputs	Allows you to rename inputs.
	Auto Select	Allows you to scan for available input sources. Press  to select this function.
	Options for HDMI	Press  to select this function. <ul style="list-style-type: none"> ◆ Prompt for Multiple Inputs: Always displays the Switch to HDMI Video Input message for you to choose whether to switch or not. ◆ Always Switch: Always switches to HDMI video by default while HDMI is connected. ◆ Off: The monitor does not auto-switch to HDMI video from another available input.
	Reset Input Source	Reset all settings under the Input Source menu to the factory defaults. Press  to select this function.
	Color	Adjusts the color setting mode.

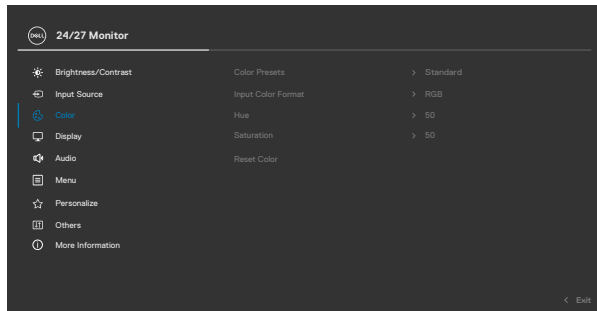

Icon	Menu and Submenus	Description
------	-------------------	-------------

Color Presets When you select **Color Presets**, you can choose **Standard, Movie, FPS, RTS, RPG, Warm, Cool,** or **Custom Color** from the list.

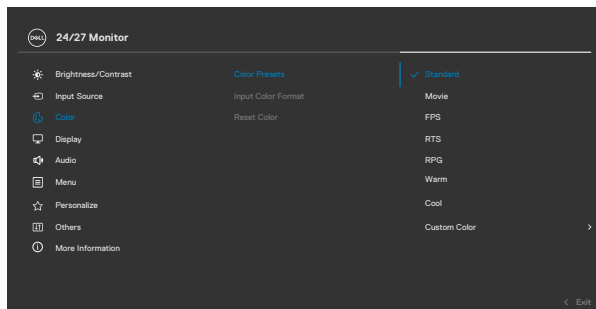

- ◆ **Standard:** Default color setting. This monitor is certified with TUV HW LBL at Standard color preset mode.
- ◆ **Movie:** Loads color setting ideal for movies.
- ◆ **FPS:** Loads color setting ideal for First-Person Shooter(FPS) games.
- ◆ **RTS:** Loads color setting ideal for Real-Time Strategy(RTS) games.
- ◆ **RPG:** Loads color setting ideal for Role-Playing Games(RPG).
- ◆ **Warm:** Increases the color temperature. The screen appears warmer with a red/yellow tint.
- ◆ **Cool:** Decreases the color temperature. The screen appears cooler with a blue tint.
- ◆ **Custom Color:** Allows you to manually adjust the color settings. Press the joystick ⏪ and ⏩ buttons to adjust the Red, Green, and Blue values and create your own preset color mode.



Icon	Menu and Submenus	Description
	Input Color Format	<p>Allows you to set the video input mode to:</p> <ul style="list-style-type: none"> ♦ RGB: Select this option if your monitor is connected to a computer or a media player that supports RGB output. ♦ YCbCr: Select this option if your media player supports only YCbCr output.

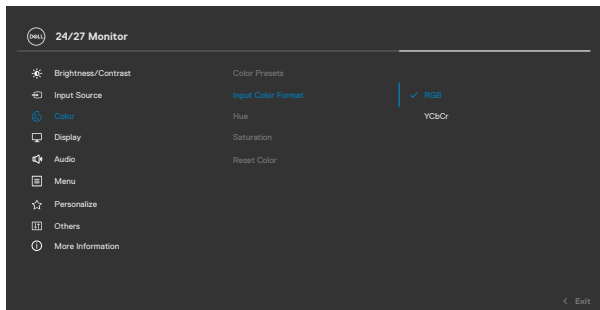





Hue Use joystick and to adjust the **Hue** from 0 to 100.
NOTE: Hue adjustment is available only for Movie, FPS, RTS, and RPG mode.



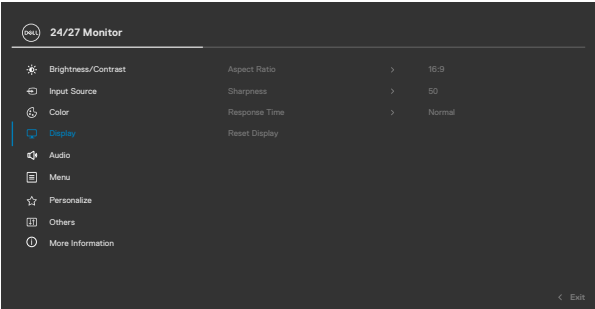

Saturation Use joystick and to adjust the **Saturation** from 0 to 100.
NOTE: Saturation adjustment is available only for Movie, FPS, RTS, and RPG mode.

Reset Color Reset your monitor color settings to the factory defaults.
 Press to select this function.

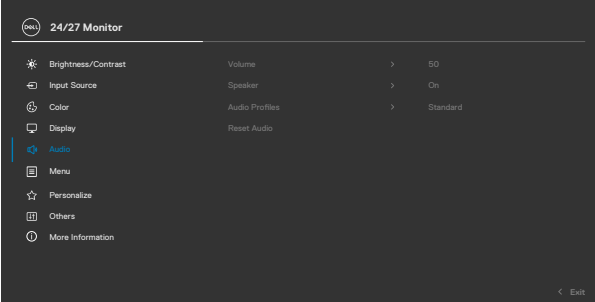

Icon	Menu and Submenus	Description
	Display	Use the Display menu to adjust image.
		
	Aspect Ratio	Adjust the image ratio to 16:9 , 4:3 , and 5:4 .
	Sharpness	Makes the image look sharper or softer. Move the joystick  and  to adjust the sharpness from 0 to 100.
	Response Time	Allows you to set the Response Time to Normal , Fast or Extreme .
	Reset Display	Reset all settings under the Display menu to the factory defaults. Press  to select this function.

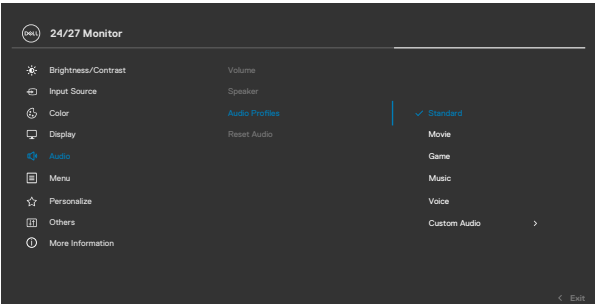

Icon	Menu and Submenus	Description
	Audio	Use the Audio Settings menu to adjust the audio settings.
		
	Volume	Allows you to set the volume level of audio source. Move the joystick  and  to adjust the volume from 0 to 100.
	Speaker	Allows you to turn on or off speaker function.
	Audio Profiles	Expand to show the various audio profiles.
		
		<ul style="list-style-type: none"> ◆ Standard: Default audio setting. ◆ Movie: For motion picture viewing. ◆ Game: For game. ◆ Music: For music listening. ◆ Voice: For speech. ◆ Custom Audio: Allows you to manually adjust the sound. Move the joystick  and  to adjust the setting.
	Reset Audio	Reset all settings under the Audio menu to the factory preset values.



Icon	Menu and Submenus	Description
------	-------------------	-------------



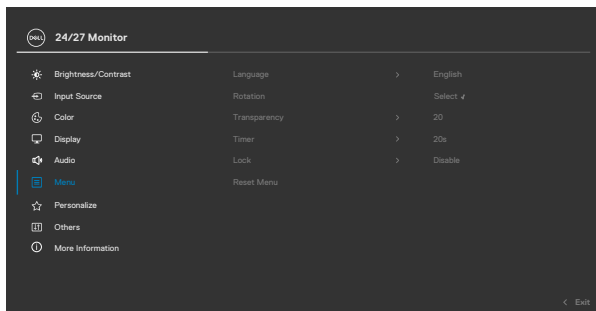

Menu

Select this option to adjust the settings of the OSD, such as the languages of the OSD, the amount of time the menu remains on screen, and so on.





Language	Set the OSD display to one of eight languages. (English, Spanish, French, German, Brazilian Portuguese, Russian, Simplified Chinese, or Japanese).
-----------------	--

Rotation	Rotates the OSD by 0/90/270 degrees. You can press the joystick to rotate each time.
-----------------	--

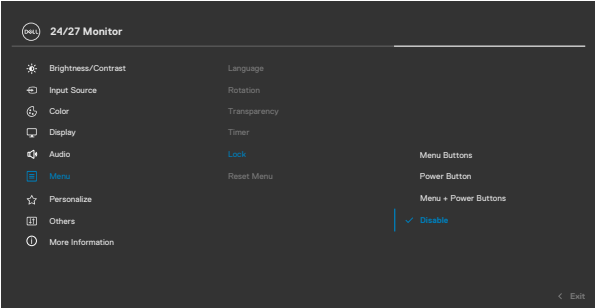

Transparency	Select this option to change the menu transparency by moving the joystick  or  (Range: 0 - 100).
---------------------	--

Timer	OSD Hold Time: Sets the length of time the OSD remains active after you press a button. Move the joystick to adjust the slider in one second increments, from 5 to 60 seconds.
--------------	---



Icon	Menu and Submenus	Description
	Lock	<p>With the control buttons on the monitor is locked, you can prevent people from accessing the controls. It also prevents accidental activation in multiple monitors side-by-side setup.</p>  <ul style="list-style-type: none"> ◆ Menu Buttons: Through OSD to lock the Menu buttons. ◆ Power Button: Through OSD to lock the Power button. ◆ Menu + Power Buttons: Through OSD to lock all Menu and Power buttons. ◆ Disable: Move the joystick left and hold for 4 seconds.
Reset Menu	<p>Reset all settings under the Reset Menu to the factory defaults.</p> <p>Press  to select this function.</p>	

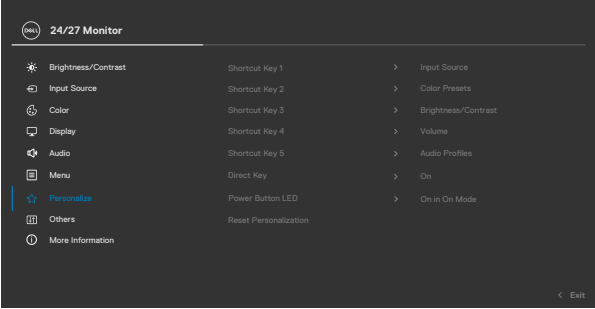

Icon	Menu and Submenus	Description
	Personalize	
	Shortcut key 1	
	Shortcut key 2	
	Shortcut key 3	Select from Preset Modes, Brightness/Contrast, Input Source, Display Info, Aspect Ratio, Volume, Audio Profiles, and Rotation to set as shortcut key.
	Shortcut key 4	
	Shortcut key 5	
	Direct Key	Allows you to access most frequently used functions as direct access with key press on Joystick. You can disable this feature by selecting Off .
	Power Button LED	Allows you to set the state of the power light to save energy.
	Reset Personalization	Reset all settings under the Personalize to the factory defaults. Press  to select this function.



Icon	Menu and Submenus	Description
------	-------------------	-------------



Others

Select this option to adjust the OSD settings such as the **DDC/CI, LCD Conditioning**, and so on.

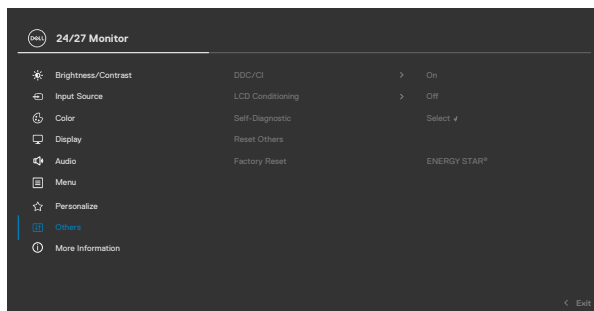

DDC/CI

DDC/CI (Display Data Channel/Command Interface) allows your monitor parameters (brightness, color balance, and so on) to be adjustable by the software on your computer. You can disable this feature by selecting **Off**.

Enable this feature for best user experience and optimum performance of your monitor.

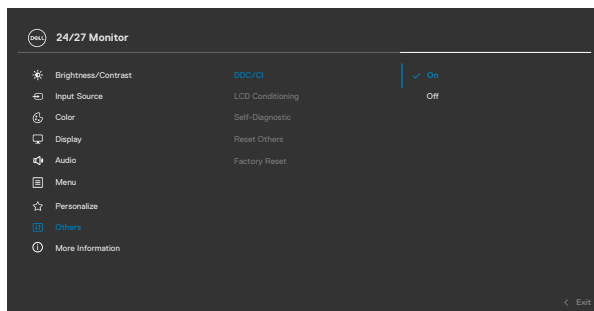

Icon	Menu and Submenus	Description
------	-------------------	-------------

LCD Conditioning

Helps reduce minor cases of image retention. Depending on the degree of image retention, the program may take some time to run. You can enable this feature by selecting **On**.

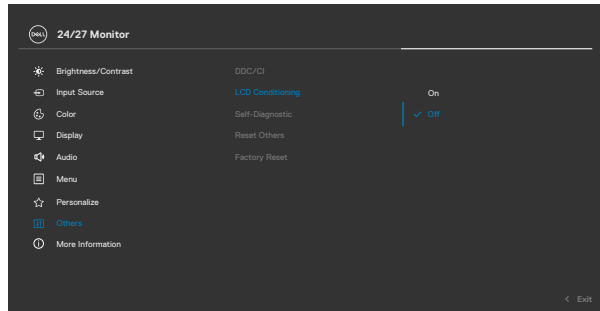

Self-Diagnostic Use this option to run the built-in diagnostics, see [Built-in Diagnostics](#).

Reset Others Reset all settings under the **Others** menu to the factory defaults.

Press to select this function.

Factory Reset Restore all preset values to the factory default settings. These are also the settings for ENERGY STAR® tests.

More Information

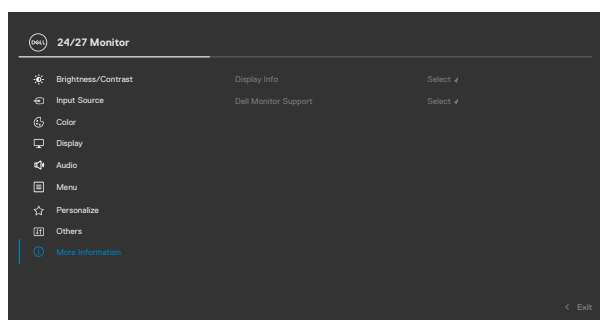

Icon	Menu and Submenus	Description
------	-------------------	-------------

Display Info

Displays the monitor's current settings.
Press  to select this function.

S2425H

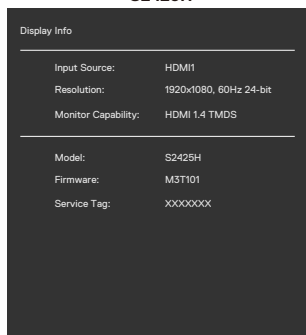

S2725H

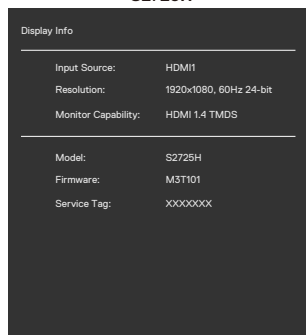

Dell Monitor Support

You can scan the QR code for Dell Monitor Support.

S2425H

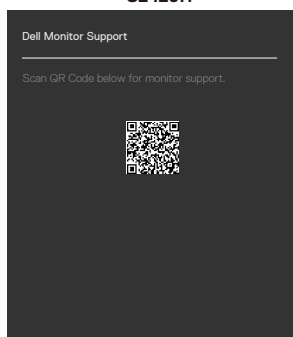

S2725H

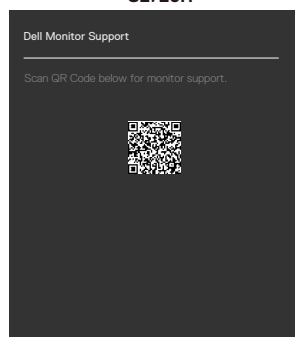

Using the OSD lock function

You can lock the front-panel control buttons to prevent access to the OSD menu and/or power button.

To lock the buttons using the Lock menu:

1. Select the required option to lock.

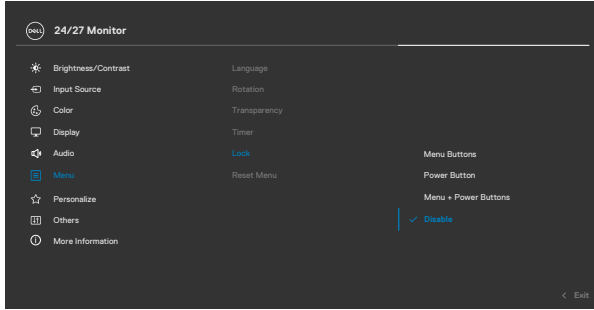

2. The following message appears.

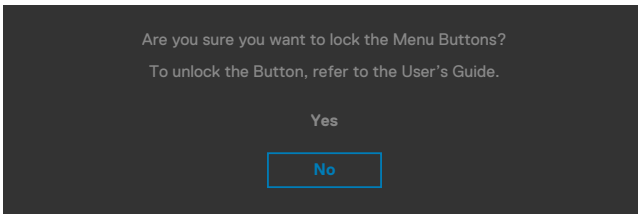

3. Select **Yes** to lock the buttons. Once locked, pressing any control button displays the lock icon .



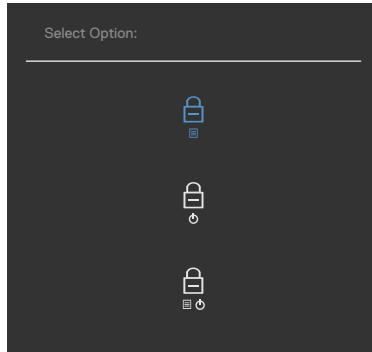

Use the joystick to lock the button(s).

Press the left directional navigation of joystick for four seconds, a menu appears on the screen.



Select one of the following options:



Options	Description
<p>1</p>  <p>Menu Button lock</p>	Select this option to lock the OSD menu function.
<p>2</p>  <p>Power Button lock</p>	Use this option to lock the power button. It prevents the user to turn off the monitor using the power button.
<p>3</p>  <p>Menu and Power Button lock</p>	Use this option to lock the OSD menu and power button to turn off the monitor.

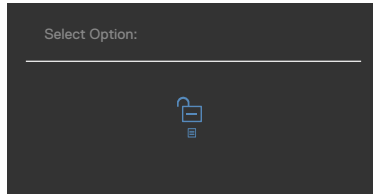

To unlock the button(s).

Press the left directional navigation of the joystick for four seconds until a menu appears on the screen. The following table describes the options to unlock the front-panel control buttons.



Options	Description
1  Menu Button unlock	Use this option to unlock the OSD menu function.
2  Power Button unlock	Use this option to unlock the power button to turn off the monitor.
3  Menu and Power Button unlock	Use this option to unlock the OSD menu and power button to turn off the monitor.



OSD warning messages

When the monitor does not support a particular resolution mode, you can see the following message:

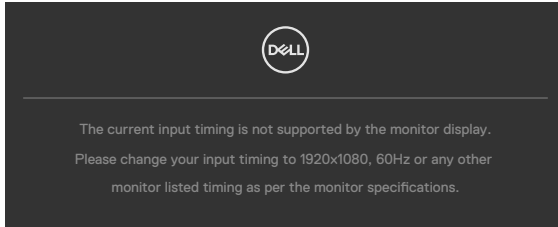

This means that the monitor cannot synchronize with the signal that it is receiving from the computer. See [Resolution Specifications](#) for the horizontal and vertical frequency ranges addressable by this monitor. The recommended mode is 1920x1080. You can see the following message before the DDC/CI function is disabled:

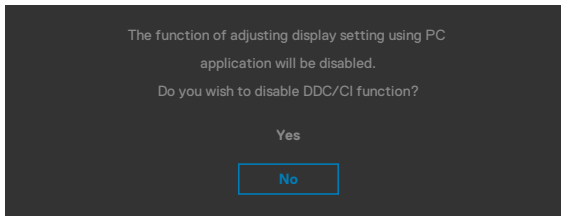

When the monitor enters the **Standby** mode, the following message appears:

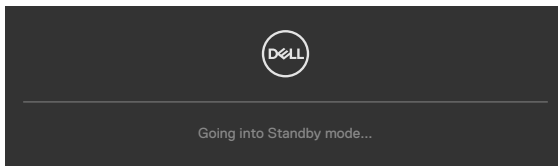

Activate the computer and wake up the monitor to gain access to the [OSD](#).

If the Brightness level adjusted is above the default level 75%, the following message appears:

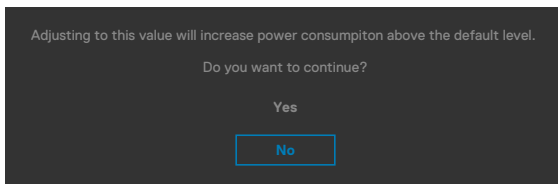

- When you select **Yes**, the power message is displayed only once.
- When you select **No**, the power warning message is displayed again.



- The power warning message appears again only when you do a **Factory Reset** from the OSD menu.

If you press any button other than the power button, the following messages appear depending on the selected input:

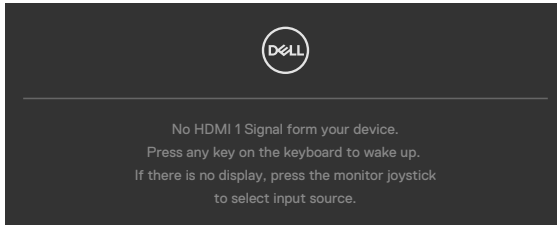

If either HDMI 1 or HDMI 2 input is selected and the corresponding cable is not connected, a floating dialog box as shown below appears.

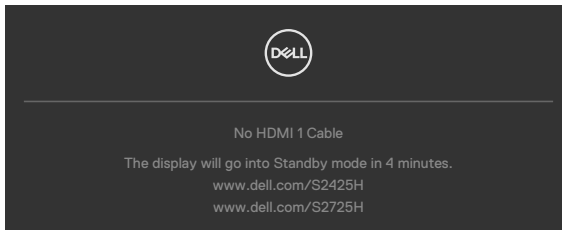

or

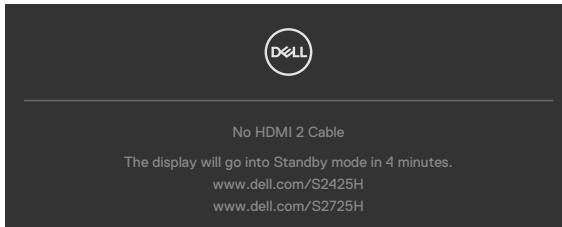

See [Troubleshooting](#) for more information.



Setting the maximum resolution

 **NOTE: The steps may vary slightly depending on the version of Windows you have.**

To set the maximum resolution for the monitor:

In Windows 10 and Windows 11:

1. Right-click on the desktop and click **Display Settings**.
2. If you have more than one monitor connected, ensure that you select **S2425H/S2725H**.
3. Click the **Display Resolution** dropdown list and select **1920 x 1080**.
4. Click **Keep changes**.

If you do not see **1920 x 1080** as an option, you must update your graphics driver to the latest version. Depending on your computer, complete one of the following procedures:

If you have a Dell desktop or laptop:

- Go to <https://www.dell.com/support>, enter your service tag, and download the latest driver for your graphics card.

If you are using a non-Dell computer (laptop or desktop):

- Go to the support site for your computer and download the latest graphic drivers.
- Go to your graphics card website and download the latest graphic drivers.



Troubleshooting

⚠ WARNING: Before you begin any of the procedures in this section, follow the **Safety instructions**.

Self-test

Your monitor provides a self-test feature that allows you to check whether your monitor is functioning properly. If your monitor and computer are properly connected but the monitor screen remains dark, run the monitor self-test by performing the following steps:

1. Turn off both your computer and the monitor.
2. Unplug the video cable from the back of the computer. To ensure proper self-test operation, remove all digital and the analog cables from the back of computer.
3. Turn on the monitor.

The floating dialog box should appear on-screen (against a black background), if the monitor cannot sense a video signal and is working correctly. While in self-test mode, the power LED remains white. Also, depending upon the selected input, one of the dialogs shown below will continuously scroll through the screen.

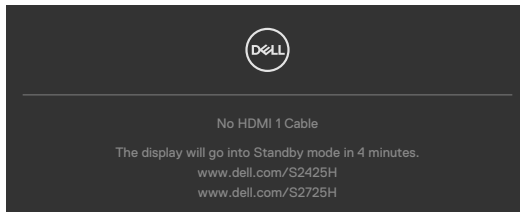

or

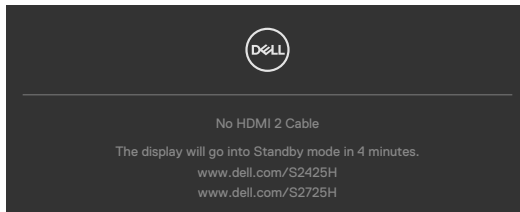

4. This message also appears during normal system operation if the video cable is disconnected or damaged.
5. Turn off your monitor and reconnect the video cable; then turn on both your computer and the monitor.

If your monitor screen remains blank after you use the previous procedure, check your video controller and computer, because your monitor is functioning properly.



Built-in diagnostics

Your monitor has a built-in diagnostic tool that helps you determine if the screen abnormality you are experiencing is an inherent problem with your monitor, or with your computer and video card.

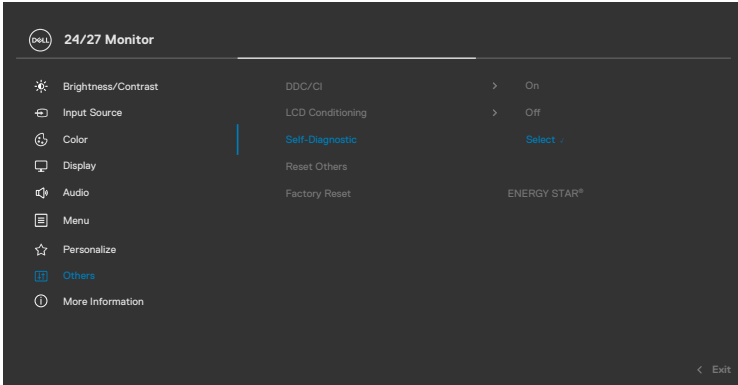

To run the built-in diagnostics:

1. Ensure that the screen is clean (no dust particles on the surface of the screen).
2. Select OSD items of **Self-Diagnostics** in **Others** feature.
3. Press the Joystick button to start the diagnostics. A gray screen is displayed.
4. Observe if the screen has any defects or abnormalities.
5. Toggle the joystick once again until a red screen is displayed.
6. Observe if the screen has any defects or abnormalities.
7. Repeat steps 5 and 6 until the screen displays green, blue, black, and white colors. Note any abnormalities or defects.

The test is complete when a text screen is displayed. To exit, toggle the joystick control again.

If you do not detect any screen abnormalities upon using the built-in diagnostic tool, the monitor is functioning properly. Check the video card and computer.



Common problems

The following table contains general information about common monitor problems you might encounter and the possible solutions:

Common symptoms	What you experience	Possible solutions
No video/ Power LED off	No picture	<ul style="list-style-type: none">· Ensure that the video cable connecting the monitor and the computer is properly connected and secure.· Verify that the power outlet is functioning properly using any other electrical equipment.· Ensure that the power button is on.· Ensure that the correct input source is selected in the Input Source menu.
No video/ Power LED on	No picture or no brightness	<ul style="list-style-type: none">· Increase brightness and contrast controls through OSD.· Perform monitor self-test feature check.· Check for bent or broken pins in the video cable connector.· Run the built-in diagnostics.· Ensure that the correct input source is selected in the Input Source menu.
Missing pixels	LCD screen has spots	<ul style="list-style-type: none">· Cycle power on-off.· Pixel that is permanently off is a natural defect that can occur in LCD technology.· For more information about Dell Monitor Quality and Pixel Policy, see Dell Support site at: https://www.dell.com/support/monitors.
Stuck-on pixels	LCD screen has bright spots	<ul style="list-style-type: none">· Cycle power On-Off.· Pixel that is permanently off is a natural defect that can occur in LCD technology.· For more information about Dell Monitor Quality and Pixel Policy, see Dell Support site at: https://www.dell.com/support/monitors.
Brightness problems	Picture too dim or too bright	<ul style="list-style-type: none">· Reset the monitor to factory settings.· Adjust brightness and contrast controls through OSD.



Common symptoms	What you experience	Possible solutions
Safety-related issues	Visible signs of smoke or sparks	<ul style="list-style-type: none"> · Do not perform any troubleshooting steps. · Contact Dell immediately.
Intermittent problems	The monitor turns on and off	<ul style="list-style-type: none"> · Ensure that the video cable connecting the monitor to the computer is connected properly and is secure. · Reset the monitor to factory settings. · Perform monitor self-test feature check to determine if the intermittent problem occurs in self-test mode.
Missing color	Picture missing color	<ul style="list-style-type: none"> · Perform monitor self-test. · Ensure that the video cable connecting the monitor to the computer is connected properly and is secure. · Check for bent or broken pins in the video cable connector.
Wrong color	Picture color not good	<ul style="list-style-type: none"> · Change the settings of the Preset Modes in the Color menu OSD depending on the application. · Adjust R/G/B value under Custom Color in Color menu OSD. · Change the Input Color Format to computer RGB or YCbCr in the Color menu OSD. · Run the built-in diagnostics.
Image retention from a static image left on the monitor for a long period of time	Faint shadow from the static image that is displayed appears on the screen	<ul style="list-style-type: none"> · Set the screen to turn off after a few minutes of screen idle time. These can be adjusted in Windows Power Options or Mac Energy Saver setting. · Alternatively, use a dynamically changing screensaver.
Screen image is too small	Image is centered on screen, but does not fill entire viewing area	<ul style="list-style-type: none"> · Check the Aspect Ratio setting in the Display menu OSD. · Reset the monitor to factory settings.



Common symptoms	What you experience	Possible solutions
Cannot adjust the monitor with the buttons on the front panel	OSD does not appear on the screen	<ul style="list-style-type: none"> · Turn off the monitor, unplug the monitor power cable, plug it back, and then turn on the monitor.
No Input Signal when user controls are pressed	No picture, the LED light is white	<ul style="list-style-type: none"> · Check the signal source. Ensure that the computer is not in the power saving mode by moving the mouse or pressing any key on the keyboard. · Check whether the signal cable is plugged in properly. Connect the signal cable again, if necessary. · Reset the computer or video player.
The picture does not fill the entire screen	The picture cannot fill the height or width of the screen	<ul style="list-style-type: none"> · Due to different video formats (aspect ratio) of DVDs, the monitor may display in full screen. · Run the built-in diagnostics.



Regulatory information

FCC notices (U.S. only) and other regulatory information

For FCC notices and other regulatory information, see the regulatory compliance website at https://www.dell.com/regulatory_compliance.

EU product database for energy label and product information sheet



S2425H: <https://eprel.ec.europa.eu/qr/1856260>

S2725H: <https://eprel.ec.europa.eu/qr/1856262>



Contacting Dell

To contact Dell for sales, technical support, or customer service issues, see www.dell.com/contactdell.

-  **NOTE: Availability varies by country and product, and some services may not be available in your country.**
-  **NOTE: If you do not have an active internet connection, you can find contact information on your purchase invoice, packing slip, bill, or Dell product catalog.**

