



# Alienware AW2725DF Monitor User's Guide

Monitor Model: AW2725DF  
Regulatory Model: AW2725DFb

A L I E N W A R E™ 

# Notes, cautions, and warnings

-  **NOTE:** A NOTE indicates important information that helps you make better use of your computer.
-  **CAUTION:** A CAUTION indicates potential damage to hardware or loss of data if instructions are not followed.
-  **WARNING:** A WARNING indicates a potential for property damage, personal injury, or death.

© 2024 Dell Inc. or its subsidiaries. All rights reserved. Dell, EMC, and other trademarks are trademarks of Dell Inc. or its subsidiaries. Other trademarks may be trademarks of their respective owners.

2024 - 06

Rev. A02

# Contents

<b>Safety instructions</b> .....	<b>6</b>
<b>About your monitor</b> .....	<b>7</b>
Package contents .....	7
Product features .....	9
Operating system compatibility .....	10
Identifying parts and controls .....	11
Front view .....	11
Back view .....	12
Rear and bottom view .....	13
<b>Monitor specifications</b> .....	<b>15</b>
Resolution specifications .....	17
Supported video modes .....	17
DisplayPort preset display modes .....	18
HDMI preset display modes .....	19
Electrical specifications .....	20
Physical characteristics .....	21
Environmental characteristics .....	22
<b>Pin assignments</b> .....	<b>23</b>
DisplayPort connector .....	23
HDMI connector .....	24
Universal Serial Bus (USB) interface .....	25
<b>Plug-and-Play capability</b> .....	<b>27</b>
<b>QD-OLED monitor quality and pixel policy</b> .....	<b>28</b>
<b>Ergonomics</b> .....	<b>28</b>
<b>Handling and moving your display</b> .....	<b>30</b>
<b>Maintenance guidelines</b> .....	<b>31</b>
Cleaning your monitor .....	31

<b>Setting up the monitor</b> . . . . .	<b>33</b>
Attaching the stand . . . . .	33
Connecting the computer . . . . .	37
Connecting the DisplayPort (DP to DP) cable . . . . .	38
Connecting the USB-C to DP cable . . . . .	38
Connecting the HDMI cable (optional) . . . . .	38
Removing the monitor stand . . . . .	39
VESA wall mounting (optional) . . . . .	41
<b>Operating the monitor</b> . . . . .	<b>42</b>
Turn on the monitor . . . . .	42
Using the joystick . . . . .	42
Using the On-Screen Display (OSD) menu . . . . .	43
Accessing the Menu Launcher . . . . .	43
Accessing the menu system . . . . .	45
Console mode (HDMI only) . . . . .	67
OSD warning message . . . . .	68
Locking the control buttons . . . . .	72
Setting the maximum resolution . . . . .	73
Requirements to view or playback HDR content . . . . .	74
Using the tilt, swivel, pivot and height adjustment . . . . .	75
Tilt and swivel adjustment . . . . .	75
Height adjustment . . . . .	75
Pivot adjustment . . . . .	76
Rotate clockwise . . . . .	76
Rotate counterclockwise . . . . .	77
Adjusting the rotation display settings of your system . . . . .	78
<b>Using AlienFX™ function</b> . . . . .	<b>79</b>
Prerequisites . . . . .	79
Installing AWCC through Windows update . . . . .	79
Installing AWCC from the Dell Support website . . . . .	80

Adjusting the lighting effects .....	80
Setting .....	83
Customization of AlienVision .....	84
Game configuration .....	85
Display configuration .....	86
PIP/PBP configuration .....	86
<b>Troubleshooting .....</b>	<b>87</b>
Self-test .....	87
Built-in diagnostics .....	88
Screen test .....	88
Fan test .....	89
Common problems .....	90
Universal Serial Bus (USB) specific problems .....	98
<b>Regulatory information .....</b>	<b>100</b>
FCC notices (U.S. only) and other regulatory information .....	100
EU product database for energy label and product information sheet .....	100
<b>Contacting Dell .....</b>	<b>101</b>

# Safety instructions

Use the following safety guidelines to protect your monitor from potential damage and to ensure your personal safety. Unless otherwise noted, each procedure included in this document assumes that you have read the safety information that shipped with your monitor.

 **NOTE: Before using the monitor, read the safety information that is shipped with your monitor and printed on the product. Keep the documentation at a secure location for future reference.**

 **WARNING: Use of controls, adjustments, or procedures other than those specified in this documentation may result in exposure to shock, electrical hazards, and/or mechanical hazards.**

 **WARNING: The possible long-term effect of listening to audio at high volume through the headphones (on monitor that support it) may cause damage to your hearing ability.**

- Place the monitor on a solid surface and handle it carefully. The screen is fragile and can be damaged if dropped or hit with a sharp object.
- Ensure that your monitor is electrically rated to operate with the AC power available in your location.
- Keep the monitor in room temperature. Excessive cold or hot conditions can have an adverse effect on the liquid crystals of the display.
- Connect the power cable from the monitor to a wall outlet that is near and accessible. See [Connecting the computer](#).
- Do not place and use the monitor on a wet surface or near water.
- Do not subject the monitor to severe vibration or high impact conditions. For example, do not place the monitor inside a car trunk.
- Unplug the monitor when it is going to be left unused for an extended period.
- To avoid electric shock, do not attempt to remove any cover or touch the inside of the monitor.
- Read these instructions carefully. Keep this document for future reference. Follow all warnings and instructions marked on the product.
- Certain monitors can be wall mounted using the VESA mount that is sold separately. Ensure to use the correct VESA specifications as mentioned in the wall mounting section of the *User's Guide*.





For information on safety instructions, see the *Safety, Environmental, and Regulatory Information* (SERI) document that is shipped with your monitor.



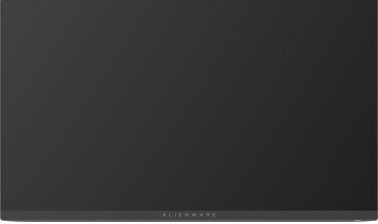

# About your monitor

## Package contents

The following table provides the list of components that are shipped with your monitor. If any component is missing, contact Dell. For more information, see [Contacting Dell](#).

 **NOTE: Some components may be optional and may not ship with your monitor. Some features may not be available in certain countries.**

Component image	Component description
	Display
	Stand riser
	Stand base
	I/O cover
	Power cable (varies by country)

Component image	Component description
	DisplayPort to DisplayPort 1.4 cable (1.80 M)
	USB-C to DisplayPort 1.4 cable (1 M)
	USB 3.2 Gen 1 (5 Gbps) upstream cable (enables the USB ports on the monitor, 1.80 M)
	Microfiber cloth
	<ul style="list-style-type: none"> <li>▪ Quick Start Guide</li> <li>▪ Safety, Environmental, and Regulatory Information</li> <li>▪ Factory calibration report</li> <li>▪ Alienware Sticker</li> </ul>



## Product features

The **Alienware AW2725DF** is a Quantum Dot-Organic Light Emitting Diode (QD-OLED) display that uses Oxide TFT as active element. The monitor features include:

- 678.20 mm (26.70 in.) viewable area (measured diagonally).
- AMD FreeSync Premium Pro Technology and VESA AdaptiveSync Display certification minimize graphic distortions like screen tearing and stuttering for a smoother, fluid gameplay.
- Supports AMD FreeSync Premium Pro Technology and VESA AdaptiveSync Display, with a refresh rate of 360 Hz and an extremely rapid response time of 0.03 ms gray to gray.
- Color gamut of DCI-P3 99.3%.
- Tilt, swivel, pivot, and height adjustment capabilities.
- Removable stand and Video Electronics Standards Association (VESA) 100 mm mounting holes for flexible mounting solutions.
- Digital connectivity through two DisplayPort and one HDMI port.
- The monitor is equipped with:
  - One SuperSpeed USB 5 Gbps (USB 3.2 Gen 1) Type-B upstream port
  - One SuperSpeed USB 5 Gbps (USB 3.2 Gen 1) Type-C downstream charging port
  - Three SuperSpeed USB 5 Gbps (USB 3.2 Gen 1) Type-A downstream ports
- Plug-and-play capability if supported by your computer.
- On-Screen Display (OSD) adjustments for ease of setup and screen optimization.
- Supports Picture by Picture (PBP), Picture in Picture (PIP), and **Console Mode**.
- **AW2725DF** offers a couple of preset modes for user's own preference, including:
  - **Creator**
  - First-Person Shooter (**FPS**)
  - Multiplayer Online Battle Arena/Real-Time Strategy (**MOBA/RTS**)
  - Role-Playing Game (**RPG**)
  - Racing (**SPORTS**)
  - Three customizable game modes

In addition, key enhanced gaming features such as **Timer**, **Frame Rate**, and **Display Alignment** are provided to help improve gamer's performance and provide best-in game advantage.

- Security-lock slot.
- Power consumption  $\leq 0.5$  W in Standby Mode.
- VESA DisplayHDR 400 True Black.
- Optimize eye comfort with a flicker-free screen and ComfortView Plus feature.
- The monitor uses Low Blue Light panel and is compliant with TÜV Rheinland (Hardware Solution) at factory reset or default setting. This built-in low blue light solution reduces hazardous blue light emissions by adjusting display parameters, without sacrificing true-to-life colors.

**⚠ WARNING: The possible long-term effects of blue light emission from the monitor may cause damage to the eyes, which includes but is not limited to eye fatigue and digital eye strain. ComfortView Plus feature is designed to reduce the amount of blue light emitted from the monitor to optimize eye comfort.**

## Operating system compatibility

- Windows 10 and later\*

\*The operating system compatibility on Dell and Alienware branded monitors may vary based on factors such as:

- Specific release date(s) when operating system versions, patches, or updates are available.
- Specific release date(s) when Dell and Alienware branded monitor firmware, software application, or driver updates are available on the Dell support website.

# Identifying parts and controls

## Front view

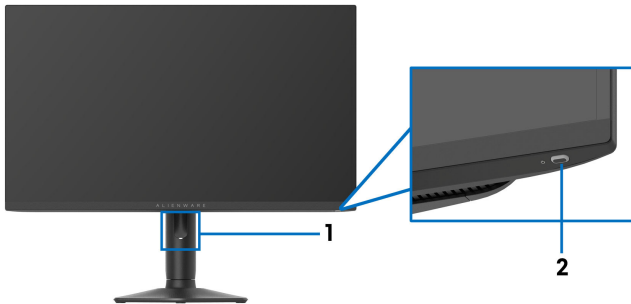

Label	Description	Use
1	Cable-management slot (on the front side of the stand)	To organize the cables neatly.
2	Power button (with LED indicator)	To turn the monitor on or off. Solid blue light indicates that the monitor is turned on and functioning normally. Blinking white light indicates that the monitor is in Standby Mode.

## Back view

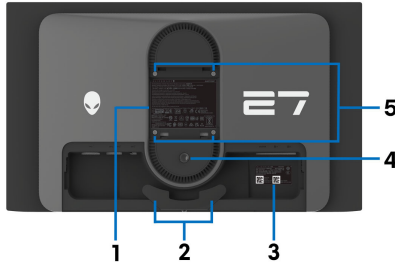

## Back view without monitor stand

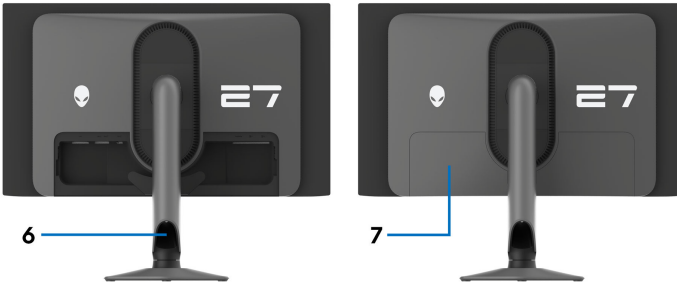

## Back view with monitor stand



Label	Description	Use
1	Regulatory label	Lists the regulatory approvals.
2	Cable-management clips (2)	To organize the cables neatly.
3	Barcode, serial number, and Service Tag label	See this label if you need to contact Dell for technical support. The Service Tag is a unique alphanumeric identifier that enables Dell service technicians to identify the hardware components in your monitor and access warranty information.
4	Stand release button	Releases the stand from the monitor.
5	VESA mounting holes (100 mm x 100 mm - behind VESA Cover)	Wall mount the monitor using VESA-compatible wall mount kit (100 mm x 100 mm).

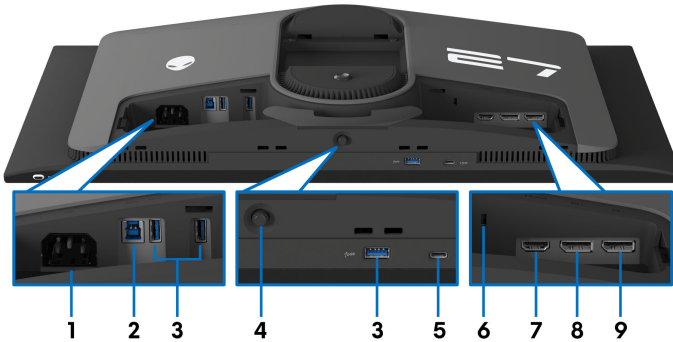

Label	Description	Use
6	Cable-management slot (at the back of the stand)	To organize cables by routing them through this slot.
7	I/O cover	Protects the I/O ports.

### Rear and bottom view



**Rear and bottom view without monitor stand**

Label	Description	Use
1	Power connector	Connect the power cable (shipped with your monitor).
2	SuperSpeed USB 5 Gbps (USB 3.2 Gen 1) Type-B upstream port	Connect the USB cable (shipped with your monitor) to this port and your computer to enable the USB ports on your monitor.
3	SuperSpeed USB 5 Gbps (USB 3.2 Gen 1) Type-A downstream ports (3)	<p>Connect your USB 3.2 Gen 1 (5 Gbps) device.</p> <p> <b>NOTE: To use these ports, you must connect the USB cable (shipped with your monitor) to the USB upstream port on the monitor and to your computer.</b></p> <p> <b>NOTE: To prevent signal interference, avoid connecting other USB devices to the adjacent port when using a wireless USB device on a downstream USB port.</b></p>

Label	Description	Use
4	Joystick	Use it to control the OSD menu. For more information, see <a href="#">Operating the monitor</a> .
5	SuperSpeed USB 5 Gbps (USB 3.2 Gen 1) Type-C downstream port with Power Charging	<p>Connect to charge your USB device.</p> <p> <b>NOTE: To use this port, you must connect the USB cable (shipped with your monitor) to the USB upstream port on the monitor and to your computer.</b></p> <p> <b>NOTE: To prevent signal interference, avoid connecting other USB devices to the adjacent port when using a wireless USB device on a downstream USB port.</b></p>
6	Security-lock slot (based on Kensington Security Slot)	Secure your monitor using a security lock (purchased separately) to prevent unauthorized movement of your monitor.
7	HDMI port	Connect your computer with the HDMI cable (sold separately).
8	DisplayPort (DP 1)	<p>Connect your computer with one of the following cables shipped with your monitor:</p> <ul style="list-style-type: none"> <li>▪ DisplayPort-DisplayPort cable</li> <li>▪ USB-C-DisplayPort cable</li> </ul>
9	DisplayPort (DP 2)	

## Monitor specifications

Description	Value
Screen type	Color Active Matrix
Panel technology	QD OLED
Aspect ratio	16:9
Viewable image	
Diagonal:	678.20 mm (26.70 in.)
Width (active area)	590.42 mm (23.24 in.)
Height (active area)	333.72 mm (13.14 in.)
Total area	197034.96 mm <sup>2</sup> (305.37 in. <sup>2</sup> )
Pixel pitch	0.2292 mm x 0.2292 mm
Pixel per inch (PPI)	111
Viewing angle:	
Vertical	178° (typical)
Horizontal	178° (typical)
Luminance output	250 cd/m <sup>2</sup> (typical)(SDR full white pattern) 450 cd/m <sup>2</sup> (typical)(HDR TB400) 1000 cd/m <sup>2</sup> (typical)(HDR peak)
Contrast ratio	1.5 million: 1 at SDR and HDR
Faceplate coating	Anti-reflection
Luminous substance	OLED
Response time	0.03 ms (gray-to-gray)
Color depth	1.07 billion colors
Color gamut	DCI-P3 Typ. 99.3% (CIE 1976)
HDR support	VESA DisplayHDR 400 True Black
Calibration accuracy	$\Delta E_{2000} \leq 2$ (average) at sRGB preset mode $\Delta E_{2000} \leq 2$ (average) at DCI-P3 preset mode
Integrated devices	<ul style="list-style-type: none"> <li>▪ SuperSpeed USB 5 Gbps (USB 3.2 Gen 1) hub (with one USB 3.2 Gen 1 (5 Gbps) upstream port)</li> <li>▪ 4 x SuperSpeed USB 5 Gbps (USB 3.2 Gen 1) downstream ports (including one USB-C port which supports BC1.2 power-charging)</li> </ul>

Description	Value
Connectivity	<p><b>Rear</b></p> <ul style="list-style-type: none"> <li>▪ 2 x DP 1.4 (HDCP 1.4 &amp; 2.3)(Supports up to QHD 2560 x 1440 360 Hz, HDR, VRR)</li> <li>▪ 1 x HDMI 2.1 (HDCP 1.4 &amp; 2.3)(Supports up to QHD 2560 x 1440 144 Hz TMDS, HDR, VRR as per specified in HDMI 2.1)</li> <li>▪ 1 x USB 3.2 Gen 1 (5 Gbps) Type-B upstream port</li> <li>▪ 2 x USB 3.2 Gen 1 (5 Gbps) Type-A downstream ports</li> </ul> <p><b>Bottom/Quick Access</b></p> <ul style="list-style-type: none"> <li>▪ 1 x USB 3.2 Gen 1 (5 Gbps) Type-C downstream port which supports BC1.2 power-charging</li> <li>▪ 1 x USB 3.2 Gen 1 (5 Gbps) Type-A downstream port</li> </ul>
Border width (edge of monitor to active area)	
Top	5.84 mm
Left/Right	9.35 mm/9.35 mm
Bottom	19.44 mm
Adjustability	
Height adjustable stand	0 mm to 110 mm
Tilt	-5° to 21°
Swivel	-20° to 20°
Pivot	-90° to 90°
Security	Security-lock slot (cable lock sold separately)
Dell Display Manager compatibility	Easy Arrange and other key features
Alienware Command Center (AWCC)	Yes



## Resolution specifications

<b>Description</b>	<b>DisplayPort</b>	<b>HDMI port</b>
Horizontal scan range	27 kHz to 621.32 kHz (automatic)	27 kHz to 223 kHz (automatic)
Vertical scan range	48 Hz to 360 Hz (automatic)	48 Hz to 144 Hz (automatic)
Maximum preset resolution	2560 x 1440 at 359.98 Hz (DSC enabled and visually lossless)	2560 x 1440 at 143.97 Hz

## Supported video modes

<b>Description</b>	<b>Value</b>
Video display capabilities (DisplayPort)	1440p, 1080p, 720p, 576p, 480p
Video display capabilities (HDMI)	1440p, 1080p, 1080i, 720p, 576p, 480p

## DisplayPort preset display modes

Display mode	Horizontal frequency (kHz)	Vertical frequency (Hz)	Pixel clock (MHz)	Sync polarity (Horizontal/Vertical)
640 x 480	31.47	59.94	25.18	-/-
640 x 480	37.50	75	31.50	-/-
720 x 400	31.47	70.08	28.32	-/+
800 x 600	37.88	60.32	40	+/+
800 x 600	46.88	75	49.50	+/+
1024 x 768	48.36	60	65	-/-
1024 x 768	60.02	75.03	78.75	+/+
1152 x 864	67.50	75	108	+/+
1280 x 1024	63.98	60.02	108	+/+
1280 x 1024	79.98	75.03	135	+/+
1600 x 900	60	60	108	+/+
1920 x 1080	67.50	60	148.50	+/+
1920 x 1080	135	120	297	+/+
1920 x 1080	278.12	239.76	567.36	+/-
2560 x 1440	88.79	59.95	241.50	+/-
2560 x 1440	183	120	497.75	+/-
2560 x 1440	222.06	143.91	592	+/-
2560 x 1440	388.51	239.97	1056.75	+/-
2560 x 1440	621.32	359.98	1690	+/-

## HDMI preset display modes

Display mode	Horizontal frequency (kHz)	Vertical frequency (Hz)	Pixel clock (MHz)	Sync polarity (Horizontal/Vertical)
640 x 480	31.47	59.94	25.18	-/-
640 x 480	37.50	75	31.50	-/-
720 x 400	31.47	70.08	28.32	-/+
800 x 600	37.88	60.32	40	+/+
800 x 600	46.88	75	49.50	+/+
1024 x 768	48.36	60	65	-/-
1024 x 768	60.02	75.03	78.75	+/+
1152 x 864	67.50	75	108	+/+
1280 x 1024	63.98	60.02	108	+/+
1280 x 1024	79.98	75.03	135	+/+
1600 x 900	60	60	108	+/+
1920 x 1080	67.50	60	148.50	+/+
1920 x 1080	135	120	297	+/+
2560 x 1440	88.79	59.95	241.50	+/-
2560 x 1440	183	120	497.75	+/-
2560 x 1440	217.39	143.97	591.31	+/-

 **NOTE: This monitor supports AMD FreeSync Premium Pro Technology and VESA AdaptiveSync Display (only DisplayPort).**

## Electrical specifications

Description	Value
Video input signals	HDMI/DP, 600 mV for each differential line, 100 $\Omega$ input impedance per differential pair
AC input voltage/frequency/current	100 VAC to 240 VAC/50 Hz or 60 Hz $\pm$ 3 Hz/2 A (typical)
Inrush current	<ul style="list-style-type: none"> <li>▪ 120 V: 30 A (maximum) at 0°C (cold start)</li> <li>▪ 240 V: 60 A (maximum) at 0°C (cold start)</li> </ul>
Power consumption	<ul style="list-style-type: none"> <li>▪ 0.3 W (Off mode)<sup>1</sup></li> <li>▪ 0.5 W (Standby mode)<sup>1</sup></li> <li>▪ 27.6 W (On mode)<sup>1</sup></li> <li>▪ 130.0 W (Max.)<sup>2</sup></li> <li>▪ 34.1 W (<math>P_{on}</math>)<sup>3</sup></li> <li>▪ 106.8 kWh (TEC)<sup>3</sup></li> </ul>

<sup>1</sup> As defined in EU 2019/2021 and EU 2019/2013.

<sup>2</sup> Maximum brightness and contrast setting with maximum power loading on all USB ports.

<sup>3</sup>  $P_{on}$ : Power consumption of On Mode that is measured with reference to Energy Star test method.

TEC: Total Energy Consumption in kWh that is measured with reference to Energy Star test method.

This document is informational only and reflects laboratory performance. Your product may perform differently, depending on the software, components and peripherals you ordered and shall have no obligation to update such information.

So, the customer should not rely upon this information in making decisions about electrical tolerances or otherwise. No warranty as to accuracy or completeness is expressed or implied.

## Physical characteristics

Description	Value
<b>Signal cable type</b>	<ul style="list-style-type: none"> <li>▪ Digital: HDMI, 19 pins (cable not included)</li> <li>▪ Digital: DisplayPort, 20 pins</li> <li>▪ Digital: USB-C (24 pins) to DisplayPort (20 pins)</li> <li>▪ Universal Serial Bus: USB, 9 pins</li> </ul>
<p> <b>NOTE: Dell monitors are designed to work optimally with the video cables that are shipped with your monitor. As Dell does not have control over different cable suppliers in the market, the type of material, connector, and process used to manufacture these cables, Dell does not guarantee video performance of cables that are not shipped with your Dell monitor.</b></p>	
<b>Dimensions (with stand):</b>	
Height (extended)	516.20 mm (20.32 in.)
Height (compressed)	406.20 mm (15.99 in.)
Width	609.11 mm (23.98 in.)
Depth	243.69 mm (9.59 in.)
<b>Dimensions (without stand):</b>	
Height	359.00 mm (14.13 in.)
Width	609.11 mm (23.98 in.)
Depth	67.60 mm (2.66 in.)
<b>Stand dimensions:</b>	
Height (extended)	411.80 mm (16.21 in.)
Height (compressed)	383.34 mm (15.09 in.)
Width	233.40 mm (9.19 in.)
Depth	243.69 mm (9.59 in.)
Base	233.40 mm (9.19 in.) x 233.14 mm (8.79 in.)
<b>Weight:</b>	
Weight with packaging	9.97 kg (21.97 lb)
Weight with stand assembly and cables	6.70 kg (14.78 lb)

<b>Description</b>	<b>Value</b>
Weight without stand assembly (For wall mount or VESA mount considerations - no cables)	4.30 kg (9.48 lb)
Weight of stand assembly	2 kg (4.41 lb)
Front frame gloss	5.5 ± 1.5 gu

## Environmental characteristics

<b>Description</b>	<b>Value</b>
<b>Compliant standards</b>	
<ul style="list-style-type: none"> <li>▪ RoHS-compliant</li> <li>▪ BFR/PVC Reduce monitor (The circuit boards are made from BFR/PVC-free laminates)</li> <li>▪ Arsenic-free glass and mercury-free for the panel only</li> </ul>	
<b>Temperature:</b>	
Operating	0°C to 40°C (32°F to 104°F)
Non-operating	<ul style="list-style-type: none"> <li>▪ Storage: -20°C to 60°C (-4°F to 140°F)</li> <li>▪ Shipping: -20°C to 60°C (-4°F to 140°F)</li> </ul>
<b>Humidity:</b>	
Operating	10% to 80% (non-condensing)
Non-operating	<ul style="list-style-type: none"> <li>▪ Storage: 5% to 90% (non-condensing)</li> <li>▪ Shipping: 5% to 90% (non-condensing)</li> </ul>
<b>Altitude:</b>	
Operating	5,000 m (16,404 ft) (maximum)
Non-operating	12,192 m (40,000 ft) (maximum)
<b>Thermal dissipation</b>	<ul style="list-style-type: none"> <li>▪ 443.6 BTU/Hour (Maximum)</li> <li>▪ 94.2 BTU/Hour (On mode)</li> </ul>

# Pin assignments

## DisplayPort connector

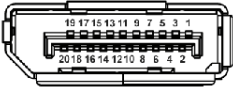

Pin number	20-pin side of the connected signal cable
1	ML3 (n)
2	GND
3	ML3 (p)
4	ML2 (n)
5	GND
6	ML2 (p)
7	ML1 (n)
8	GND
9	ML1 (p)
10	ML0 (n)
11	GND
12	ML0 (p)
13	GND
14	GND
15	AUX (p)
16	GND
17	AUX (n)
18	Hot Plug Detect
19	Re-PWR
20	+3.3 V DP_PWR

## HDMI connector

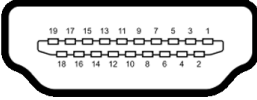

Pin number	19-pin side of the connected signal cable
1	TMDS DATA 2+
2	TMDS DATA 2 SHIELD
3	TMDS DATA 2-
4	TMDS DATA 1+
5	TMDS DATA 1 SHIELD
6	TMDS DATA 1-
7	TMDS DATA 0+
8	TMDS DATA 0 SHIELD
9	TMDS DATA 0-
10	TMDS CLOCK+
11	TMDS CLOCK SHIELD
12	TMDS CLOCK-
13	CEC
14	Reserved (N.C. on device)
15	DDC CLOCK (SCL)
16	DDC DATA (SDA)
17	DDC/CEC Ground
18	+5 V POWER
19	HOT PLUG DETECT



## Universal Serial Bus (USB) interface

This section provides information about the USB ports that are available on the monitor.

**NOTE:** This monitor is SuperSpeed USB 5 Gbps (USB 3.2 Gen 1) compatible.

### Super speed USB 5 Gbps (USB 3.2 Gen 1)

Transfer speed	Data rate	Power consumption*
Super-Speed	5 Gbps	4.50 W (maximum each port)
High speed	480 Mbps	4.50 W (maximum each port)
Full speed	12 Mbps	4.50 W (maximum each port)

### USB Type-C

USB Type-C	Description
Data	SuperSpeed USB 5 Gbps (USB 3.2 Gen 1)
Power charging	Up to 15 W

\*Up to 3 A on USB-C downstream port (with  battery icon) with battery charging version-compliant devices or normal USB devices.

### USB 3.2 Gen 1 (5 Gbps) upstream connector

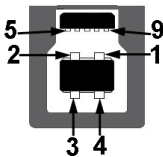

Pin number	Signal name
1	VBUS
2	D-
3	D+
4	GND
5	StdB_SSTX-
6	StdB_SSTX+
7	GND_DRAIN

Pin number	Signal name
8	StdB_SSRX-
9	StdB_SSRX+
Shell	Shield

### USB 3.2 Gen 1 (5 Gbps) downstream connector



Pin number	Signal name
1	VBUS
2	D-
3	D+
4	GND
5	StdA_SSRX-
6	StdA_SSRX+
7	GND_DRAIN
8	StdA_SSTX-
9	StdA_SSTX+
Shell	Shield

### USB Type-C connector

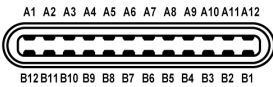



Pin number	Signal name	Pin number	Signal name
<b>A1</b>	GND	<b>B1</b>	GND
<b>A2</b>	TX1+	<b>B2</b>	TX2+
<b>A3</b>	TX1-	<b>B3</b>	TX2-
<b>A4</b>	VBUS	<b>B4</b>	VBUS
<b>A5</b>	CC1	<b>B5</b>	CC2
<b>A6</b>	D+	<b>B6</b>	D+

Pin number	Signal name	Pin number	Signal name
<b>A7</b>	D-	<b>B7</b>	D-
<b>A8</b>	SBU1	<b>B8</b>	SBU2
<b>A9</b>	VBUS	<b>B9</b>	VBUS
<b>A10</b>	RX2-	<b>B10</b>	RX1-
<b>A11</b>	RX2+	<b>B11</b>	RX1+
<b>A12</b>	GND	<b>B12</b>	GND

## USB ports

Port	Location
1 x Type-B upstream	Rear
2 x Type-A downstream	Rear
1 x Type-A downstream	Bottom
1 x Type-C downstream	Bottom
Power charging port - the port with  icon; supports up to 3 A fast-charging capability if the device is BC1.2 compatible	

-  **NOTE: SuperSpeed USB 5 Gbps (USB 3.2 Gen 1) functionality requires a SuperSpeed USB 5 Gbps (USB 3.2 Gen 1)-capable computer.**
-  **NOTE: The USB ports on the monitor work only when the monitor is turned on or in Standby mode. If you turn off the monitor and then turn it on, the attached devices may take a few seconds to resume normal functionality.**

## Plug-and-Play capability

You can connect the monitor to any Plug-and-Play compatible computer. The monitor automatically provides the computer with its Extended Display Identification Data (EDID) using Display Data Channel (DDC) protocols so that the computer can configure itself and optimize the monitor settings. Most monitor installations are automatic; you can select different settings as required. For more information about changing the monitor settings, see [Operating the monitor](#).

## QD-OLED monitor quality and pixel policy

During the QD-OLED monitor manufacturing process, it is not uncommon for one or more pixels to become fixed in an unchanging state which are hard to see and do not affect the display quality or usability. For more information on Dell Monitor Quality and Pixel Policy, see [www.dell.com/pixelguidelines](http://www.dell.com/pixelguidelines).

## Ergonomics

△ **CAUTION: Improper or prolonged usage of keyboard may result in injury.**

△ **CAUTION: Viewing the monitor screen for extended periods of time may result in eye strain.**

For comfort and efficiency, observe the following guidelines when setting up and using your computer workstation:

- Position your computer so that the monitor and keyboard are directly in front of you as you work. Special shelves are commercially available to help you correctly position your keyboard.
- To reduce the risk of eye strain and neck, arm, back, or shoulder pain from using the monitor for long period, we recommend you to:
  1. Set the distance of the screen between 20 to 28 in. (50 - 70 cm) from your eyes.
  2. Blink frequently to moisten your eyes or wet your eyes with water after prolonged usage of the monitor.
  3. Take regular and frequent breaks for 20 minutes every two hours.
  4. Look away from your monitor and gaze at a distant object that is 20 feet away for at least 20 seconds during the breaks.
  5. Perform stretches to relieve tension in the neck, arm, back, and shoulders during the breaks.
- Ensure that the monitor screen is at eye level or slightly lower when you are sitting in front of the monitor.
- Adjust the tilt of the monitor, its contrast, and brightness settings.
- Adjust the ambient lighting around you (such as overhead lights, desk lamps, and the curtains or blinds on nearby windows) to minimize reflections and glare on the monitor screen.
- Use a chair that provides good lower-back support.
- Keep your forearms horizontal with your wrists in a neutral, comfortable position while using the keyboard or mouse.
- Always leave space to rest your hands while using the keyboard or mouse.

- Let your upper arms rest naturally on both sides.
- Ensure that your feet are resting flat on the floor.
- When sitting, make sure that the weight of your legs is on your feet and not on the front portion of your seat. Adjust your chair's height or use a footrest if necessary, to maintain a proper posture.
- Vary your work activities. Try to organize your work so that you do not have to sit and work for extended periods of time. Try to stand or get up and walk around at regular intervals.
- Keep the area under your desk clear of obstructions and cables or power cords that may interfere with comfortable seating or present a potential trip hazard.

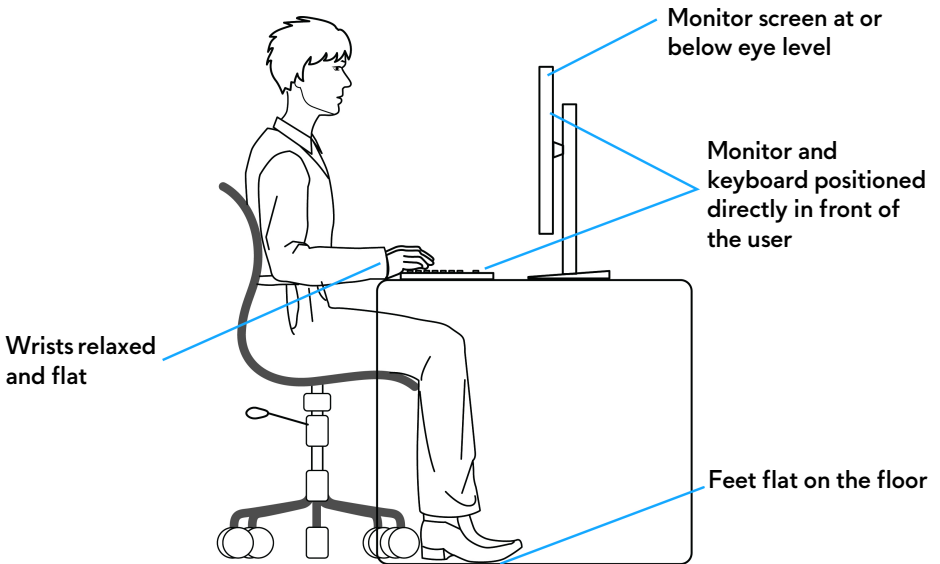

## Handling and moving your display

To ensure that the monitor is handled safely when lifting or moving it, follow these guidelines:

- Before moving or lifting the monitor, turn off your computer and the monitor.
- Disconnect all cables from the monitor.
- Place the monitor in the original box with the original packing materials.
- Hold the bottom edge and the side of the monitor firmly without applying excessive pressure when lifting or moving the monitor.

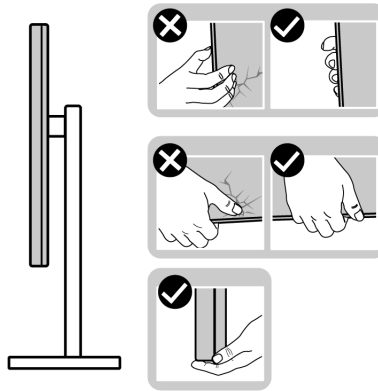

- When lifting or moving the monitor, ensure the screen is facing away from you and do not press on the display area to avoid any scratches or damage.

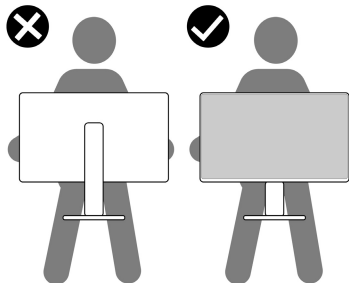

- When transporting the monitor, avoid any sudden shock or vibration to it.

- When lifting or moving the monitor, do not turn the monitor upside down while holding the stand base or stand riser. This may result in accidental damage to the monitor or cause personal injury.

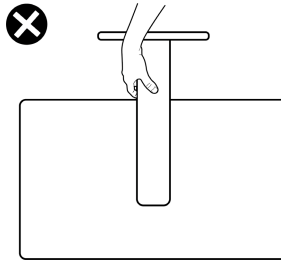

## Maintenance guidelines

### Cleaning your monitor

△ **CAUTION:** Read and follow the [Safety instructions](#) before cleaning the monitor.



⚠ **WARNING:** Before cleaning the monitor, unplug the monitor power cable from the electrical outlet.

For best practices, follow the instructions in the list below when unpacking, cleaning, or handling your monitor:

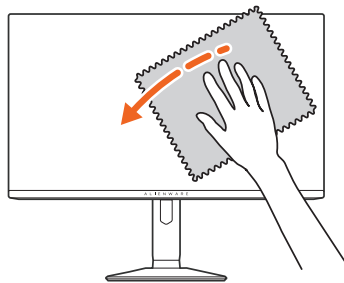
- Use a clean cloth that is slightly dampened with water to clean the stand assembly, the screen, and the chassis of your Dell monitor. If available, use a screen-cleaning tissue or solution suitable for cleaning Dell monitors.
- After cleaning the surface of the table, ensure that it is thoroughly dry and free from any moisture or cleaning agent before placing your Dell monitor on it.
- Using available dry cloth, gently wipe the film surface in one direction at a time to remove stains and dust.



- △ **CAUTION: Do not use detergents or other chemicals such as benzene, thinner, ammonia, abrasive cleaners, alcohol, or compressed air.**
- △ **CAUTION: Using chemicals for cleaning may cause changes in the appearance of the monitor, such as color fading, milky film on the monitor, deformation, uneven dark shade, and peeling of screen area.**

<b>Cleaner</b>	
<b>Do use</b> 	<ul style="list-style-type: none"> <li>▪ Filtered or distilled water</li> <li>▪ Neutral or alkali detergent (for example, dish soap) with water</li> <li>▪ LCD/LED screen cleaner (without Acetone)</li> </ul>
<b>Don't use</b> 	<ul style="list-style-type: none"> <li>▪ Toluene/Acetone/Solvent</li> <li>▪ Common glass cleaner</li> <li>▪ Household cleaning products</li> <li>▪ Abrasive cleaning solution</li> <li>▪ Cleaner containing hydrogen peroxide</li> </ul>

⚠ **WARNING: Do not spray the cleaning solution or even water directly on the surface of the monitor. Doing so will allow liquids to accumulate at the bottom of the display panel and corrode the electronics resulting in permanent damage. Instead, apply the cleaning solution or water to a soft cloth and then clean the monitor.**

 **NOTE: Monitor damage due to improper cleaning methods and the use of benzene, thinner, ammonia, abrasive cleaners, alcohol, compressed air, detergent of any kind will lead to a Customer Induced Damage (CID). CID is not covered under the standard Dell warranty.**

- If you notice white residual powder when you unpack your monitor, wipe it off with a cloth.
- Handle your monitor with care as a darker-colored monitor may get scratched and show white scuff marks more than a lighter-colored monitor.
- To help maintain the best image quality on your monitor, use a dynamically changing screen saver and turn off your monitor when not in use.



# Setting up the monitor

## Attaching the stand

 **NOTE:** The stand assembly is not pre-installed when the monitor is shipped from the factory.

 **NOTE:** The following instructions are applicable only for the stand that was shipped with your monitor. If you are attaching a stand that you purchased from any other source, follow the setup instructions that are included with the stand.

 **CAUTION:** The following steps are important to protect your screen. Follow the instructions to complete the installation.

1. Remove the stand riser, stand base, and I/O cover from the packaging cushion.

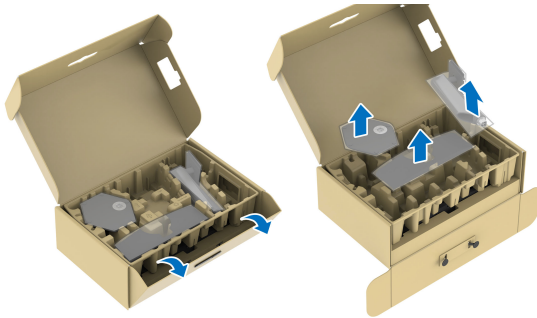

 **NOTE:** The images are for the purpose of illustration only. The appearance of the package cushion may vary.

2. Align and place the stand riser on the stand base.
3. Open the screw handle at the bottom of the stand base and turn it clockwise to secure the stand assembly.
4. Close the screw handle.

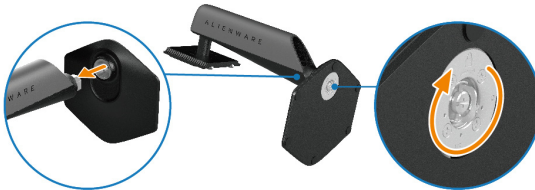

5. Open the protective cover on the monitor to access the VESA slot on the display back-cover.



**NOTE:** Before attaching the stand assembly to the display, ensure that the front plate flap is fully opened to allow space for assembly.

6. Carefully insert the tabs on the stand riser into the slots on the display back-cover and press down the stand assembly to snap it into place.

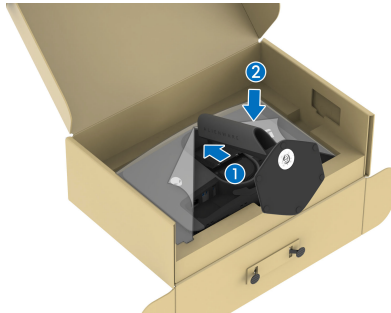

7. Hold the stand riser and lift the monitor carefully, then place it on a flat surface.



**CAUTION:** Hold the stand riser firmly when lifting the monitor to avoid any accidental damage.

8. Lift the protective cover from the monitor.

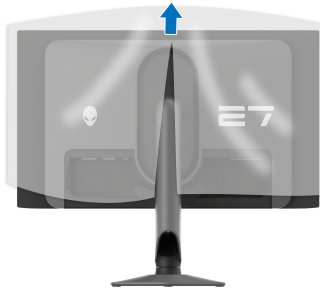

9. Connect the power cable to the monitor.

10. Route the power cable through the cable-management slot on the stand and through the cable-management clips behind the display.

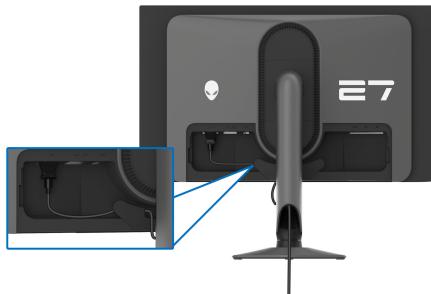

11. Connect the required cables to the monitor, such as DisplayPort-DisplayPort cable, USB-C-DisplayPort cable, HDMI cable, USB 3.2 Gen 1 (5 Gbps) upstream and downstream cables, and so on.

**NOTE:** The HDMI cable and the USB 3.2 Gen 1 (5 Gbps) downstream cables are not shipped with your display and sold separately.

**NOTE:** Dell monitors are designed to work optimally with the Dell-supplied cables inside the box. Dell does not guarantee the video quality and performance if non-Dell cables are used.

12. Route the required cables through the cable-management slot on the stand.



- **NOTE:** Route each cable neatly so that the cables are organized before the I/O cover is attached.
- △ **CAUTION:** Do not plug the power cable into the wall outlet or turn on the monitor until you are instructed to do so.
- **NOTE:** If you want to secure your monitor to a table using the Kensington lock, connect the Kensington lock cable to the **Security-lock slot** at this step. For more information about using the Kensington lock (sold separately), see the documentation that is shipped with the lock. The following image is for the purpose of illustration only. The appearance of the lock may vary.

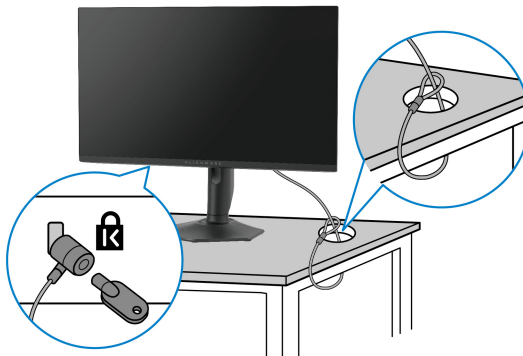

- Slide the tabs on the I/O cover into the slots on the display back cover until it snaps into place.

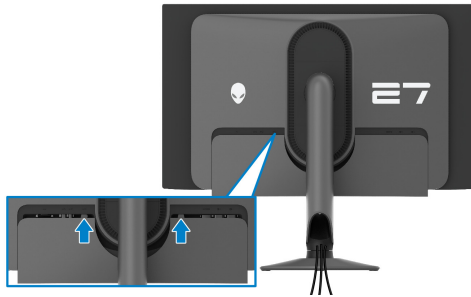

- NOTE:** Ensure that all cables pass through the I/O cover and cable-management slot on the stand riser.

## Connecting the computer

- WARNING:** Before you begin any of the procedures in this section, follow the [Safety instructions](#).

- NOTE:** Do not connect all the cables to the computer at the same time.

- NOTE:** The images are for the purpose of illustration only. The appearance of the computer may vary.

- Connect the other end of the DisplayPort-DisplayPort/USB-C-DisplayPort/HDMI cable to your computer.
- Connect the other end of the USB 3.2 Gen 1 upstream cable to an appropriate USB 3.2 Gen 1 port on your computer.
- Connect the USB peripherals to the SuperSpeed USB 5 Gbps (USB 3.2 Gen 1) downstream ports at the bottom of the monitor.
- Plug the power cables of your computer and monitor into a wall outlet.
- Turn on the monitor and the computer.

If your monitor displays an image, installation is complete. If it does not display an image, see [Common problems](#).

## Connecting the DisplayPort (DP to DP) cable

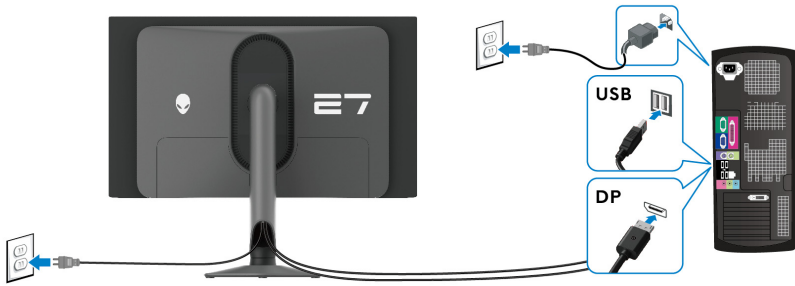

## Connecting the USB-C to DP cable

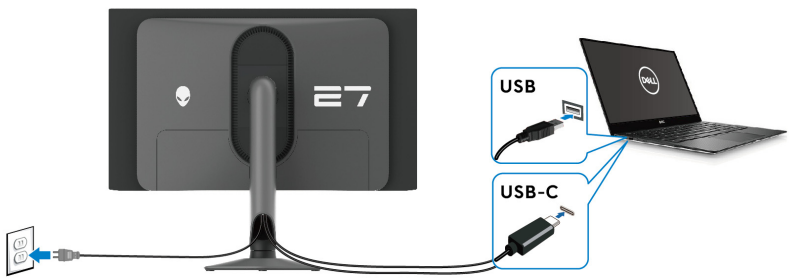

**NOTE:** Connect the USB-C end of the cable to the computer.

## Connecting the HDMI cable (optional)

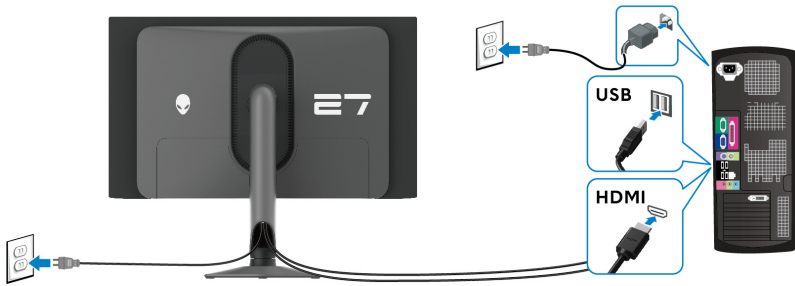

## Removing the monitor stand

- ✎ **NOTE:** To prevent scratches on the screen when removing the stand, ensure that the monitor is placed on a soft surface and handle it carefully.
- ✎ **NOTE:** The following steps are specifically for removing the stand that is shipped with your monitor. If you are removing a stand that you purchased from any other source, follow the setup instructions that are included with the stand.

To remove the stand:

1. Turn off the monitor.
2. Disconnect all the cables from the computer.
3. Place the monitor on a soft cloth or cushion.
4. Carefully slide and remove the I/O cover from the monitor.



5. Disconnect the cables from the monitor and slide them out through the cable-management slot on the stand riser.

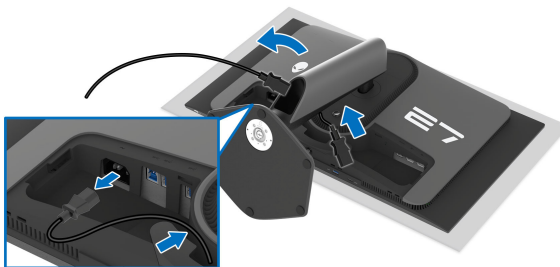

6. Press and hold the stand release button at the back of the display.

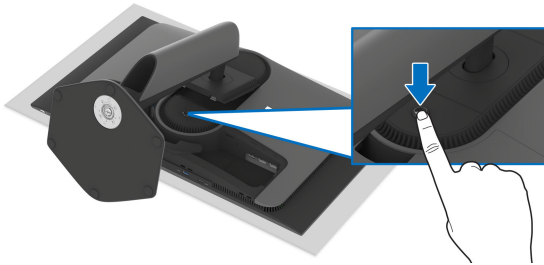

7. Lift the stand assembly up and away from the monitor.





## VESA wall mounting (optional)

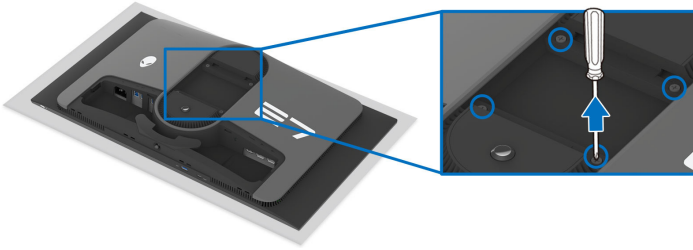

**NOTE:** Use M4 x 10 mm screws to connect the monitor to the wall-mounting kit.

Refer to the instructions that come with the VESA-compatible wall-mounting kit.

1. Place the monitor panel on a soft cloth or cushion on a stable flat surface.
2. Remove the monitor stand. (See [Removing the monitor stand.](#))
3. Use a Phillips crosshead screwdriver to remove the four screws securing the plastic cover.
4. Attach the mounting bracket from the wall-mounting kit to the monitor.
5. Mount the monitor on the wall. For more information, see the documentation that shipped with the wall-mounting kit.

**NOTE:** For use only with UL or CSA or GS-listed wall mount bracket with minimum weight or load bearing capacity of 17.20 kg.

# Operating the monitor

## Turn on the monitor

Press the power button to turn on the monitor.

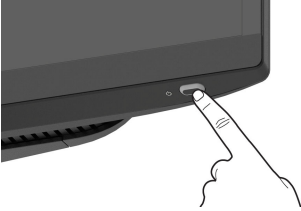



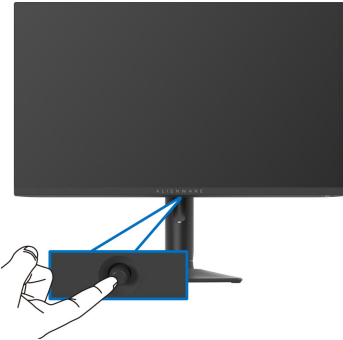

## Using the joystick

Use the joystick at the bottom of the monitor to make On-Screen Display (OSD) adjustments.



1. Press the joystick or move it back/left/right to launch the Menu Launcher.
2. Move the joystick forward/back/left/right to toggle through the options.
3. Press the joystick again to confirm the settings and exit.

Joystick	Description
	<ul style="list-style-type: none"><li>▪ When the OSD menu is on, press the joystick to confirm the selection or save the settings.</li><li>▪ When the OSD menu is off, press the joystick to launch the Menu Launcher. See <a href="#">Accessing the Menu Launcher</a>.</li></ul>

Joystick	Description
	<ul style="list-style-type: none"> <li>For 4-way (left, right, forward, and back) directional navigation.</li> <li>Toggles through the menu items.</li> <li>Increases or decreases the parameters of selected menu item.</li> </ul>
	Selects and enters the submenu.
	Returns to the upper-level menu or exits from the current menu.
	By default, when the OSD menu is off, moving the joystick towards you will toggle through the preset options of <b>AlienVision Toggle List</b> and <b>Off</b> .

## Using the On-Screen Display (OSD) menu

### Accessing the Menu Launcher

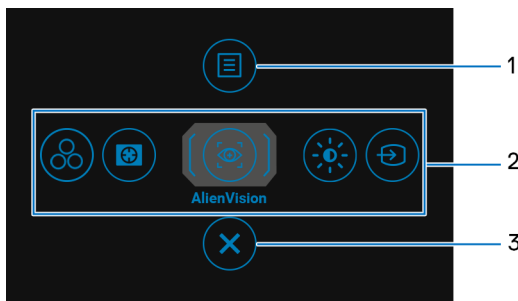

When you move or press the joystick, the Menu Launcher appears at the bottom center of the screen, allowing you to access the OSD menu and shortcut functions.

To select a function, move the joystick.



The following table describes the Menu Launcher functions:

Label	Icon	Description
1	 <b>Menu</b>	To launch the OSD main menu, see <a href="#">Accessing the menu system</a> .

Label	Icon	Description
2	 <p><b>Shortcut functions</b></p>	<p>When you move the joystick to the left or right to toggle through the shortcut functions, the selected item will be highlighted and shifted to the center position. Press the joystick to enter its submenu and make adjustments by moving the joystick.</p> <ul style="list-style-type: none"> <li>▪ <b>Preset Modes:</b> To choose a preferred color mode from the list of preset modes.</li> <li>▪ <b>Dark Stabilizer:</b> To access the <b>Dark Stabilizer</b> adjustment slider.</li> <li>▪ <b>AlienVision:</b> To choose a preferred display mode for gameplay or turn off <b>AlienVision</b>.</li> <li>▪ <b>Brightness/Contrast:</b> To access the adjustment sliders of brightness and contrast.</li> <li>▪ <b>Input Source:</b> To choose an input source from the list of video signals that may be connected to your monitor.</li> </ul> <p> <b>NOTE: You can set your preferred shortcut keys. For more information, see <a href="#">Personalize</a>.</b></p>
3	 <p><b>Exit</b></p>	To exit the Menu Launcher.

When the Menu Launcher is on, the OSD Status Bar appears at the top in the center of the screen, displaying the current settings of some OSD functions.

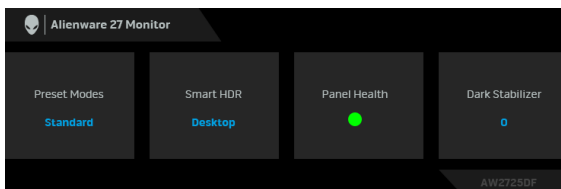

Normally, **Panel Health** displays a green dot. When a yellow dot is displayed, **Pixel Refresh** is suggested to be performed; when a red dot is displayed, it indicates that the monitor has been used for 9000 hours without performing **Panel Refresh**. For more information, see [OLED Panel Maintenance](#).

## Accessing the menu system

After you change the settings, press the joystick to save the changes before proceeding to another menu or exiting the OSD menu.

 **NOTE: To exit the current menu item and return to the previous menu, move the joystick to the left.**

Icon	Menu and submenu	Description
	<b>Game</b>	Use this menu to personalize your visual gameplay experience.

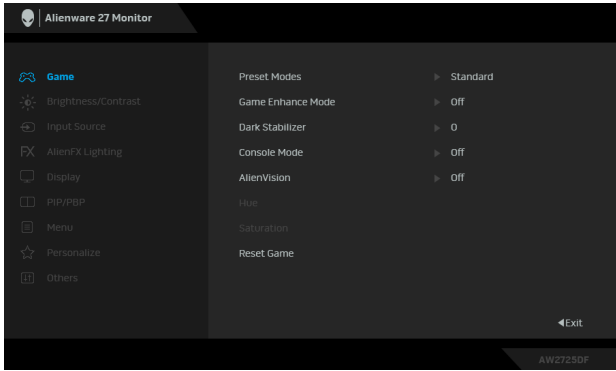

The screenshot shows the 'Alienware 27 Monitor' OSD menu. The 'Game' menu item is selected and highlighted in blue. The submenu options are: Preset Modes (Standard), Game Enhance Mode (Off), Dark Stabilizer (0), Console Mode (Off), AlienVision (Off), Hue, Saturation, and Reset Game. An 'Exit' button is visible at the bottom right.

**Preset Modes** Allows you to choose a preset color mode or create your own color modes.

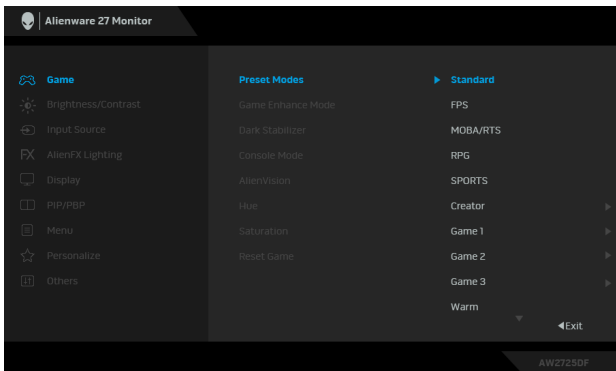

- **Standard:** Loads the monitor's default color settings. This is the default preset mode.

Icon	Menu and submenu	Description
	<b>Preset Modes</b>	<ul style="list-style-type: none"> <li>▪ <b>FPS:</b> Loads color settings ideal for First-Person Shooter (FPS) games.</li> <li>▪ <b>MOBA/RTS:</b> Loads color settings ideal for Multiplayer Online Battle Arena (MOBA) and Real-Time Strategy (RTS) games.</li> <li>▪ <b>RPG:</b> Loads color settings ideal for Role-Playing Games (RPG).</li> <li>▪ <b>SPORTS:</b> Loads color settings ideal for sports games.</li> <li>▪ <b>Creator:</b> Allows you to set <b>Color Space</b> to <b>sRGB</b> or <b>DCI-P3</b> and adjust the <b>Gamma</b> level (between 1.8 and 2.6).</li> <li>▪ <b>Game 1/Game 2/Game 3:</b> Enables you to customize the settings of <b>Gain, Offset, Hue, Saturation,</b> and <b>Dark Stabilizer</b> for your gaming needs.</li> <li>▪ <b>Warm:</b> Presents colors at lower color temperatures. The screen appears warmer with a red/yellow tint.</li> <li>▪ <b>Cool:</b> Presents colors at higher color temperatures. The screen appears cooler with a blue tint.</li> <li>▪ <b>Custom Color:</b> Enables you to manually adjust the color settings. Use the joystick to adjust <b>Gain, Offset, Hue,</b> and <b>Saturation</b> to create your own preset color modes.</li> </ul> <p>✎ <b>NOTE: The feature is disabled when Console Mode is on.</b></p> <p>✎ <b>NOTE: The feature is disabled when Smart HDR is activated and HDR content is displayed.</b></p>

---

**Icon****Menu and submenu****Description**

---

**Game Enhance Mode**

The feature offers three functions to enhance your gameplay experience.

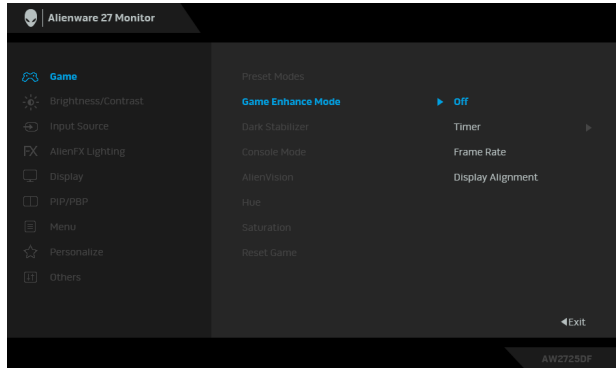

- **Off:** To disable the functions under **Game Enhance Mode**.
  - **Timer:** To display the timer in the upper left corner of the screen, select a time interval from the list. The timer shows the time elapsed since the game started. Available time intervals include **30 min, 40 min, 50 min, 60 min, and 90 min**. This helps you stay informed of the remaining time.
  - **Frame Rate:** To display the current frames per second when playing games. The higher the rate, the smoother the motion appears.
  - **Display Alignment:** To help ensure the perfect alignment of the video contents from multiple displays. Pressing the joystick again will exit the **Display Alignment** mode.
-

Icon	Menu and submenu	Description
------	------------------	-------------



### Dark Stabilizer

The feature improves the visibility in the dark gaming scenarios. The higher the value (between 0 to 3), the better visibility in the dark area of the display image.

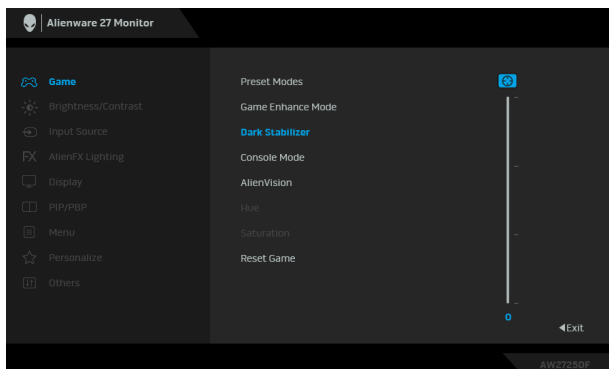

**NOTE:** The feature is disabled when Smart HDR is activated and HDR content is displayed.

**Console Mode** Adjusts **Console Mode** to **On/Off**, **Color**, **Gamma**, or **Source Tone Map**. Activating the feature gives the best gaming experience when playing console games. For more information, see **Console mode (HDMI only)**.

- **On/Off:** Select to disable the functions under **Console Mode**.
- **Color:** RGB default 100, and this mode can adjust RGB from 0 - 100.
- **Gamma:** **Gamma** default is at center 2.2. Selecting this feature enables you to manually adjust **Gamma** from 1.8 - 2.6.
- **Source Tone Map:** Select to allow the HDR content to be tone mapped by the source device.

**NOTE:** **Console Mode is only for HDMI. Preset modes are not available when Console Mode is turned "On".**



Icon	Menu and submenu	Description
------	------------------	-------------



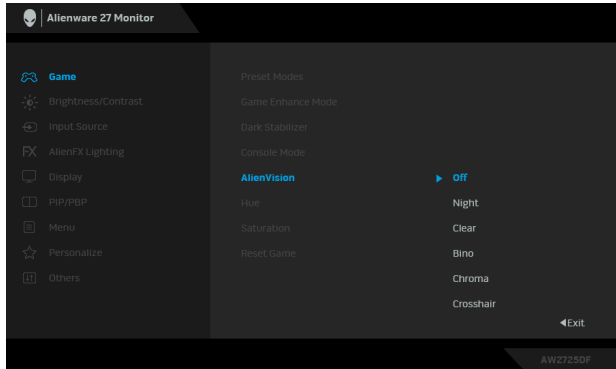

**AlienVision**

**AlienVision** provides a few display modes for gaming scenarios. You can go through the options to see the preview. The default setting is **Off**.



- **Night**: Identifies the objects clearly in dark game scenes.
- **Clear**: Cleans up visual artifacts to enhance the clarity in the daytime scenes.
- **Bino**: This feature allows you to zoom in on distant objects like a telescope.
- **Chroma**: Applies dynamic heatmaps in various scenes to help distinguish game objects from the background.
- **Crosshair**: Assists in aiming and predictive aiming with markings. Displays the crosshair throughout the game, helping improve aiming in the heat of the game.

 **NOTE: More AlienVision options are available by using Alienware Command Center (AWCC).**

Icon	Menu and submenu	Description
	<b>Hue</b>	<p>This feature can shift the color of the video image to green or purple. This is used to adjust the desired flesh-tone color.</p> <p>Use the joystick to adjust the hue level from 0 to 100. Higher levels increase the green shade of the video image, while lower levels increase the purple shade of the video image.</p> <p> <b>NOTE: This feature is available only when you select FPS, MOBA/RTS, SPORTS, or RPG preset mode.</b></p>
	<b>Saturation</b>	<p>This feature can adjust the color saturation of the video image.</p> <p>Use the joystick to adjust the saturation level from 0 to 100.</p> <p>Higher levels increase the colorful appearance of the video image; while lower levels increase the monochrome appearance of the video image.</p> <p> <b>NOTE: This feature is available only when you select FPS, MOBA/RTS, SPORTS, or RPG preset mode.</b></p>
	<b>Reset Game</b>	<p>Resets all settings under the <b>Game</b> menu to the factory defaults.</p>

Icon	Menu and submenu	Description
------	------------------	-------------



**Brightness/Contrast**

Use this menu to activate **Brightness/Contrast** adjustment.



**Brightness** **Brightness** adjusts the luminance of the backlight. Move the joystick to adjust the brightness level (minimum 0/maximum 100).



 **NOTE: Manual adjustment of Brightness is disabled when Smart HDR is activated and HDR content is displayed.**

**Contrast** Adjust **Brightness** first, and then adjust **Contrast** only if further adjustment is necessary.

Move the joystick to adjust the contrast level (minimum 0/maximum 100).

The **Contrast** feature adjusts the degree of difference between darkness and lightness on the monitor screen.

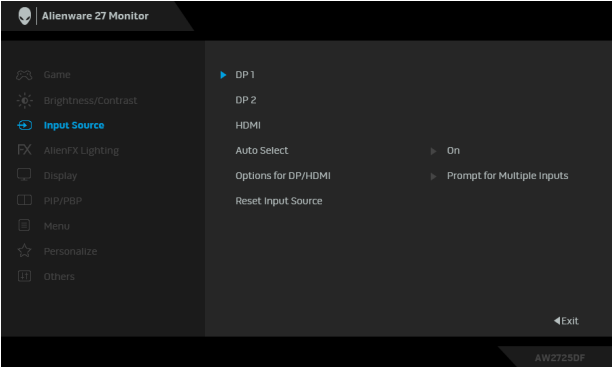
 **NOTE: Manual adjustment of Contrast is disabled when Smart HDR is activated and HDR content is displayed.**

Icon	Menu and submenu	Description
	<b>Input Source</b>	Use this menu to select between the different video signals that may be connected to your monitor.
		
<b>DP 1</b>	<b>DP 2</b>	Select the <b>DP 1</b> or <b>DP 2</b> input when you are using the DisplayPort (DP) connector. Press the joystick to confirm the selection.
<b>HDMI</b>		Select the <b>HDMI</b> input when you are using the HDMI connector. Press the joystick to confirm the selection.
<b>Auto Select</b>		Automatically scans for available input sources. Press the joystick to confirm the selection.
<b>Options for DP/HDMI</b>		<p>Allows you to set this feature to:</p> <ul style="list-style-type: none"> <li>▪ <b>Prompt for Multiple Inputs:</b> Always displays the “Switch to DP/HDMI Video Input” message for you to choose whether to switch or not.</li> <li>▪ <b>Always Switch:</b> Always switches to DP/HDMI video input (without asking) when the DisplayPort or HDMI cable is connected.</li> <li>▪ <b>Off:</b> Never automatically switches to DP/HDMI video input when the DisplayPort or HDMI cable is connected.</li> </ul> <p>Press the joystick to confirm the selection.</p>
	<b>NOTE: This feature is disabled when Auto Select is set to Off.</b>	
<b>Reset Input Source</b>		Resets all settings under the <b>Input Source</b> menu to the factory defaults.

Icon	Menu and submenu	Description
------	------------------	-------------



**AlienFX Lighting**

Adjusts the LED light settings for the Alienware logo, number graphic, and Power button.

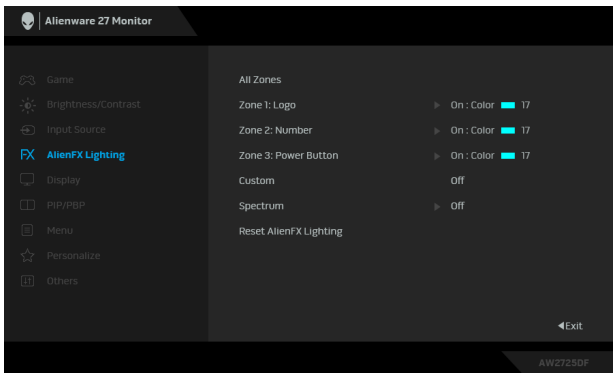

Before making any adjustments, select any or all of these 3 zones from the submenus. The following illustrations indicate the lighting zones.

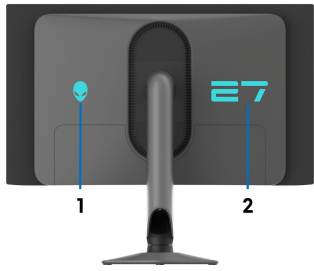

Icon	Menu and submenu	Description
FX	<b>All Zones</b>	To specify an LED lighting color for the selected zone, select <b>On</b> , move the joystick to highlight <b>Custom Color</b> , and press the joystick to enter its submenu.
	<b>Zone 1: Logo</b>	
	<b>Zone 2: Number</b>	
	<b>Zone 3: Power Button</b>	

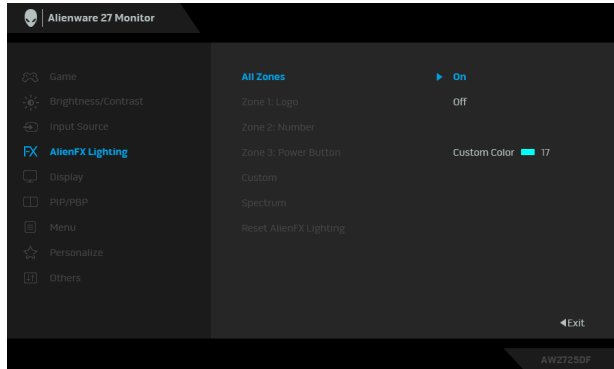

Then move the joystick to make a selection from the list of 20 available colors.

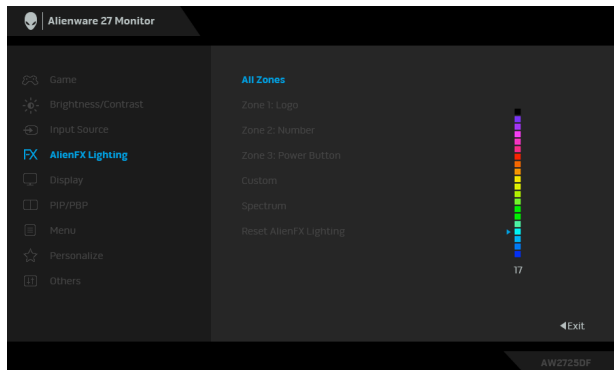

---

**Icon****Menu and  
submenu****Description**

---

**FX**

The following table depicts the color number and the RGB codes used for the 20 LED colors.

No.	R	G	B
1	0	0	0
2	38	0	180
3	51	0	198
4	195	0	195
5	186	16	123
6	194	0	65
7	185	0	0
8	166	51	0
9	185	96	0
10	195	140	0
11	130	219	0
12	62	223	0
13	40	223	0
14	0	195	0
15	0	205	25
16	0	205	45
17	10	230	180
18	0	101	247
19	0	25	247
20	0	0	255

To turn off the light for **All Zones/Zone 1: Logo/Zone 2: Number**, select **Off**.

For **Zone 3: Power Button**, you may specify to turn off the light when the monitor is in on or standby mode.

 **NOTE: These features are available only when Spectrum is disabled.**

---

Icon	Menu and submenu	Description
FX	<b>Custom</b>	It is a read-only menu. When you use <b>Custom Color</b> or <b>Spectrum</b> to make LED lighting adjustments, this menu status shows <b>Off</b> ; when you make the LED lighting adjustments through AlienFX application, the status shows <b>On</b> .
	<b>Spectrum</b>	The default setting is <b>Off</b> . When you select <b>On</b> , the AlienFX lights of 3 zones glow and change colors in the sequence of the color spectrum: red, orange, yellow, green, blue, indigo, and violet.

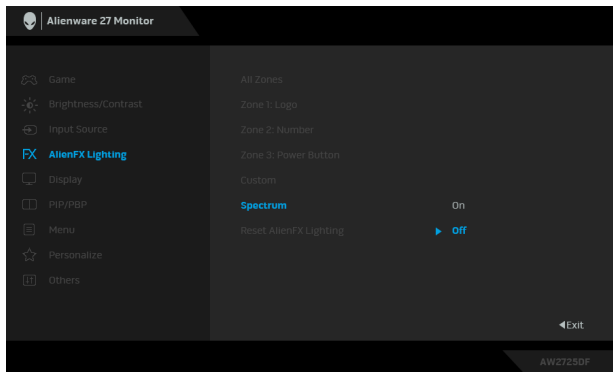

<b>Reset AlienFX Lighting</b>	Resets all settings under the <b>AlienFX Lighting</b> menu to the factory defaults.
-------------------------------	---



Icon	Menu and submenu	Description
------	------------------	-------------



## Display

Use the **Display** menu to adjust the images.

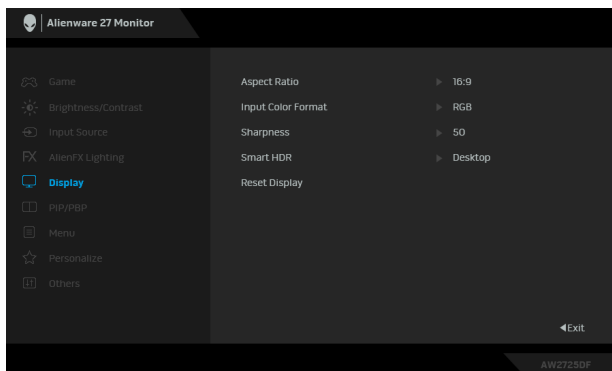

**Aspect Ratio** Adjusts the image ratio to **16:9**, **Auto Resize**, or **4:3**.

 **NOTE: The feature is disabled when PIP/PBP is activated.**

## Input Color Format

Allows you to set the video input mode to:

- **RGB:** Select this option if your monitor is connected to a computer or a media player that supports RGB output.
- **YCbCr:** Select this option if your media player supports only YCbCr output.

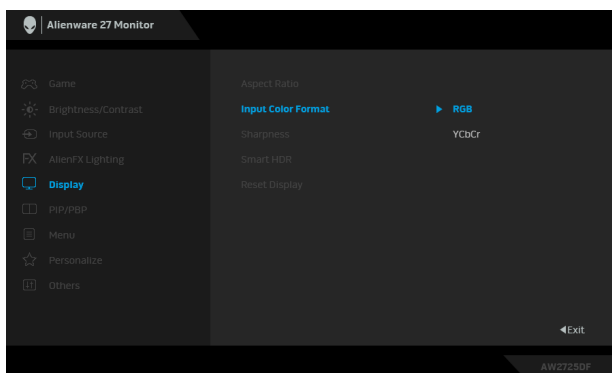

## Sharpness

This feature can make the images look sharper or softer. Move the joystick to adjust the sharpness level from 0 to 100.

Icon	Menu and submenu	Description
------	------------------	-------------



**Smart HDR**

The **Smart HDR** (High Dynamic Range) feature enhances the display output by optimally adjusting contrast and the ranges of color and luminosity to resemble true-to-life visuals.

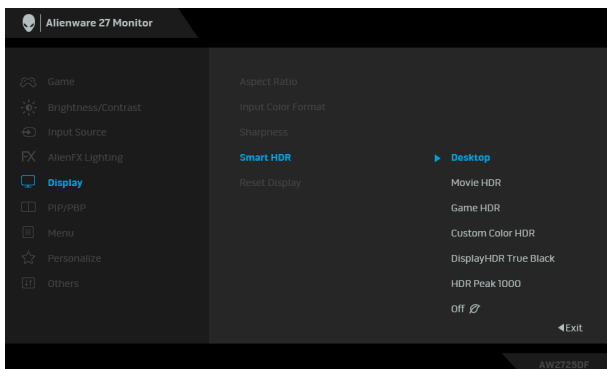

- **Desktop:** Suitable for using the monitor with a desktop computer.
- **Movie HDR:** Suitable for the playback of HDR video content.
- **Game HDR:** Suitable for playing HDR-compatible games. It displays more realistic scenes and makes the gaming experience immersive and entertaining.
- **Custom Color HDR:** Enables you to create your own HDR mode by adjusting the settings of **Contrast**, **Hue**, and **Saturation**.
- **DisplayHDR True Black:** Compliant with the DisplayHDR True Black standard, supporting a peak brightness of 400 cd/m<sup>2</sup>.
- **HDR Peak 1000:** Suitable for playing HDR content with a peak brightness of 1000 cd/m<sup>2</sup>.

You can disable **Smart HDR** by selecting **Off**. Press the joystick to confirm the selection.

Icon	Menu and submenu	Description
------	------------------	-------------



### Smart HDR

- NOTE: When activating and deactivating Smart HDR, a blank screen is expected (about 5 seconds). This is normal behavior as the monitor changes the display mode. Do not power cycle the monitor.**
- NOTE: When the monitor is processing HDR content, Preset Modes, Dark Stabilizer, Brightness, and Contrast are disabled.**
- NOTE: AW2725DF does not support HLG.**
- NOTE: The feature is disabled when PIP/PBP is activated.**

**Reset Display** Resets all settings under the **Display** menu to the factory defaults.



### PIP/PBP

This feature brings up a window displaying images from another input source.

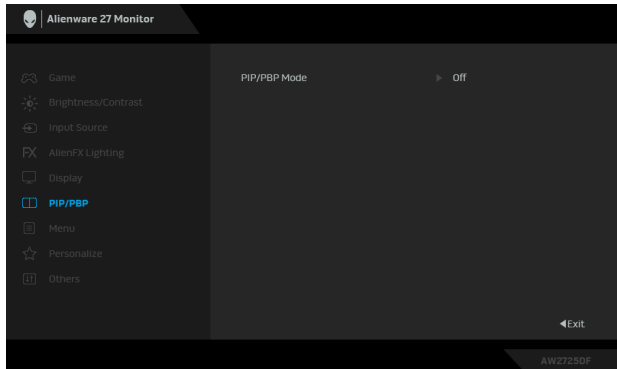

Main Window	Sub-Window		
	DP 1	DP 2	HDMI
DP 1	—	✓	✓
DP 2	✓	—	✓
HDMI	✓	✓	—

- NOTE: In PBP mode, the images are displayed at the center of the split windows.**

Icon	Menu and submenu	Description
------	------------------	-------------





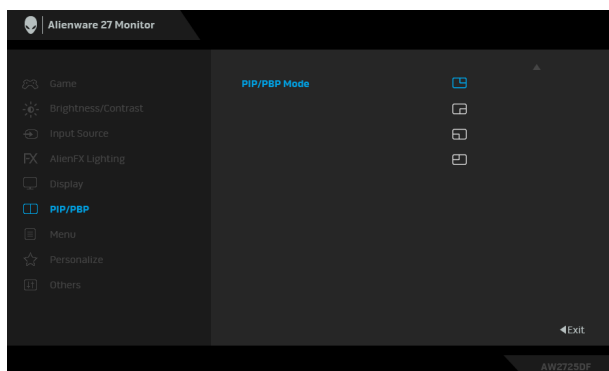
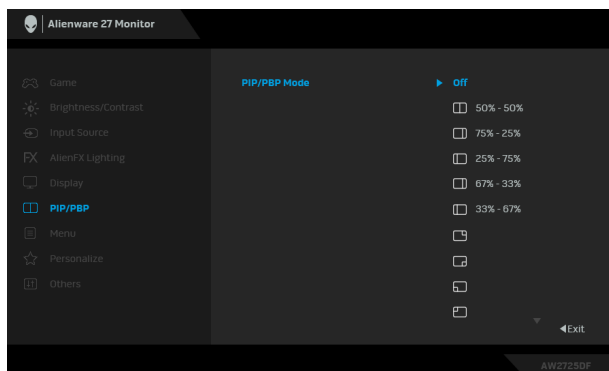

**PIP/PBP Mode** Allows you to choose a PBP or PIP mode from the preset list, which provides different sizes and positions of the sub-window. The options are shown in graphic format, giving a quick understanding of various layout settings. Press the joystick to confirm the selection. The default setting is **Off**.



**PIP/PBP (Sub)** Select between the different video signals that may be connected to your monitor for the PIP/PBP sub-window. Press the joystick to confirm the selection.

 **NOTE: This feature is available only when the PIP/PBP mode is enabled.**

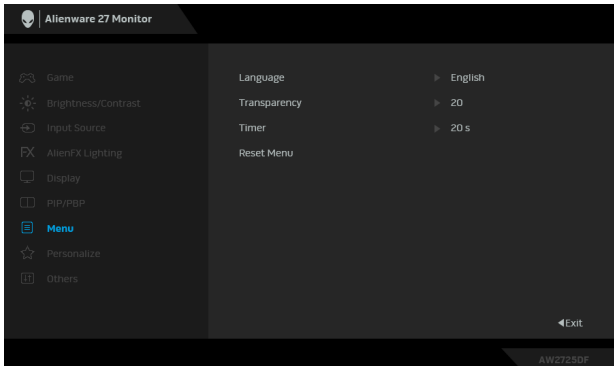
Icon	Menu and submenu	Description
	<b>Video Swap</b>	Select to swap videos between the main window and sub-window in PIP/PBP mode.   <b>NOTE: This feature is available only when the PIP/PBP mode is enabled.</b>
	<b>Contrast (Sub)</b>	Select to adjust the contrast level of the picture in PIP/PBP mode.  Move the joystick to adjust the contrast level from 0 to 100.   <b>NOTE: This feature is available only when the PIP/PBP mode is enabled.</b>
	<b>Menu</b>	Use this menu to adjust the settings of the OSD, such as the languages of the OSD, the amount of time the menu remains on screen, and so on.
		
	<b>Language</b>	Sets the OSD display to one of the eight languages: English, Spanish, French, German, Brazilian Portuguese, Russian, Simplified Chinese, or Japanese.
	<b>Transparency</b>	Move the joystick to change the menu transparency (minimum 0/maximum 100).
	<b>Timer</b>	Sets the length of time for the OSD to remain active after your last operation with the joystick.  Move the joystick to adjust the slider in 1 second increments, from 5 to 60 seconds.
	<b>Reset Menu</b>	Resets all settings under the <b>Menu</b> menu to the factory defaults.

Icon	Menu and submenu	Description
------	------------------	-------------



## Personalize

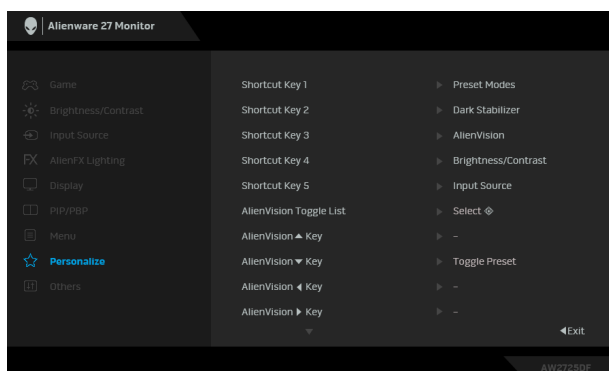

- Shortcut Key 1** Allows you to choose a feature from the provided list and set it as a shortcut key. The list includes **Preset Modes, Game Enhance Mode, Dark Stabilizer, AlienVision, Brightness/Contrast, Input Source, Aspect Ratio, Smart HDR, PIP/PBP Mode, and Video Swap**. Press the joystick to confirm the selection.
- Shortcut Key 2**
- Shortcut Key 3**
- Shortcut Key 4**
- Shortcut Key 5**

## AlienVision Toggle List

Select to specify the preferred modes for **AlienVision** shortcut function in the Menu Launcher and **AlienVision** 4-direction keys. Press the joystick again to select or not select the mode.

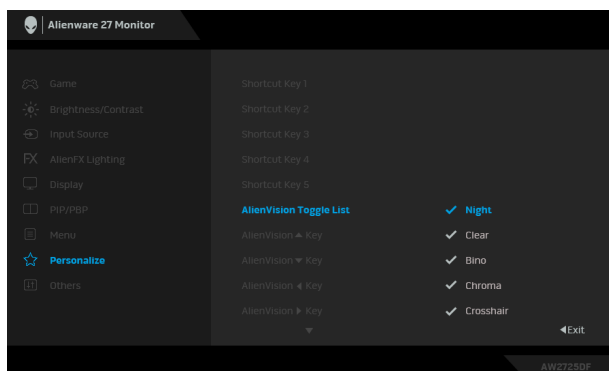

Icon	Menu and submenu	Description
★	<b>AlienVision ▲ Key</b>	You can define the joystick movements for <b>AlienVision</b> preset modes; therefore, when you move the joystick in any specified direction, a particular <b>AlienVision</b> mode is activated. If you select <b>Toggle Preset</b> , you can toggle through the modes specified in <b>AlienVision Toggle List</b> and the <b>Off</b> option. By factory default, the <b>AlienVision ▼ Key</b> is enabled and set to <b>Toggle Preset</b> .
	<b>AlienVision ▼ Key</b>	
	<b>AlienVision ◀ Key</b>	
	<b>AlienVision ▶ Key</b>	
	<b>USB Charging</b>	Allows you to enable or disable USB function during monitor standby mode.

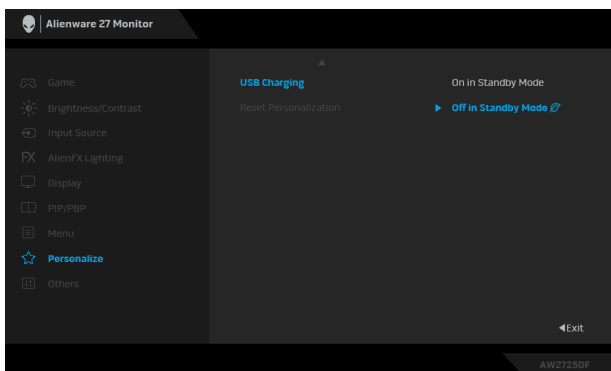

<b>Reset Personalization</b>	Resets all settings under the <b>Personalize</b> menu to the factory defaults.
------------------------------	--

Icon	Menu and submenu	Description
------	------------------	-------------



## Others

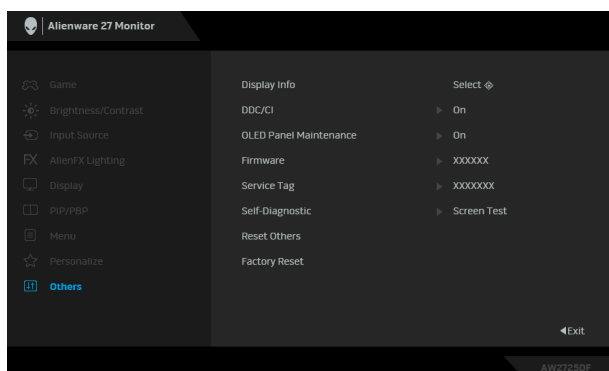

### Display Info

Select to display the monitor's current settings.

### DDC/CI

**DDC/CI** (Display Data Channel/Command Interface) allows your monitor parameters (brightness, color balance, etc.) to be adjustable through the software on your computer. You can disable this feature by selecting **Off**.

Enable this feature for the best user experience and optimum performance of your monitor.

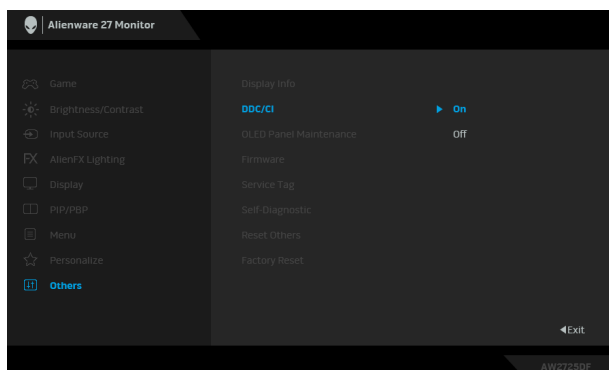



---

**Icon****Menu and submenu****Description**

---

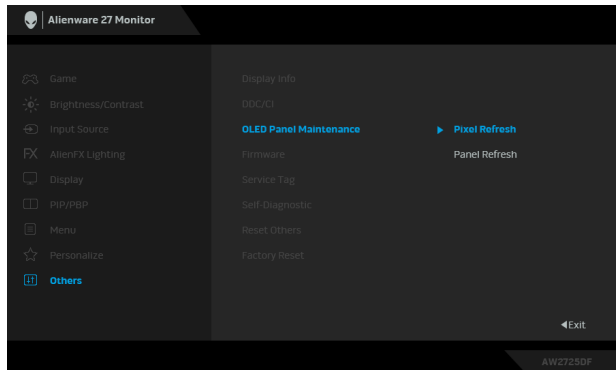
**OLED Panel Maintenance**





The feature prevents the screen from image retention by offering these functions:

- **Pixel Refresh:** To reduce temporary image retention on the screen, you can manually activate this function after using the monitor for a couple of hours. Alternatively, the function is activated automatically when you have used the monitor for 4 hours. The process takes approximately 6 to 8 minutes to complete.

 **NOTE: The power LED indicator blinks slowly in green during the refresh process.**

 **NOTE: If the accumulated usage time exceeds 4 hours, Pixel Refresh will be automatically activated when the monitor goes into Standby mode or when you press the power button to turn off the monitor.**

- **Panel Refresh:** To prevent permanent image retention caused by static content when you use the monitor for 9000 hours, you can manually activate this function to refresh the pixels. Alternatively, the function is activated automatically when the accumulated usage time exceeds the factory default setting (9000 hours). The process takes approximately an hour to complete.
-

Icon	Menu and submenu	Description
	<b>OLED Panel Maintenance</b>	<p> <b>NOTE: The power LED indicator blinks slowly in red during the refresh process.</b></p> <p> <b>NOTE: If the accumulated usage time exceeds 9000 hours, Panel Refresh will be automatically activated when the monitor goes into Standby mode or when you press the power button to turn off the monitor.</b></p> <p> <b>NOTE: To obtain a better performance of Panel Refresh, activate the function within a temperature range of 0°C to 45°C.</b></p>
	<b>Firmware</b>	Displays the firmware version of your monitor.
	<b>Service Tag</b>	Displays the Service Tag of your monitor. The Service Tag is a unique alphanumeric identifier that is required when you contact Dell technical support, access warranty information, search for latest drivers on Dell support website and so on.
	<b>Self-Diagnostic</b>	Use this feature to perform <b>Screen Test</b> or/and <b>Fan Test</b> , see <a href="#">Built-in diagnostics</a> .
	<b>Reset Others</b>	Resets all settings under the <b>Others</b> menu to the factory preset values.
	<b>Factory Reset</b>	Resets all OSD settings to the factory defaults.

## Console mode (HDMI only)

Console Mode is designed with an excellent picture quality at a fast response time and a high frame rate of 120 Hz to give the best console game experience. It can support up to 4K resolution in this QHD monitor.

### Supported timing

Display mode	Horizontal frequency (kHz)	Vertical frequency (Hz)	Pixel clock (MHz)	Sync polarity (Horizontal/Vertical)
640 x 480	31.47	59.94	25.18	-/-
640 x 480	37.50	75	31.50	-/-
720 x 400	31.47	70.08	28.32	-/+
800 x 600	37.88	60.32	40	+/+
800 x 600	46.88	75	49.50	+/+
1024 x 768	48.36	60	65	-/-
1024 x 768	60.02	75.03	78.75	+/+
1152 x 864	67.50	75	108	+/+
1280 x 1024	63.98	60.02	108	+/+
1280 x 1024	79.98	75.03	135	+/+
1600 x 900	60	60	108	+/+
1920 x 1080	67.50	60	148.50	+/+
1920 x 1080	135	120	297	+/+
2560 x 1440	88.79	59.95	241.50	+/-
2560 x 1440	183	120	497.75	+/-
3840 x 2160	112.50	50	594	+/+
3840 x 2160	135	60	594	+/+

## OSD warning message

When the monitor does not support a particular resolution mode, you see the following message:

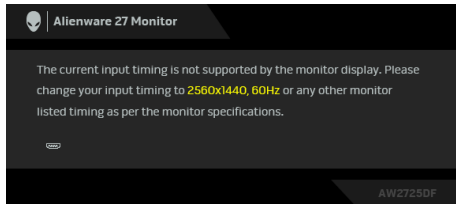

This means that the monitor cannot synchronize with the signal that it is receiving from the computer. See [Monitor specifications](#) for the horizontal and vertical frequency ranges addressable by this monitor. The recommended resolution is **2560 x 1440**.

 **NOTE: The message may be slightly different according to the connected input signal.**

You see the following message before the **DDC/CI** feature is disabled:

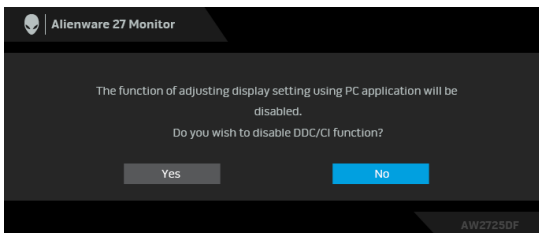

When you adjust the **Brightness** level above the default level for the first time, the following message appears:

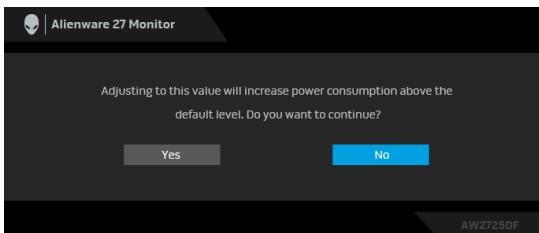

 **NOTE: If you select Yes, the message will not appear the next time you change the Brightness setting.**

When you set **Preset Modes** to **FPS, MOBA/RTS,** or **SPORTS** for the first time, the following message appears:

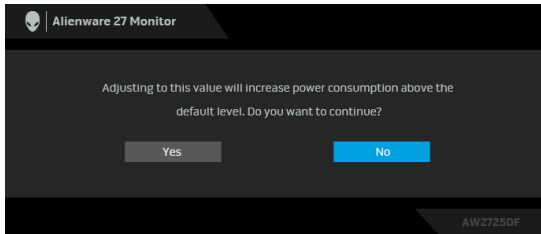

**NOTE:** If you select **No**, the **Brightness** level will be changed to **75%** for these **Preset Modes**.

When you change the default setting of power saving features for the first time, such as **Smart HDR** or **USB Charging**, the following message appears:

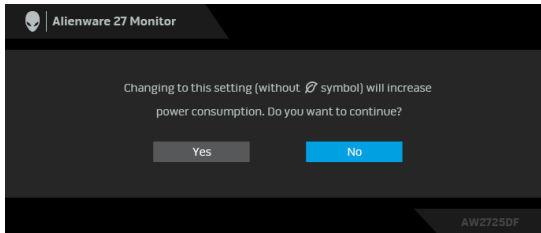

**NOTE:** If you select **Yes** for either of the features mentioned above, the message will not appear the next time you change the settings of these features. When you perform a factory reset, the message will appear again.

When the monitor goes into Standby mode, the following message appears:

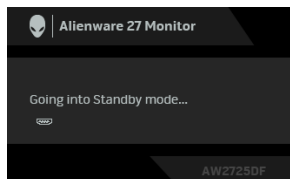

**NOTE:** The message may be slightly different according to the selected input signal.

Activate the computer and wake up the monitor to gain access to the **OSD**.

The OSD functions only in the normal operation mode. If you press the joystick during the Standby mode, the following message will appear depending on the selected input:

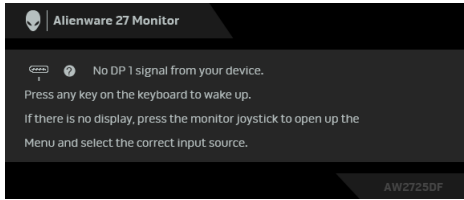

**NOTE: The message may be slightly different according to the connected input signal.**

Activate the computer and wake up the monitor to gain access to the **OSD**.

If **DP 1**, **DP 2**, or **HDMI** input is selected and the corresponding cable is not connected, the following message will appear:

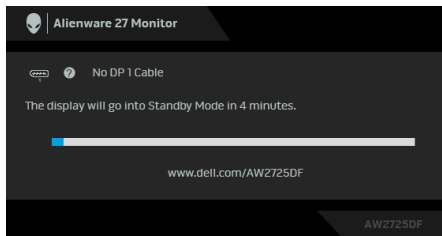

**NOTE: The message may be slightly different according to the selected input signal.**

Activate the computer and wake up the monitor to gain access to the **OSD**.

When **Pixel Refresh** is selected, the following message appears:

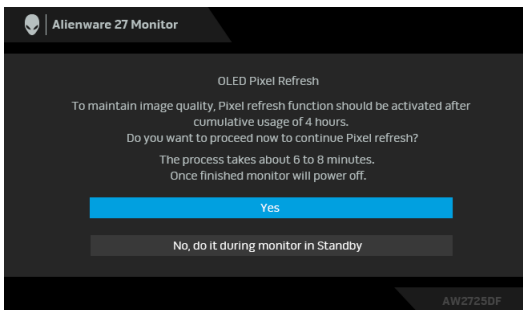

Once you select **Yes**, the monitor will be turned off and the refresh process will

run automatically. The process takes approximately 6 to 8 minutes to complete.

When **Panel Refresh** is selected or the cumulative usage time of the monitor is more than 9000 hours, the following message appears:

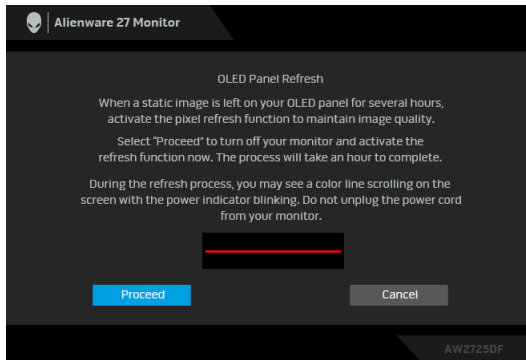

Select **Proceed**, and the refresh process will run automatically. The process takes approximately an hour to complete.

If you press the power button during the process of running **Pixel Refresh** or **Panel Refresh**, the following message appears:

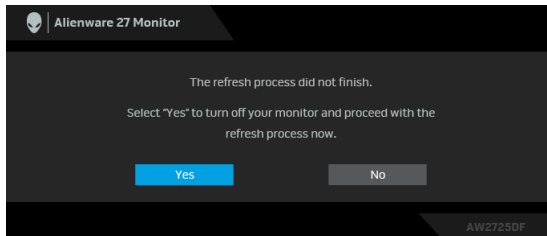

When **Factory Reset** is selected, the following message appears:

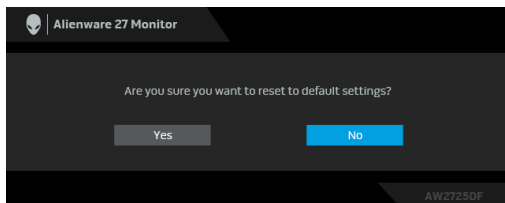

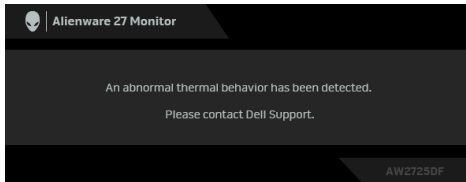

When the built-in thermal sensor detects an abnormality, the following message appears every 30 minutes:



For more information, see [Troubleshooting](#).

## Locking the control buttons

You can lock the monitor control buttons to prevent access to the OSD menu and/or power button.

1. Move and hold the joystick forward/back/left/right for about 4 seconds until a pop-up menu appears.
2. Move the joystick to select one of the following options:
  -  : The OSD menu settings are locked and not accessible.
  -  : The power button is locked.
  -  : The OSD menu settings are not accessible and the power button is locked.
3. Press the joystick to confirm the configuration.

To unlock, move and hold the joystick forward/back/left/right for about 4 seconds until a menu appears on the screen, and then select  to unlock and close the pop-up menu.



## Setting the maximum resolution

 **NOTE:** The steps may vary slightly depending on the version of Windows you have.

To set the maximum resolution for the monitor:

In Windows 8.1:

1. For Windows 8.1, select the Desktop tile to switch to classic desktop.
2. Right-click on the desktop and click **Screen resolution**.
3. If you have more than one monitor connected, ensure that you select **AW2725DF**.
4. Click the **Screen Resolution** dropdown list and select **2560 x 1440**.
5. Click **OK**.

In Windows 10 and Windows 11:

1. Right-click on the desktop and click **Display settings**.
2. If you have more than one monitor connected, ensure to select **AW2725DF**.
3. Click the **Display Resolution** dropdown list and select **2560 x 1440**.
4. Click **Keep changes**.

If you do not see 2560 x 1440 as an option, you must update your graphics driver to the latest version. Depending on your computer, complete one of the following procedures:

If you have a Dell desktop or a laptop:

- Go to [www.dell.com/support](http://www.dell.com/support), enter your service tag, and download the latest driver for your graphics card.

If you are using a non-Dell computer (laptop or desktop):

- Go to the support site for your non-Dell computer and download the latest graphics card drivers.
- Go to the graphics card's website and download the latest graphic card drivers.

## Requirements to view or playback HDR content

### (1) Through Ultra BluRay DVD or Game consoles

Ensure the DVD player or Game console is HDR capable, such as Panasonic DMP-UB900 or PS5.

### (2) Through a PC

Ensure the graphics card used is HDR capable, i.e., it has an HDMI 2.1 (TMDS)(with HDR option) compliant port and HDR graphics driver is installed. HDR capable application program must be used, such as Cyberlink PowerDVD 17, Windows 10 Movies & TV app.

 **NOTE: To download and install the latest graphics driver that supports HDR content playback on your Dell desktop or laptop, see <https://www.dell.com/support/drivers>.**

#### **NVIDIA**

For a full range of HDR capable NVIDIA graphics cards, see [www.nvidia.com](http://www.nvidia.com).

Ensure to download the driver that supports Full Screen Playback mode (e.g. PC games, UltraBluRay players), HDR on Win 10 Redstone 2 OS: 381.65 or later.

#### **AMD**

For a full range of HDR capable AMD graphics cards, see [www.amd.com](http://www.amd.com). Read the HDR driver support information and download the latest driver.

#### **Intel (Integrated Graphics)**

HDR capable processor: CannonLake or later

Suitable HDR player: Windows 10 Movies & TV app

Operating System (OS) with HDR support: Windows 10 Redstone 3

Driver with HDR support: see [downloadcenter.intel.com](http://downloadcenter.intel.com) for the latest HDR driver

 **NOTE: HDR playback through OS (e.g. playback of HDR in a window within desktop) requires Windows 10 Redstone 2 or later with an appropriate application program such as PowerDVD 17. Playing back protected content will require appropriate DRM software and/or hardware, e.g. Microsoft Playready. For support information, see <https://www.support.microsoft.com>.**

## Using the tilt, swivel, pivot and height adjustment

**NOTE:** The following instructions are applicable only for the stand that was shipped with your monitor. If you are attaching a stand that you purchased from any other source, follow the setup instructions that were included with the stand.

### Tilt and swivel adjustment

With the stand attached to the monitor, you can tilt and swivel the monitor for the most comfortable viewing angle.

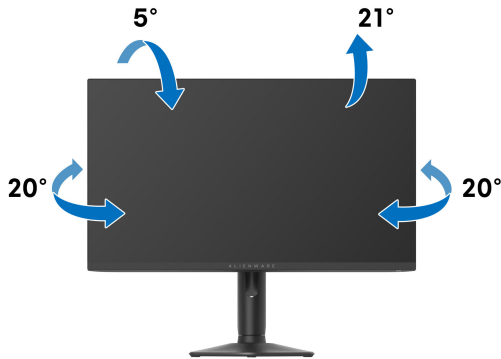

**NOTE:** The stand assembly is not pre-installed when the monitor is shipped from the factory.

### Height adjustment

**NOTE:** The stand extends vertically up to 110 mm. The following image illustrates how to extend the stand vertically.



## Pivot adjustment

Before you rotate the display, ensure it is completely extended vertically and completely tilted up to avoid hitting the bottom edge of the monitor.



## Rotate clockwise



## Rotate counterclockwise



- ✎ **NOTE:** To use the Display Rotation function (Landscape versus Portrait view) with your Dell computer, you require an updated graphics driver that is not included with this monitor. To download the graphics driver, go to [www.dell.com/support](http://www.dell.com/support) and see the Download section for Video Drivers for latest driver updates.
- ✎ **NOTE:** In the Portrait mode, you may experience performance degradation when using graphic-intensive applications such as 3D gaming.

## Adjusting the rotation display settings of your system

After you have rotated your monitor, you need to complete the procedure below to adjust the Rotation Display Settings of your system.

 **NOTE: If you are using the monitor with a non-Dell computer, you need to go to the graphics driver website or your computer manufacturer's website for information on rotating the 'contents' on your display.**

To adjust the Rotation Display Settings:

1. Right-click on the desktop and click **Properties**.
2. Select the **Settings** tab and click **Advanced**.
3. If you have an AMD graphics card, select the **Rotation** tab and set the preferred rotation.
4. If you have an NVIDIA graphics card, click the **NVIDIA** tab, in the left-hand column select **NVRotate**, and then select the preferred rotation.
5. If you have an Intel graphics card, select the **Intel** graphics tab, click **Graphic Properties**, select the **Rotation** tab, and then set the preferred rotation.

 **NOTE: If you do not see the rotation option or it is not working correctly, go to [www.dell.com/support](http://www.dell.com/support) and download the latest driver for your graphics card.**

# Using AlienFX™ function

You can customize advanced features for your monitor through AlienFX™ in the Alienware Command Center (AWCC).

 **NOTE: If you have an Alienware Gaming desktop or laptop, you can directly access the AWCC.**

 **NOTE: For more information, see Alienware Command Center Online Help.**

## Prerequisites

Before installing the AWCC on a non-Alienware system:

- Ensure that the OS of your computer is Windows 10 R3 or later.
- Ensure your Internet connection is active.
- If you want to adjust the lighting effects, make sure to connect the Alienware monitor and the computer with the supplied USB 3.2 Gen 1 (5 Gbps) upstream cable.

## Installing AWCC through Windows update

1. When the monitor is first connected to a system where AWCC application is not installed, the application will be downloaded and installed on the system. The installation takes few minutes to complete.

 **NOTE: This process of downloading has dependency on the Internet connection.**

2. Navigate to the program folder to ensure that the installation is successful. Alternatively, you can find the AWCC application in the **Start** menu.
3. Connect your monitor to the system.
4. Restart OS.
5. Launch the AWCC.

 **NOTE: If you don't see the monitor appears on the AWCC Dashboard screen, go to OS Settings windows, click on Apps then Installed apps, look for Alienware Command Center Package Manager to add the packages.**

6. If the driver update is not responding in your computer, install AWCC from the Dell Support website.

## Installing AWCC from the Dell Support website

1. Visit Dell support site at [www.dell.com/support/drivers](http://www.dell.com/support/drivers), enter AW2725DF in the search box. You will be landed on the product support page.
2. Go to Drivers & Downloads. Download the latest version of the Alienware Command Center Application.
3. Navigate to the folder in which you saved the downloaded setup files.
4. Double-click the downloaded setup file and follow the on-screen instructions to complete the installation.

## Adjusting the lighting effects

1. Launch the AWCC application from the **Start** menu.
2. In the window of Dashboard view, click the monitor image of AW2725DF to access the device view.
3. Select the **LIGHTING** panel.
4. Specify the lighting zone(s) in the preview window.
5. Select an effect from the **LIGHTING EFFECT** dropdown list and configure the available options.

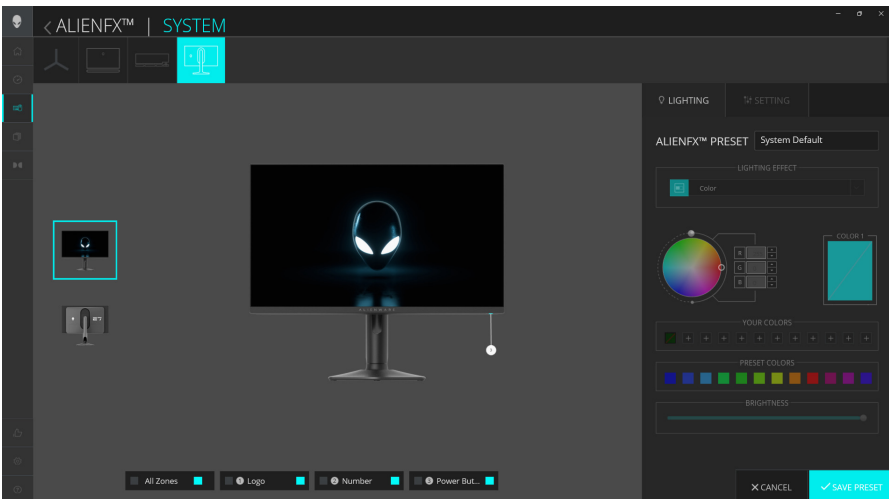

**NOTE:** The options displayed may vary depending on the lighting zone(s) and LIGHTING EFFECT you specified.



---

## Morph

---

The effect changes the light color into another through a seamless transition.

1. Pick a preferred color from the color palette or the list of **PRESET COLORS**. The selected color and its RGB color codes will be displayed in the right field.

 **NOTE: To change the color, use the up and down arrow buttons beside the R/G/B boxes to edit the color codes.**

2. To add the selected color to the list of **YOUR COLORS** for quick access in the future, click "+". At most 12 colors can be added to the list.

 **NOTE: To remove an existing color chip from the list, right-click on it.**

3. Repeat the previous steps to specify **COLOR 2** to be the ending light color.
4. Drag the **BRIGHTNESS** slider to adjust the brightness of the color.
5. Drag the **TEMPO** slider to adjust the transition speed.

---

## Pulse

---

The effect makes the light flash with a short pause.

1. Pick a preferred color from the color palette or the list of **PRESET COLORS**. The selected color and its RGB color codes will be displayed in the right field.

 **NOTE: To change the color, use the up and down arrow buttons beside the R/G/B boxes to edit the color codes.**

2. To add the selected color to the list of **YOUR COLORS** for quick access in the future, click "+". At most 12 colors can be added to the list.

 **NOTE: To remove an existing color chip from the list, right-click on it.**

3. Drag the **BRIGHTNESS** slider to adjust the brightness of the color.
  4. Drag the **TEMPO** slider to adjust the pulsing speed.
-

---

## Color

---

The lights will light in a single static color.

1. Pick a preferred color from the color palette or the list of **PRESET COLORS**. The selected color and its RGB color codes will be displayed in the right field.

 **NOTE: To change the color, use the up and down arrow buttons beside the R/G/B boxes to edit the color codes.**

2. To add the selected color to the list of **YOUR COLORS** for quick access in the future, click "+". At most 12 colors can be added to the list.

 **NOTE: To remove an existing color chip from the list, right-click on it.**

3. Drag the **BRIGHTNESS** slider to adjust the brightness of the color.
- 

## Breathing

---

The effect makes the light change from bright to dim.

1. Pick a preferred color from the color palette or the list of **PRESET COLORS**. The selected color and its RGB color codes will be displayed in the right field.

 **NOTE: To change the color, use the up and down arrow buttons beside the R/G/B boxes to edit the color codes.**

2. To add the selected color to the list of **YOUR COLORS** for quick access in the future, click "+". At most 12 colors can be added to the list.

 **NOTE: To remove an existing color chip from the list, right-click on it.**

3. Drag the **BRIGHTNESS** slider to adjust the brightness of the color.
  4. Drag the **TEMPO** slider to adjust the transition speed.
- 

## Spectrum

---

The effect makes the light change in the sequence of spectrum: red, orange, yellow, green, blue, indigo, and violet. You can drag the **TEMPO** slider to adjust the transition speed.

 **NOTE: The option is available only when you select All Zones to make lighting adjustments.**

---

## Static Default Blue

---

This effect makes the lights glow solid blue. You can drag the **BRIGHTNESS** slider to change the intensity of the color from strong to light.

 **NOTE: The option is available only when you select All Zones to make lighting adjustments.**

---

# Setting

1. Launch the AWCC application from the **Start** menu.
2. In the window of Dashboard view, click the monitor image of AW2725DF to access the device view.
3. Select the **SETTING** panel to customize the following features:
  - **Customization of AlienVision:** To customize vision mode features.
  - **Game configuration:** To adjust advanced gaming features.
  - **Display configuration:** To adjust the brightness and contrast of the display.
  - **PIP/PBP configuration:** To display images from different video sources.

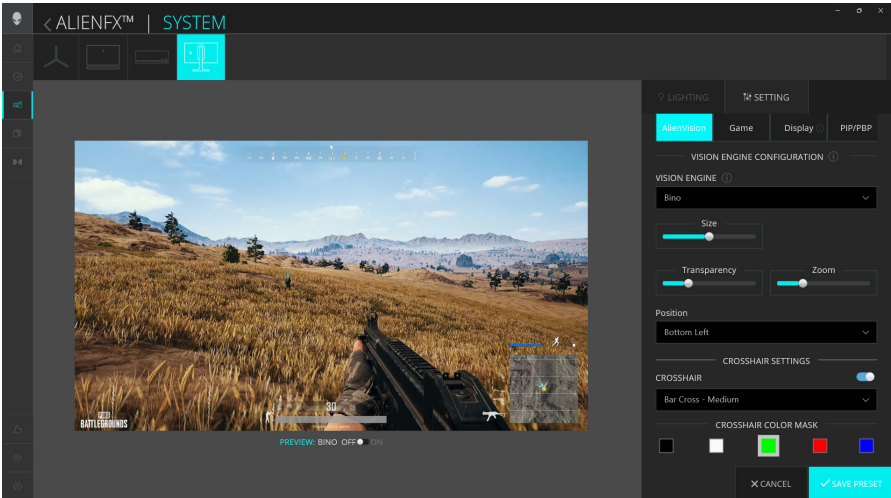





**NOTE:** When you save a Game Preset, only the settings for AlienVision and Game are stored.



## Customization of AlienVision

1. Click the **AlienVision** menu.
2. Select a vision mode from the **VISION ENGINE** dropdown list.
  - **Night:** Improves contrast and clarity during dark game scenes.
  - **Clear:** Improves and enhances the details and clarity in a day game scene.
  - **Bino:** Zoom in on distant objects like a telescope.
  - **Chroma:** Apply heatmap to differentiate game objects from the background.
  - **Crosshair:** Assist in aiming the target during challenging battles.

 **NOTE: To view the AlienVision effects during features customization, toggle the PREVIEW switch to the ON state.**

 **NOTE: Different product models may have different features supported.**

Feature	Description
<b>Size</b>	Drag the slider to enlarge the preview window or resume it to the default size.  <b>NOTE: This feature is not available for Crosshair.</b>
<b>Sharpness</b>	Drag the slider to adjust the sharpness level of the pictures in the preview window.  <b>NOTE: This feature is not available for Crosshair and Bino.</b>
<b>Zoom</b>	Drag the slider to adjust the zoom ratio of the close-up window, which displays a zoomed-in view of the object.  <b>NOTE: This feature is available only for Bino.</b>
<b>Transparency</b>	Drag the slider to adjust the transparency level of the close-up window.  <b>NOTE: This feature is available only for Bino.</b>
<b>Position</b>	Select a preferred position for the close-up window from the dropdown list.  <b>NOTE: This feature is available only for Bino.</b>

Feature	Description
<b>Heatmap</b>	Select a heatmap effect from the dropdown list and apply it on the in-game objects in the preview window.  <b>NOTE: This feature is available only for Chroma.</b>
<b>CROSSHAIR SETTINGS</b>	For <b>Night</b> , <b>Clear</b> , <b>Bino</b> , and <b>Chroma</b> modes, toggle the <b>CROSSHAIR</b> switch to turn on or off this feature. <ul style="list-style-type: none"> <li>▪ <b>CROSSHAIR:</b> Select a crosshair type that matches the gameplay from the dropdown list.</li> <li>▪ <b>CROSSHAIR COLOR MASK:</b> Select a preferred crosshair color.</li> </ul> Choose a crosshair mask effect from the dropdown list: <ul style="list-style-type: none"> <li>▪ <b>Static:</b> The crosshair color remains unchanged throughout the gameplay session.</li> <li>▪ <b>Adaptive:</b> When the crosshair is not visible with the background color, it automatically changes to a contrasting color. The crosshair color will remain unchanged until it becomes invisible with the background.</li> <li>▪ <b>Dynamic:</b> The crosshair color changes dynamically depending on the background color.</li> </ul>  <b>NOTE: The contrasting colors complement each other, such as white to black, red to cyan, green to magenta, and blue to yellow.</b>

### Toggle list

In the **TOGGLE LIST** section, you can select at least one or more vision engines to set up the **AlienVision** toggle list. You can toggle through the list during gameplay. You can set a shortcut key to easily switch between vision engines selected in the toggle list.

### Game configuration



Click the **Game** button to enhance your gameplay experience by using the provided features.

Feature	Description
<b>Dark Stabilizer</b>	Refer to <a href="#">Dark Stabilizer</a> .
<b>Game Enhance Mode</b>	Refer to <a href="#">Frame Rate</a> and <a href="#">Timer</a> .

 **NOTE:** For a better experience, always update to the latest version of the AWCC application.

## Display configuration

Click the **Display** button to adjust the display settings.

Feature	Description
<b>Brightness</b>	Drag the sliders to make the adjustment. Refer to <b>Brightness</b> and <b>Contrast</b> .
<b>Contrast</b>	 <b>NOTE:</b> These features may be grayed out depending on the current HDR state.
<b>Preset Modes</b>	Refer to <b>Preset Modes</b> .  <b>NOTE:</b> This feature is not available when HDR setting in the system is turned on and Smart HDR on the monitor is activated.
<b>Resolution/Refresh Rate</b>	Allows you to change the settings of resolution and refresh rate of the system.  <b>NOTE:</b> This feature is disabled when you set to duplicate screen on multiple monitors.

## PIP/PBP configuration

This feature allows you to display images from different video sources.

When you toggle the **PIP/PBP** switch to the ON state, the options of preset PBP or PIP modes are displayed under the preview window, and you can select your preferred mode.

Feature	Description
<b>Input Source</b>	Select video inputs for your <b>Main</b> window and <b>Sub</b> window.
<b>Contrast (Sub)</b>	Drag the slider to adjust the contrast level of the picture in the <b>Sub</b> window.
<b>Video Swap</b>	You can define the shortcut keys to swap video inputs between the main window and sub window.
<b>Change PIP Position</b>	You can define the shortcut keys to toggle through different preset PIP or PBP modes.

# Troubleshooting

**⚠ WARNING:** Before you begin any of the procedures in this section, follow the [Safety instructions](#).

## Self-test

Your monitor provides a self-test feature that allows you to check whether your monitor is functioning properly. If your monitor and computer are properly connected but the monitor screen remains dark, run the monitor self-test by performing the following steps:

1. Turn off both your computer and the monitor.
2. Unplug the video cable from the computer.
3. Turn on the monitor.

A dialog box should appear on the screen, indicating that the monitor is working correctly and it is not receiving a video signal. While in self-test mode, the power LED remains blue (default color).

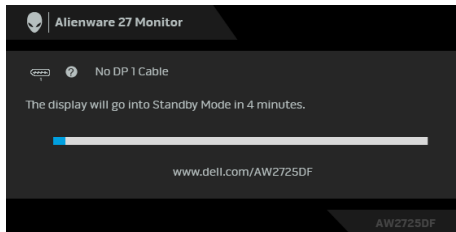

**✎ NOTE:** The message may be slightly different according to the connected input signal.

**✎ NOTE:** This dialog box also appears during normal operation, if the video cable is disconnected or damaged.

4. Turn off your monitor and reconnect the video cable; then turn on both your computer and the monitor.

After performing the above steps, if the monitor displays no video output, then the problem may be with the graphics card or the computer.

## Built-in diagnostics

Your monitor has built-in diagnostic tools that help you determine if the screen abnormality or audible noise you are experiencing is an inherent problem with your monitor.

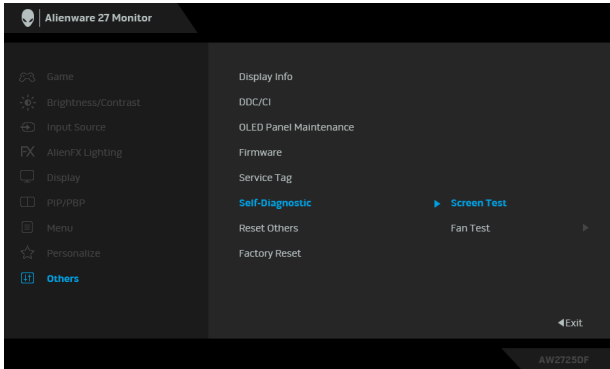

### Screen test

To run the test:

1. Move or press the joystick to launch the Menu Launcher.
2. Move the joystick up to select  and open the Main Menu.
3. Move the joystick to navigate and select **Others > Self-Diagnostic > Screen Test**.
4. Ensure that the screen is clean (no dust particles on the surface of the screen).
5. Press the joystick to initiate the built-in diagnostics. A gray screen is displayed.
6. Observe if the screen has any defects or abnormalities.
7. Toggle the joystick once again until a red screen is displayed.
8. Observe if the screen has any defects or abnormalities.

Repeat steps 7 and 8 until the screen displays green, blue, black, and white colors. Note any abnormalities or defects.

The test is complete when a text screen is displayed. To exit, toggle the joystick control again.

If you do not detect any screen abnormalities upon using the built-in diagnostic tool, the monitor is functioning properly. Check the video card and computer.



## Fan test

To run the test:

1. Move or press the joystick to launch the Menu Launcher.
2. Move the joystick up to select  and open the Main Menu.
3. Move the joystick to navigate and select **Others** > **Self-Diagnostic** > **Fan Test**.
4. Select **L1** to perform a 2-minute fan test. The fan speed of **L1** is about 985 RPM.

Once the test is complete, your monitor resumes normal fan operation to prevent any damage.

## Common problems

The following table contains general information about common monitor problems that you might encounter and the possible solutions:

Common symptoms	What you experience	Possible solutions
No video/power LED off	No picture	<ul style="list-style-type: none"><li>▪ Ensure that the video cable connecting the monitor and the computer is properly connected and secure.</li><li>▪ Verify that the power outlet is functioning properly using any other electrical equipment.</li><li>▪ Ensure that you have pressed the power button properly.</li><li>▪ Ensure that the correct input source is selected in the <b>Input Source</b> menu.</li></ul>
No video/power LED on	No picture or no brightness	<ul style="list-style-type: none"><li>▪ Increase brightness and contrast controls in the <b>Brightness/Contrast</b> menu.</li><li>▪ Perform monitor <b>self-test</b> feature check.</li><li>▪ Check for bent or broken pins in the video cable connector.</li><li>▪ Run the built-in diagnostics. For more information, see <b>Self-Diagnostic</b>.</li><li>▪ Ensure that the correct input source is selected in the <b>Input Source</b> menu.</li></ul>
Poor focus	Picture is fuzzy, blurry, or ghosting	<ul style="list-style-type: none"><li>▪ Eliminate video extension cables.</li><li>▪ Reset the monitor to factory settings. For more information, see <b>Factory Reset</b>.</li><li>▪ Change the video resolution to the correct aspect ratio.</li></ul>

Common symptoms	What you experience	Possible solutions
Shaky/jittery video	Wavy picture or fine movement	<ul style="list-style-type: none"> <li>▪ Reset the monitor to factory settings. For more information, see <a href="#">Factory Reset</a>.</li> <li>▪ Check environmental factors.</li> <li>▪ Relocate the monitor and test in another room.</li> </ul>
Missing pixels	OLED screen has spots	<ul style="list-style-type: none"> <li>▪ Cycle power On-Off.</li> <li>▪ Pixel that is permanently off is a natural defect that can occur in OLED technology.</li> <li>▪ For more information on Dell Monitor Quality and Pixel Policy, see <a href="http://www.dell.com/pixelguidelines">www.dell.com/pixelguidelines</a>.</li> </ul>
Stuck-on pixels	OLED screen has bright spots	<ul style="list-style-type: none"> <li>▪ Cycle power On-Off.</li> <li>▪ Pixel that is permanently off is a natural defect that can occur in OLED technology.</li> <li>▪ For more information on Dell Monitor Quality and Pixel Policy, see <a href="http://www.dell.com/pixelguidelines">www.dell.com/pixelguidelines</a>.</li> </ul>
Brightness problems	Picture too dim or too bright	<ul style="list-style-type: none"> <li>▪ Reset the monitor to factory settings. For more information, see <a href="#">Factory Reset</a>.</li> <li>▪ Adjust brightness and contrast controls in the <a href="#">Brightness/Contrast</a> menu.</li> </ul>
Geometric distortion	Screen not centered correctly	<p>Reset the monitor to factory settings. For more information, see <a href="#">Factory Reset</a>.</p>

Common symptoms	What you experience	Possible solutions
Horizontal/ vertical lines	Screen has one or more lines	<ul style="list-style-type: none"> <li>▪ Reset the monitor to factory settings. For more information, see <a href="#">Factory Reset</a>.</li> <li>▪ Perform monitor <a href="#">self-test</a> feature check and determine if these lines also appear in self-test mode.</li> <li>▪ Check for bent or broken pins in the video cable connector.</li> <li>▪ Run the built-in diagnostics. For more information, see <a href="#">Self-Diagnostic</a>.</li> </ul>
Synchronization problems	Screen is scrambled or appears torn	<ul style="list-style-type: none"> <li>▪ Reset the monitor to factory settings. For more information, see <a href="#">Factory Reset</a>.</li> <li>▪ Perform monitor <a href="#">self-test</a> feature check to determine if the scrambled screen appears in self-test mode.</li> <li>▪ Check for bent or broken pins in the video cable connector.</li> <li>▪ Restart the computer in the <i>safe mode</i>.</li> </ul>
Safety related issues	Visible signs of smoke or sparks	<ul style="list-style-type: none"> <li>▪ Do not perform any troubleshooting steps.</li> <li>▪ <a href="#">Contact Dell</a> immediately.</li> </ul>
Intermittent problems	Monitor malfunctions on and off	<ul style="list-style-type: none"> <li>▪ Ensure that the video cable connecting the monitor to the computer is connected properly and is secure.</li> <li>▪ Reset the monitor to factory settings. For more information, see <a href="#">Factory Reset</a>.</li> <li>▪ Perform monitor <a href="#">self-test</a> feature check to determine if the intermittent problem occurs in self-test mode.</li> </ul>

Common symptoms	What you experience	Possible solutions
Missing color	Picture missing color	<ul style="list-style-type: none"> <li>▪ Perform monitor <b>self-test</b> feature check.</li> <li>▪ Ensure that the video cable connecting the monitor to the computer is connected properly and is secure.</li> <li>▪ Check for bent or broken pins in the video cable connector.</li> </ul>
Wrong color	Picture color not good	<ul style="list-style-type: none"> <li>▪ Reset all settings under the <b>Game</b> menu to the factory defaults using <b>Reset Game</b>.</li> <li>▪ Change the <b>Input Color Format</b> to <b>RGB</b> or <b>YCbCr/YPbPr</b> in the <b>Display</b> settings OSD.</li> <li>▪ Run the built-in diagnostics. For more information, see <b>Self-Diagnostic</b>.</li> </ul>
Wrong color in HDR mode	Color banding in the pictures	Try to lower down the frequency (DP: 2560 x 1440 at 60 Hz, HDMI: 2560 x 1440 at 60 Hz).
Screen image is too small	Image is centered on screen, but does not fill entire viewing area	<ul style="list-style-type: none"> <li>▪ Check the <b>Aspect Ratio</b> settings in the <b>Display</b> menu OSD.</li> <li>▪ Reset the monitor to factory settings. For more information, see <b>Factory Reset</b>.</li> </ul>
Cannot adjust the monitor with the joystick	OSD does not appear on the screen	<ul style="list-style-type: none"> <li>▪ Turn off the monitor, unplug the power cord, plug it back, and then turn on the monitor.</li> <li>▪ Check whether the OSD menu is locked. If yes, move and hold the joystick forward/back/left/right for 4 seconds to unlock. For more information, see <b>Locking the control buttons</b>.</li> </ul>

Common symptoms	What you experience	Possible solutions
No input signal when user controls are pressed	No picture, the LED light is blue	<ul style="list-style-type: none"> <li>▪ Check the signal source. Ensure that the computer is not in the power saving mode by moving the mouse or pressing any key on the keyboard.</li> <li>▪ Check whether the signal cable is plugged in properly. Re-plug the signal cable if necessary.</li> <li>▪ Reset the computer or video player.</li> </ul>
The picture does not fill the entire screen	The picture cannot fill the height or width of the screen	<ul style="list-style-type: none"> <li>▪ Due to different video formats (aspect ratio), the monitor may display in full screen.</li> <li>▪ Run the built-in diagnostics. For more information, see <a href="#">Self-Diagnostic</a>.</li> </ul>
The displayed pictures appear incorrectly when the DP/HDMI cable is connected through a USB-C adapter or dock to your laptop or desktop	Display will freeze, has black screen or display abnormal screen	Do not use a USB-C adapter or dock. Connect the DP/HDMI cable directly to your laptop or desktop.

Common symptoms	What you experience	Possible solutions
Screen flickering	There is some noticeable flickering in the displayed pictures	<ul style="list-style-type: none"> <li>▪ Use the native resolution of your monitor (2560 x 1440 at 60 Hz) or higher refresh rate.</li> <li>▪ If the variable refresh rate (VRR) of your device is turned on, turn off variable refresh rate (VRR).</li> <li>▪ If you are using an NVIDIA graphics card and G-Sync is turned on, turn off G-Sync.</li> <li>▪ If you are using an AMD graphics card and Free-Sync is turned on, turn off Free-Sync.</li> <li>▪ Update the graphics card driver and firmware to the latest version.</li> <li>▪ Change the cable connecting the monitor to the computer. A defective cable can cause the signal to break while being transmitted across the wire.</li> <li>▪ Check the surroundings. Electromagnetic fields can cause screen flickering. If there is another device plugged into the same power strip as the monitor, try to remove it.</li> </ul>
Image retention from a static image left on the monitor for a long period of time	Faint shadow from the static image displayed appears on the screen	<ul style="list-style-type: none"> <li>▪ Set the screen to turn off after a few minutes of screen idle time. These can be adjusted in Windows Power Options or Mac Energy Saver setting.</li> <li>▪ Alternatively, use a dynamically changing screensaver.</li> </ul>
Unevenness in luminance or color of the screen images	Visible spots (bright or dark) or lines or Mura appear on the screen	<ul style="list-style-type: none"> <li>▪ Perform the function of <b>Pixel Refresh</b> or <b>Panel Refresh</b>. For more information, see <a href="#">OLED Panel Maintenance</a>.</li> </ul>

Common symptoms	What you experience	Possible solutions
<p>In the <b>HDR Peak 1000</b> mode, the displayed images are dimmer than they are in the <b>DisplayHDR True Black</b> mode</p>	<p>The <b>HDR Peak 1000</b> mode is ideal for the HDR content with a peak brightness of 1000 nits. When displaying non-HDR content, such as browsers and editors, the brightness level in the <b>HDR Peak 1000</b> mode is observed to be lower as compared to that in the <b>DisplayHDR True Black</b> mode due to the luminance control method of OLED panels.</p>	<ul style="list-style-type: none"> <li>▪ For displaying non-HDR content, such as Office applications, disable the HDR display feature in Windows display settings.</li> <li>▪ For displaying HDR videos or games with a maximum peak brightness of 1000 nits, set <b>Smart HDR</b> to <b>HDR Peak 1000</b>.</li> <li>▪ For displaying HDR videos or games which meet the DisplayHDR 400 True Black standard, set <b>Smart HDR</b> to <b>DisplayHDR True Black</b>.</li> </ul>
<p>Pixel shifting occurs</p>	<p>The image on the screen moves slightly sometimes.</p>	<p>Pixel shift is a function that moves the pixels of the screen to prevent image retention on QD-OLED panels. It does not influence your viewing experience.</p>
<p>Cannot select 10-bit color</p>	<p>Unable to select 10-bit color from the connected computer</p>	<ul style="list-style-type: none"> <li>▪ If your computer is equipped with an NVIDIA graphics card, go to <b>NVIDIA control panel &gt; Resolutions &gt; Output Color Depth</b>, select <b>10 bpc</b> (bits per color) from the <b>Color Depth</b> drop-down menu, and click <b>Apply</b>.</li> <li>▪ For your computer is equipped with an AMD graphics card, go to <b>AMD RADEON PRO AND AMD FIREPRO SETTINGS &gt; Display &gt; Color Depth</b>, and select 10 bpc from the drop-down list.</li> </ul>



<b>Common symptoms</b>	<b>What you experience</b>	<b>Possible solutions</b>
Cannot adjust the lighting using AWCC	Unable to configure the features under <b>LIGHTING</b> panel	Ensure that the supplied USB 3.2 Gen 1 (5 Gbps) upstream cable is properly connected to your monitor and computer.
Cannot adjust the gaming features using AWCC	No <b>SETTING</b> panel	<ul style="list-style-type: none"> <li>▪ Check whether the signal cable is plugged in properly. Re-plug the signal cable as necessary.</li> <li>▪ Reboot your computer.</li> </ul>

## Product specific problems

<b>Specific symptoms</b>	<b>What you experience</b>	<b>Possible solutions</b>
Abnormal thermal behavior	An error message appears on the screen	<ul style="list-style-type: none"> <li>▪ Ensure that the monitor vents are not blocked.</li> <li>▪ Use the compressed air to clear the dust particles or dirt from the vents.</li> <li>▪ Refresh/update the monitor firmware.</li> <li>▪ <a href="#">Contact Dell</a> for support.</li> </ul>

## Universal Serial Bus (USB) specific problems

Specific symptoms	What you experience	Possible solutions
USB interface is not working	USB peripherals are not working	<ul style="list-style-type: none"><li>▪ Check that your monitor is turned on.</li><li>▪ Reconnect the upstream cable to your computer.</li><li>▪ Reconnect the USB peripherals (downstream connector).</li><li>▪ Turn off and then turn on the monitor again.</li><li>▪ Reboot your computer.</li><li>▪ Some USB devices like external portable HDD require higher electric current; connect the device directly to the computer system.</li></ul>
SuperSpeed USB 5 Gbps (USB 3.2 Gen 1) interface is slow	SuperSpeed USB 5 Gbps (USB 3.2 Gen 1) peripherals working slowly or not working at all	<ul style="list-style-type: none"><li>▪ Check that your computer is SuperSpeed USB 5 Gbps (USB 3.2 Gen 1)-compatible.</li><li>▪ Some computers have USB 3.2 and USB 2.0 ports. Ensure that the correct USB port is used.</li><li>▪ Reconnect the upstream cable to your computer.</li><li>▪ Reconnect the USB peripherals (downstream connector).</li><li>▪ Reboot your computer.</li></ul>
Wireless USB peripherals stop working when a USB 3.2 device is plugged in	Wireless USB peripherals responding slowly or only working as the distance between themselves and their receiver decreases	<ul style="list-style-type: none"><li>▪ Increase the distance between the USB 3.2 peripherals and the wireless USB receiver.</li><li>▪ Position your wireless USB receiver as close as possible to the wireless USB peripherals.</li><li>▪ Use a USB-extender cable to position the wireless USB receiver as far away as possible from the USB 3.2 port.</li></ul>

---

<b>Specific symptoms</b>	<b>What you experience</b>	<b>Possible solutions</b>
Wireless USB mouse does not work properly	When plugged to one of the USB ports on the rear side of the monitor, the Wireless USB mouse lags or freezes during use	Unplug the Wireless USB Mouse receiver and re-plug it into an appropriate Quick Access USB ports at the bottom of the monitor.

---

# Regulatory information

## **FCC notices (U.S. only) and other regulatory information**



For FCC notices and other regulatory information, see the regulatory compliance website located at [www.dell.com/regulatory\\_compliance](http://www.dell.com/regulatory_compliance).

## **EU product database for energy label and product information sheet**

AW2725DF: <https://eprel.ec.europa.eu/qr/1833147>

# Contacting Dell

To contact Dell for sales, technical support, or customer service issues, see [www.dell.com/contactdell](http://www.dell.com/contactdell).

-  **NOTE: Availability varies by country and product, and some services may not be available in your country.**
-  **NOTE: If you do not have an active internet connection, you can find contact information on your purchase invoice, packing slip, bill, or Dell product catalog.**